

30-Inch Gas Range

\$4,499 | TRANSITIONAL

dacor



DOP30T840GS/DA - Silver Stainless, Natural Gas/Liquid Propane

Features & Benefits

- Dual Four-Part Pure convection system
- Simmersear™ brass burners
- OLED control panel with SmartThings Wi-Fi connectivity
- Auto Connect to compatible ventilation through Bluetooth
- Air sous vide
- Digital temperature probe
- Self-clean oven
- Perma-Flame
- Softshut™ hinges
- LP conversion kit
- Voice commands through Bixby/Alexa/Google

Controls

CONTROL TYPE	2.25" PMOLED Touchscreen & Knobs
ILLUMINA™ KNOBS	White
WI-FI + SMARTTHINGS	Yes
BLUETOOTH AUTO CONNECT™ VENTILATION	Yes
CONTROL SHOWER LIGHTING	No
CLOCK	Yes
DELAY START	Yes
KITCHEN TIMER	Yes
CHILD LOCK	Yes
SABBATH MODE	Yes

Oven

OVEN CAPACITY (CU. FT.)	6
CONVECTION	Four-Part Pure Convection
BAKE BURNER	18,000 BTU
BROIL BURNER	16,500 BTU
CONVECTION ELEMENT	900W
TEMPERATURE PROBE	Yes
LIGHTING	Halogen
SELF-CLEAN	Self-Clean
SOFTSHUT™	Yes

Cooktop

NUMBER OF BURNERS	4
PERMA-FLAME™ (AUTO RE-IGNITION)	Yes
LEFT FRONT (BTU)	16,000
LEFT REAR (BTU)	16,000
RIGHT FRONT (BTU)	20,000
RIGHT REAR (BTU)	9,500
GRIDDLE	Sold Separately
WOK RING	Yes

Weights & Dimensions

NET WEIGHT (LBS.)	238
SHIPPING WEIGHT (LBS.)	265
PRODUCT DIMENSIONS (W x H x D IN INCHES)	29 15/16 x 36 1/8 x 27 1/8

Technical Details

ELECTRICAL REQUIREMENT	120V, 60 Hz, 40A
AVAILABLE FUEL TYPES	Natural Gas, Liquid Propane
LP CONVERSION KIT (INCLUDED)	Yes

Accessories (Optional)

ARG30	Griddle for 30" Range	\$349
--------------	-----------------------	-------

30-Inch Gas Range

\$4,499 | TRANSITIONAL



Product Dimensions

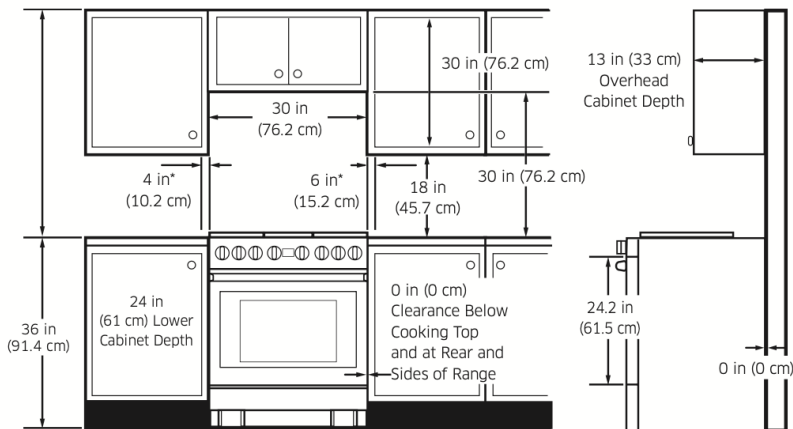
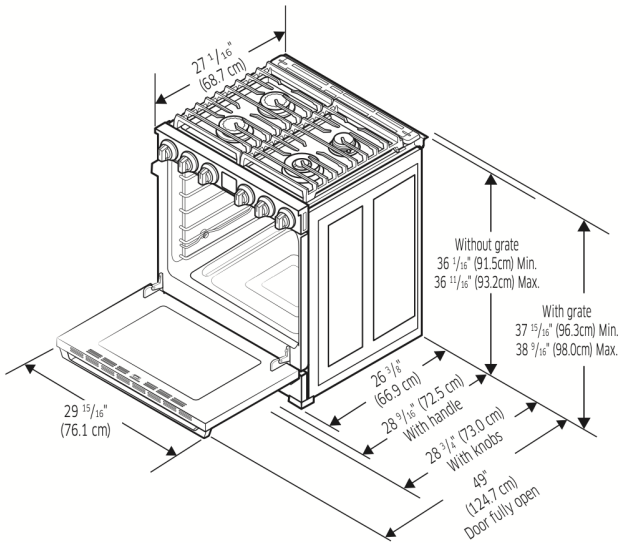

* Side clearance above cooking surface to any objects, i.e., wall.