

Operating and Installation Instructions

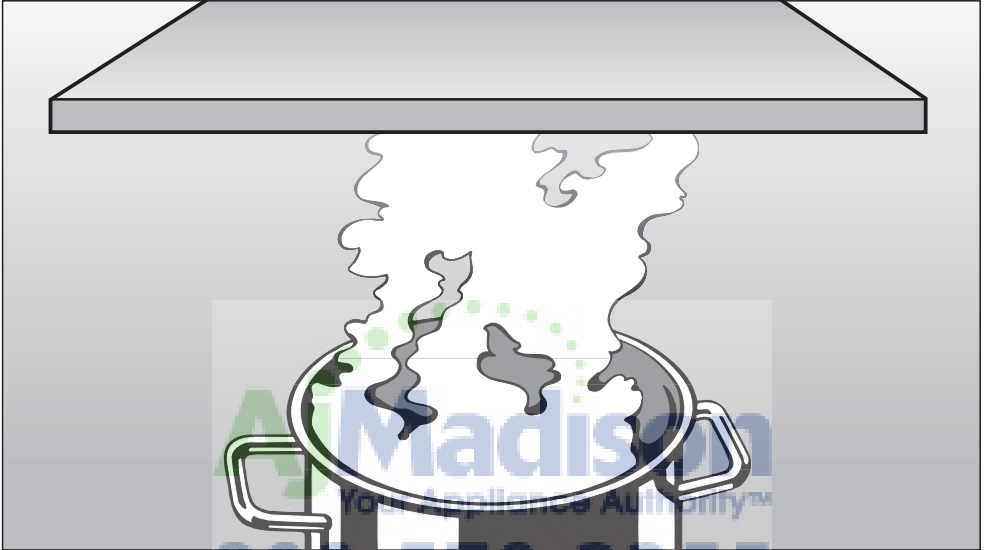

Ventilation System DA 6290 W

To prevent accidents
and appliance damage,
read these instructions

before

installation or use.

en - US, CA

M.-Nr. 07 851 420

Contents

IMPORTANT SAFETY INSTRUCTIONS	3
Functional description	7
Guide to the Ventilation System	8
Operation	10
Turning on the fan ①	10
Selecting the power level - / +	10
Intensive setting "IS"	10
Delayed Shut Down 5 ⌚ 15	11
Overhead lighting ☉	11
Glass edge lighting ☾	12
Changing the color of the glass edge lighting ☾	12
Filter timer 🕒	13
Cleaning and Care	15
Cleaning the casing	15
Grease filter	16
Resetting the grease filter timer	17
Active charcoal filter	18
Resetting the charcoal filter timer	18
Changing the light bulbs	19
After Sales Service	20
Installation instructions	21
Caring for the environment	23
Appliance dimensions	24
Structural support	28
Installation	29
Installation instructions	29
Protective film	29
Dismantling	29
Installation material	30
Air extraction	32
Electrical connection	34
Technical data	35

IMPORTANT SAFETY INSTRUCTIONS

READ AND SAVE THESE INSTRUCTIONS

Keep these instructions in a safe place and pass them on to any future user.

Read these instructions carefully before installing or using the Ventilation System.

► This appliance is intended for residential use only. Use the appliance only for its intended purpose.

► This appliance complies with current safety requirements. Improper use of the appliance can lead to personal injury and material damage.

⚠ CAUTION
For General Ventilating Use Only. Do Not Use To Exhaust Hazardous Or Explosive Materials And Vapors.

► This appliance is designed to vent cooking smoke and odors only.

► This appliance is suitable for installation above gas or electric cooking surfaces.

► This appliance is not designed for maritime use or for use in mobile installations such as recreational vehicles or aircraft. However, under certain conditions installation in these applications may be possible. Please contact your Miele dealer or the Miele Technical Service Department with specific requirements.

⚠ WARNING
TO REDUCE THE RISK OF FIRE, ELECTRIC SHOCK, OR INJURY TO PERSONS, OBSERVE THE FOLLOWING:

► a) Use this appliance only in the manner intended by the manufacturer. If you have questions, contact Miele.

► b) Before servicing or cleaning the appliance, switch power off at the service panel and lock the service disconnecting means to prevent power from being switched on accidentally. If the service disconnecting means cannot be locked, securely fasten a prominent warning device, such as a tag, to the service panel.

► c) Be certain your appliance is properly installed and grounded by a qualified technician. To guarantee the electrical safety of this appliance, continuity must exist between the appliance and an effective grounding system. It is imperative that this basic safety requirement be met. If there is any doubt, have the electrical system of the house checked by a qualified electrician.

IMPORTANT SAFETY INSTRUCTIONS

▶ d) Before connecting the appliance to the power supply make sure that the voltage and frequency listed on the data plate correspond with the household electrical supply. This data must correspond to prevent appliance damage. If in doubt consult a qualified electrician.

▶ e) Installation work and repairs should only be performed by a qualified technician in accordance with all applicable codes and standards. Repairs and other work by unqualified persons could be dangerous.

▶ f) Only open the housing as described in the enclosed "Installation diagram" and in the "Cleaning and care" section of this manual. Under no circumstances should any other parts of the housing be opened. Tampering with electrical connections or components and mechanical parts is highly dangerous to the user and can cause operation faults.

▶ g) Before discarding an old appliance, disconnect it from the power supply and remove the power cord to prevent hazards.

Use

WARNING **TO REDUCE THE RISK OF A COOKTOP GREASE FIRE:**

▶ a) Never leave surface units unattended at high settings. Boilovers cause smoking and greasy spillovers may ignite. Heat oils slowly on low or medium settings.

▶ b) Always turn the hood on when cooking at a high heat.

▶ c) Clean the ventilation hood frequently. Grease should not be allowed to accumulate on the fan or filter.

▶ d) Use the proper pan size. Always use cookware appropriate for the size of the cooking area.

▶ e) Do not flambé or grill with an open flame beneath the hood. Flames could be drawn up into the hood by the suction and the grease filters may catch fire.

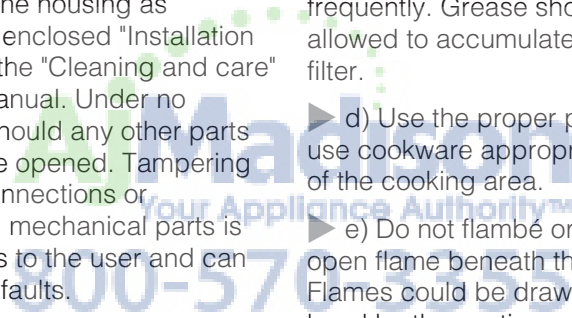

IMPORTANT SAFETY INSTRUCTIONS

⚠ WARNING
TO REDUCE THE RISK OF INJURY TO PERSONS IN THE EVENT OF A COOKTOP GREASE FIRE, OBSERVE THE FOLLOWING*:

▶ a) **SMOTHER FLAMES** with a close fitting lid, cookie sheet, or metal tray then turn off the burner.

BE CAREFUL TO PREVENT BURNS. If the flames do not go out immediately, **EVACUATE AND CALL THE FIRE DEPARTMENT.**

▶ b) **NEVER PICK UP A FLAMING PAN** - You may be burned.

▶ c) **DO NOT USE WATER**, including wet dishcloths or towels - a violent steam explosion will result.

▶ d) Use a fire extinguisher **ONLY** if:

- 1) You have a class ABC extinguisher, and you know how to operate it.
- 2) The fire is small and contained in the area where it started.
- 3) The fire department is being called.
- 4) You can fight the fire with your back to an exit.

▶ Do not allow children to play with or operate the appliance or its controls. Supervise its use by the elderly or infirm.

▶ Always turn on the hood when using the cooktop to prevent damage from condensation.

▶ Never operate gas burners without cookware. Turn the burner off when not in use. Adjust the burner so that the flames do not extend beneath the cookware. Do not overheat the cookware, e.g. when using a wok. The hood can be damaged due to excessive heat from the burners and the cookware.

▶ Do not use the hood without the grease filters in place.

▶ Do not use a steam cleaner to clean the hood. Steam could penetrate electrical components and cause a short circuit.

* Based on "Kitchen Firesafety Tips" published by NAFTA

IMPORTANT SAFETY INSTRUCTIONS

Installation

⚠ WARNING
TO REDUCE THE RISK OF
FIRE, ELECTRIC SHOCK, OR
INJURY TO PERSONS,
OBSERVE THE FOLLOWING:

- ▶ a) Installation work and electrical wiring must be done by qualified person(s) in accordance with all applicable codes and standards, including fire-rated construction.
- ▶ b) Sufficient air is needed for combustion and exhausting of gases through the flue (chimney of fuel burning equipment to prevent back drafting. Follow the heating equipment manufacturer's guideline and safety standards such as those published by the National Fire Protection Association (NFPA) and the American Society for Heating, Refrigeration and Air Conditioning Engineers (ASHRAE), and the local code authorities.
- ▶ c) When cutting or drilling into the wall or ceiling, do not damage electrical wiring and other hidden utilities.
- ▶ d) Ducted hoods must always be vented to the outdoors.
- ▶ e) Do not use this hood with any solid-state speed control device.
- ▶ f) Do not use an extension cord to connect the appliance to electricity. Extension cords do not guarantee the required safety of the appliance, (e.g. danger of overheating).

▶ g) Do not install this hood over cooktops that burn solid fuel.

▶ h) Provided a larger distance is not given by the manufacturer of the cooktop, follow the minimum safety distances between a cooktop and the bottom of the hood given in the "Appliance dimensions" section of this manual.

If local building codes require a greater safety distance, follow their requirement.

If there is more than one appliance beneath the hood and they have different minimum safety distances always select the greater distance.

▶ i) Never connect an exhaust hood to an active chimney, dryer vent, vent flue, or room ventilating ductwork.

▶ j) Seek professional advice before connecting an exhaust hood vent to an existing, inactive chimney or vent flue.

▶ k) Any fittings, sealant, or materials used to install the ductwork must be made of approved non-flammable materials.

⚠ WARNING
TO REDUCE THE RISK OF
FIRE USE ONLY METAL
DUCTWORK.

Functional description

The hood offers two modes of operation:

Air extraction

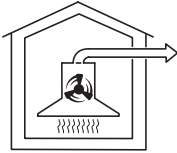

The air is drawn in and cleaned by the grease filters and directed outside.

The hood comes equipped with a **non-return flap**. This flap automatically closes when the hood is turned off so that no exchange of outside air and room air can occur. When the hood is turned on, the air pressure of the exhaust fan automatically opens the flap blowing the inside air and cooking odors outside.

Recirculation mode



Air is drawn through the grease filters and an **active charcoal filter**. The filtered air is then recirculated back into the kitchen through a vent at the top of the hood's chimney.

The recirculation mode requires an install kit and charcoal filter which are optional accessories.

Before using the hood in recirculation mode, ensure that the active charcoal filter is in place, see "Cleaning and care".

800-570-3355

Guide to the Ventilation System

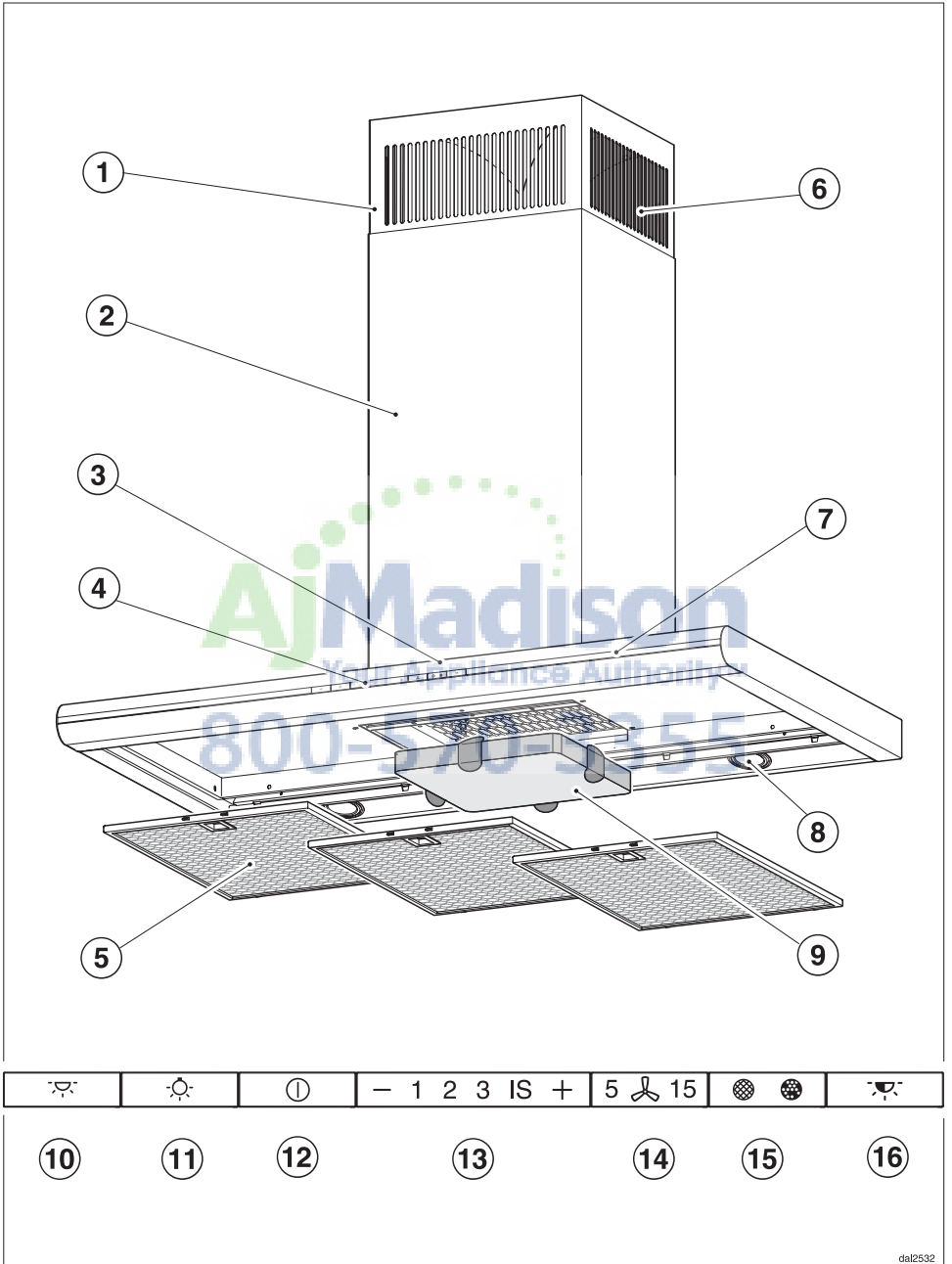

dal2532

Guide to the Ventilation System

① Chimney extension

② Chimney

③ Canopy

④ Control panel

⑤ Grease filter

⑥ Recirculation vent

(recirculation mode only)

⑦ Glass edge lighting

⑧ Overhead lighting

⑨ Charcoal filter

(optional accessory for recirculation mode)

⑩ On/Off button for the glass edge lighting

⑪ On/Off button for the overhead lighting

This button turns the light on and off and also dims the light.

⑫ On/Off button

⑬ Fan power selection

⑭ Delayed shut down

This button activates the Delayed Shut Down feature. The fan can be set to turn off automatically after either 5 or 15 minutes.

⑮ Filter button

The indicator  of the grease filter button lights when the grease filters need to be cleaned.

The indicator  next to the charcoal filter button lights when the charcoal filter needs to be replaced. When first using the system, the operating hours timer must be activated.

This button can be used at any time to reset the applicable timer after cleaning the grease filters or changing the charcoal filter (see "Cleaning and Care").

You can also check or change the number of hours.

⑯ Color change button

This button is used to change the color of the glass edge lighting.

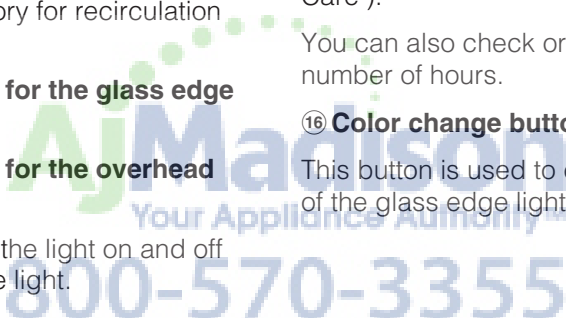

Operation

Turning on the fan ①

- Press the On/Off button ①.

The fan turns on to Level **2**, the ① symbol and the **2** of the power level indicator lights up.

Selecting the power level – / +

- Press the "–" symbol to select a lower power level or the "+" symbol for a higher power level.

Depending on the amount of cooking odors, levels **1** to **3** are usually sufficient for normal cooking.



Intensive setting "IS"

To remove strong aromas or odors, for example when frying, select power level **IS** temporarily.

Automatically switching back the intensive power level

The intensive level can be programmed to automatically switch back to level **3** after 10 minutes.

- Turn the fan and the overhead lighting off.
- Press and hold the "Delayed shut down" button **5**  **15** for approx. 10 seconds until power level indicator **1** lights up.
- Then press the following buttons one after another :

- light ,
- the "–" button, and
- the light button  again.

If the indicators **1** and **IS** flash, the automatic switch back is not activated.

- To activate the automatic switch back, press the "+" button. The power level indicators **1** and **IS** light continuously. To deactivate, press the "–" button.
- To save the setting, press the "Delayed shut down" button **5** .

If the procedure is not stored within 4 minutes, the hood will automatically default to the original setting



Delayed Shut Down 5 15



For both air extraction and recirculation, it is recommended that run the fan for several minutes after cooking is completed.

This helps clear the kitchen air of any remaining vapors and odors.

The Delayed Shut Down feature can be selected to turn the fan off automatically after a preselected length of time.

■ After cooking, and with the fan on, press the Delayed Shut Down button **5  15** :

- once: the fan automatically turns off after 5 minutes (**5  15** lights up).
- twice: the fan automatically turns off after 15 minutes (** 15** lights up).

If you press the Delayed Shut Down button **5  15** again, the fan will not turn off automatically (**5  15** goes out).

Turning off the fan

■ Press the On/Off button to turn the fan off .

The  indicator goes out.

Overhead lighting

The overhead lighting can be turned on and off independently of the fan.

■ Press the light button  briefly to turn on the lighting.

The  light button indicator illuminates.

The overhead lighting comes on at maximum brightness.

Dimming the overhead lighting

The brightness of the lighting can be adjusted.

■ While the lighting is turned on, press and hold the light button . The lighting will dim until the button is released.

■ If the button  is pressed and held down again, the lighting will brighten until the button is released.

If the  button is pressed continuously, the lighting will cycle between light and dark.

Turning the overhead lighting off

■ Briefly press the light button  to turn off the lighting.

■ The  indicator goes out.

Operation



Glass edge lighting

- Press the button for the glass edge lighting  to have the glass edge lit from behind. It can be turned on and off independently of the fan and overhead lighting.

Changing the color of the glass edge lighting

The color of the glass edge lighting can be changed as desired.

White is the preset color.

- Turn on the glass edge lighting .
- Six factory-set colors can be called up by pressing the color change button  repeatedly:
 - ① White
 - ② Green
 - ③ Red
 - ④ Blue
 - ⑤ Rapid color sequence
The light color changes continuously. All colors are cycled through once every minute. Initially, the button indicator flashes rapidly.
 - ⑥ Slow color sequence
Operates the same above, but the colors rotate once every 15 minutes. Initially, the button indicator flashes slowly.

A selected light color can be saved.

To select the color:

- Select the rapid or slow color sequence (color setting ⑤ or ⑥).

The continuous color changes start.

- When the desired color is reached, press and hold the color change button  until the glass edge lighting flashes three times.

This light color is now saved as an additional color setting ⑦.

- It can be selected at any time until a new color is saved in the same way.
- To turn it off, press the button for the glass edge lighting . The lighting turns off after a short delay.

The next time you turn it on, the last active color setting ① to ⑦ is selected.



Automatic Safety Shut-Off

The fan will turn automatically off 10 hours of use. The lighting however will remain on.

- Press the On/Off button ① to turn the fan back on again.

Filter timer

A timer records the hours of fan operation.

The filter timer will signal that the grease filter  or the charcoal filter  needs to be cleaned or changed.





See the "Cleaning and care " chapter for information on cleaning filters and resetting the timer.

Reprogramming the filter timer

The timer may be set to suit your cooking habits.

- If you often roast and fry foods, choose a shorter operating time.
- If you tend to cook fat-free, choose a longer operating time.
- If you cook only occasionally, it is better to choose a shorter operating time. This is because accumulated grease will harden over time, making cleaning difficult.

The factory setting for the grease filter timer is 30 hours. You can adjust the time to 20, 30, 40 or 50 hours.

- Press the On/Off button  to turn off the fan.
- Press the Delayed Shut Down **5**  **15** and filter button   at the same time.

The indicator for the grease filter timer  and one of the power level indicators will flash.



The **1** to **IS** indicators show the programmed time:

Indicator **1** = 20 hours

Indicator **2** = 30 hours

Indicator **3** = 40 hours

Indicator **IS** = 50 hours

- Press the "-" symbol to select a shorter operating time or the "+" symbol for a longer one.
 - Store the selection by pressing the filter button  .
- All the lights will go out.

If the procedure is not stored within 4 minutes, the hood will automatically default to the original setting.

Operation



Activating and reprogramming the Charcoal filter timer

(in recirculation mode)

The charcoal filter is needed for recirculation mode.

The charcoal filter timer is **not preset**.

Before using the hood in recirculation mode, the charcoal filter timer must be programmed.

- Press the On/Off  control to switch the fan off.
- Press the **+** symbol and the filter timer button  at the same time.

The charcoal filter symbol  and one of the fan power levels flash.

The **1** to **IS** indicators show the programmed time:

Indicator **1** = 120 hours

Indicator **2** = 180 hours

Indicator **3** = 240 hours

Indicator **IS** = Deactivated





- Press the **-** symbol to select a shorter operating time, or the **+** symbol to select a longer operating time.
- Confirm the selection by pressing the filter timer button .

All the indicator lights will go out.

If the procedure is not stored within 4 minutes, the hood will automatically default to the original setting.

Reading the filter operating hours counter

To check the percentage of time set already used

- Press the On/Off control  to switch the fan on.
- Press and hold the filter button   :
 - Once, to read the Grease filter operating hours. The Grease filter symbol  lights up.
 - Twice, to read the Charcoal filter operating hours. The Charcoal filter symbol  lights up.

One or more of the power level indicators will flash.

The number of flashing "**-/+**" indicators show the percentage of programmed hours that have been used.

Indicator **1** = less than 25 %

Indicator **2** = less than 50 %

Indicator **3** = less than 75 %

Indicator **IS** = less than 100 %

This information will remain stored in memory in the event of a power failure.

⚠ WARNING
TO REDUCE THE RISK OF
FIRE, ELECTRIC SHOCK, OR
INJURY TO PERSONS,
OBSERVE THE FOLLOWING:

Before cleaning or servicing the hood, disconnect it from the power supply, see "Important Safety Instructions".

Cleaning the casing

Never use abrasive cleaners, scouring pads, steel wool or caustic (oven) cleaners on the hood. They **will** damage the surface.

- All external surfaces and controls can be cleaned with a mild solution of warm water and liquid dish soap applied with a soft sponge.

Do not use too much water when cleaning the controls. Water could penetrate the electronics and cause damage.

- Wipe dry using a soft cloth.

Avoid:

- cleaning agents containing soda, acids or chlorides,
- abrasive cleaning agents e.g. powder or cream cleansers,
- abrasive sponges, e.g. pot scourers or sponges which have been previously used with abrasive cleaning agents.

These will damage the surface.

The following instructions for cleaning "Stainless steel" surfaces and "Stainless steel colored controls" should be followed **in addition to** the general "Cleaning the casing" instructions.

Special instructions for stainless steel surfaces

(not applicable to the controls)

Stainless steel surfaces can be cleaned using a non-abrasive stainless steel cleaner.

To help prevent resoiling, a conditioner for stainless steel can be applied.

Special instructions for colored casings (RAL)

(Special order)

It is very difficult to clean this type of surface without causing minor marks to the surface material. This can become particularly noticeable with darker colors and if there is halogen lighting in the kitchen.

Cleaning and Care

Stainless steel colored controls

These controls may become discolored or damaged if not cleaned regularly.
Do not use a stainless steel cleaner on these controls.

Glass edge

- The glass edge can be cleaned using a household glass cleaner.

Avoid using sharp metal scrapers and oven spray.

Grease filter

The reusable metal grease filters in the hood remove solid particles from the vented kitchen air (grease, dust, etc) and prevent soiling of the ventilation system.

The grease filters should be cleaned every 3 - 4 weeks or when the grease filter indicator lights.

 A dirty filter is a fire hazard!

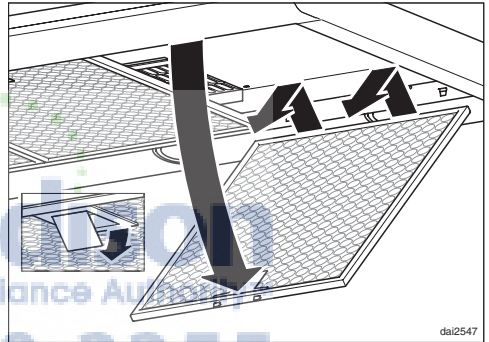

- To remove the grease filter pull the locking clips forward, lower the filter down 45°, unhook it at the rear, and take it out.

Support the grease filter so that it does not fall and damage the cooktop.

Cleaning the grease filters

- **By hand:** use a scrub brush with a solution of warm water and mild dish soap.

Do not use the pure detergent, aggressive all purpose cleaners, oven sprays, abrasive cleaning agents or limescale removers. They could damage the filter.

- **In a dishwasher:** place the filter vertically in the lower basket, making sure that the spray arm is not blocked.

Use a wash program with a max. temperature of 150°F (65°C). In a Miele dishwasher use the "Normal" program.

Use the recommended amount of dishwasher detergent. Overuse could destroy the filter.

Depending on the detergent, cleaning the grease filters in a dishwasher may cause permanent discoloration of the filter surface. Filter performance will not be affected by this discoloration.

- After cleaning, place the filters on a towel to air dry.
- While the filters are removed, clean any dirt or grease from the filter casing.

- When putting the grease filters back make sure that the locking clips are visibly facing the cooking surface

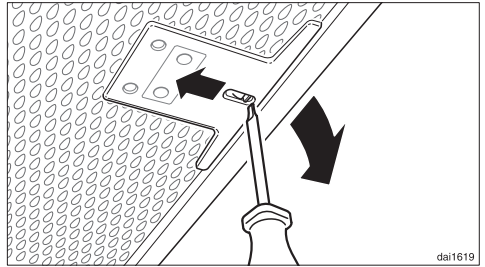

- If the filters are incorrectly installed, insert a small screwdriver into the slit along its edge to disengage it from the casing.

Resetting the grease filter timer

After cleaning, reset the grease filter timer.

- With the fan running, press and hold the grease filter button  for approx. 3 seconds, until only the **1** is flashing. The indicator light will  go out.

If the grease filters are cleaned **before** the timer has reached its maximum:

- Press and hold the grease filter button for  for approx. 6 seconds, until only the **1** is flashing.

Cleaning and Care

Active charcoal filter

In recirculation mode an active charcoal filter must be used in addition to the grease filters. It is designed to absorb cooking odors.

The active charcoal filter will be replaced in the canopy above the grease filters.

Replacement active charcoal filters can be ordered from Miele.

- To install or replace the charcoal filter, the grease filters must first be removed as described in the previous section.
- Remove the charcoal filter from the packaging.

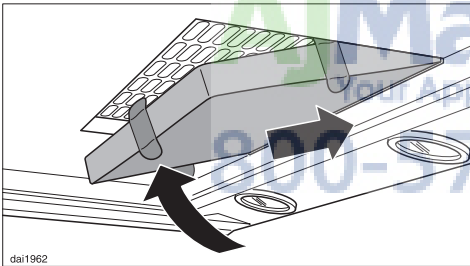

- Slide the charcoal filter into the rear of the filter frame. then raise the front up and push it into the frame.
- Replace the grease filter.

Before using:

- Program the charcoal filter timer, see "Operation / Activating and reprogramming the charcoal filter timer".

Replace the active charcoal filter when the **charcoal filter indicator** lights, at least every 6 months or when they no longer absorb odors efficiently.

Used charcoal filters may be discarded in household trash.

Resetting the charcoal filter timer

After replacing reset the charcoal filter operating hours timer.

- With the fan running, press the charcoal filter button  twice and hold it for approx. 3 seconds, until only the **1** is flashing. The charcoal filter indicator light  will go out.

If the charcoal filter is replaced **before** the timer has reached its maximum:

- Press the charcoal filter button  twice  and hold it for approx. 6 seconds, until only the **1** is flashing.

Changing the light bulbs

⚠ WARNING
TO REDUCE THE RISK OF
FIRE, ELECTRIC SHOCK, OR
INJURY TO PERSONS,
OBSERVE THE FOLLOWING:

Before changing the light bulbs, disconnect the hood from the power supply, see "Important Safety Instructions".

When in use halogen bulbs become extremely hot, and can burn your hands. Do not attempt to change the bulbs until they have had sufficient time to cool.

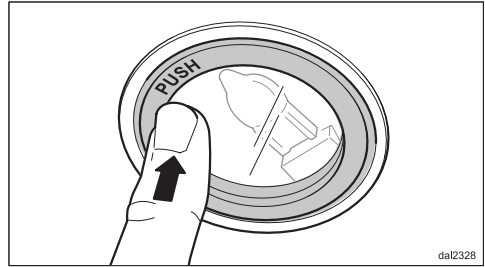

- To change the halogen bulb, first gently press the light cover. The cover will open and can now be flipped down.
- Pull the halogen bulb from its socket.
- Using a cloth or glove, insert the new halogen bulb (type 12 V, 20 W, G4).

Please follow the manufacturer's instructions.

- Flip the light cover back up, making sure it clicks into place.

After Sales Service

Repairs

In the event of a fault which you cannot easily fix yourself, please contact the Miele Technical Service Department.

- When contacting the Technical Service Department, please quote the model and serial number of your appliance.

These are shown on the data plate which is visible when the grease filters are removed.

MieleCare

(USA only)

MieleCare, our Extended Service Contract program, gives you the assurance of knowing that your appliance investment is covered by 5 years of worry free ownership.

MieleCare is the only Extended Service Contract in the industry that guarantees repairs by a Miele Authorized Service Provider using genuine Miele parts. Only genuine Miele parts installed by factory trained professionals can guarantee the safety, reliability, and longevity of your Miele appliance.

Please note that unless expressly approved in writing by Miele's Service department, Extended Service Contracts offered by other providers for Miele products will not be recognized by Miele. Our goal is to prevent unauthorized (and untrained) service personnel from working on your Miele products, possibly doing further damage to them, you and/or your home.

To learn more about **MieleCare** Extended Service Contracts, please contact your appliance dealer or visit us online at:

<http://mieleusa.com/mielecare>

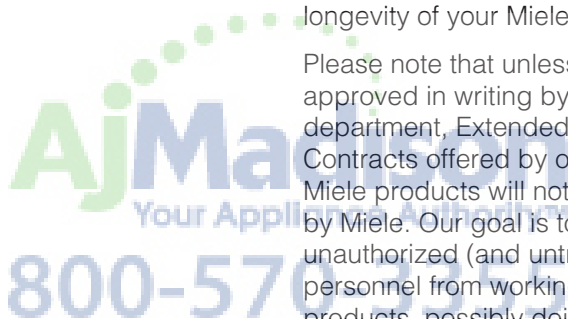

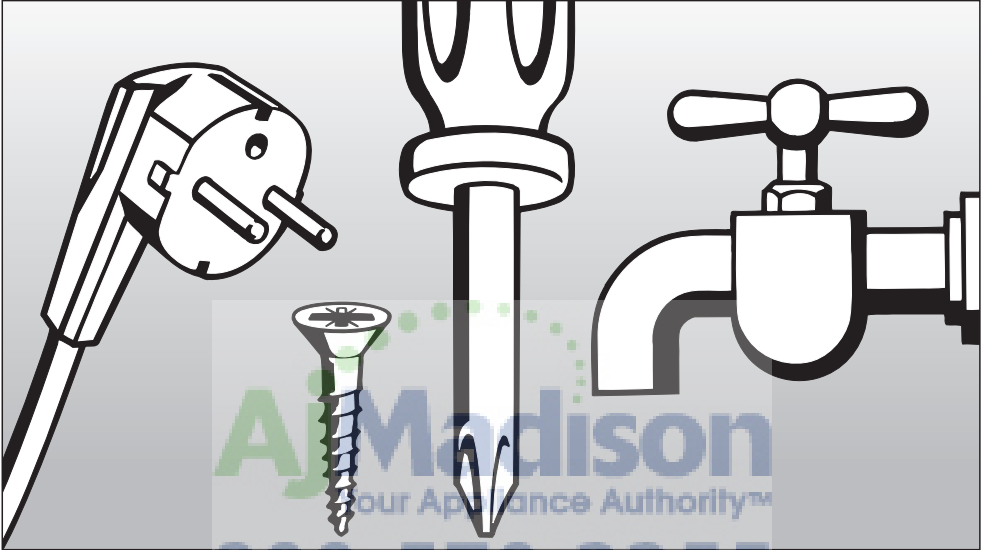

Installation Instructions

Read these instructions and the "Important Safety Instructions" before installing this hood.

The installation steps are described in the enclosed "Installation Diagram".

Leave these instructions with the appliance for the consumer/user.

Information is subject to change. Please refer to our website to obtain the most current product specification, technical & warranty information.



Disposal of packing material

The cardboard box and packing materials protect the appliance during shipping. They have been designed to be biodegradable and recyclable. Please recycle.

 **DANGER**

Ensure that any plastic wrappings, bags, etc., are disposed of safely and kept out of the reach of babies and young children. Danger of suffocation!

Disposal of an old appliance

Old appliances may contain materials that can be recycled. Please contact your local recycling center about the possibility of recycling these materials.

Before discarding an old appliance, disconnect it from the electrical supply and cut off the power cord to prevent it from becoming a hazard.



Appliance dimensions

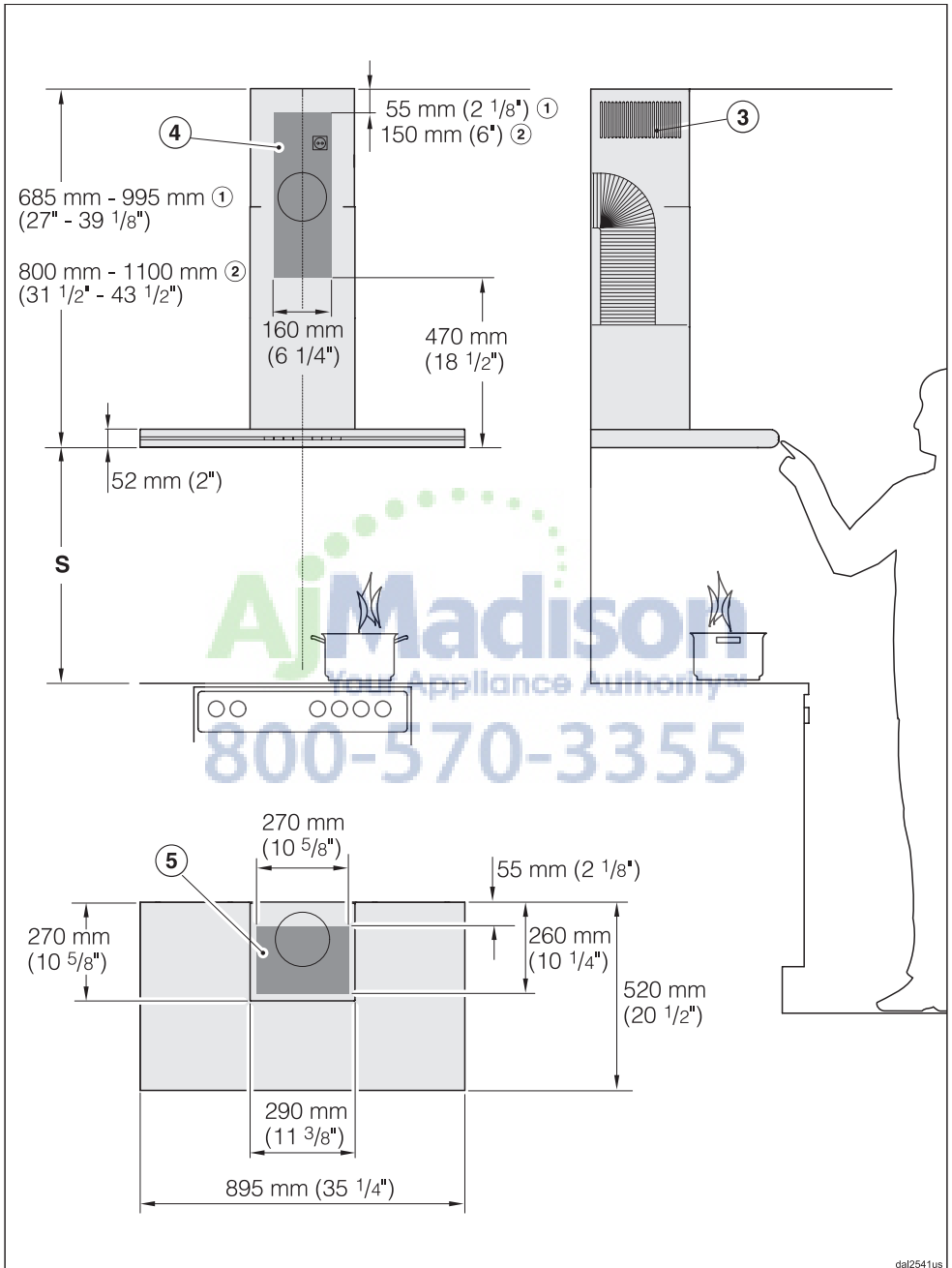

dal2541us

Drawing is not to scale.

- ① Air extraction mode
- ② Recirculation mode
- ③ Recirculation vent positioned at the top (recirculation mode only)
- ④, ⑤ Installation area;
For recirculation mode only ④.
Wall/ceiling area respectively for vent hole and outlet installation.
For recirculation mode only the outlet installation is required.

Connection for air extraction mode

6" (150 mm), with reducing collar

5" (125 mm).



Appliance dimensions

Distance between cooktop and hood (S)

Do not install this exhaust hood over cooktops burning solid fuel.

Provided a larger distance is not given by the manufacturer of the cooktop, follow the minimum safety distances between a cooktop and the bottom of the hood:

	Miele Cooktops	Non-Miele Cooktops
Electric Cooktops	24" (610 mm)	
Electric Barbeques and Fryers	26" (660 mm)	
Multiburner Gas cooktops ≤ 43,000 BTU (12.6 KW) and no burner > 15,000 BTU (4.5 KW)	26" (660 mm)	30" (760 mm)
Single burner (Wok) ≤ 20,500 BTU (6 KW)	26" (660 mm)	30" (760 mm)
All other gas cooktops	30" (760 mm)	

- If several gas surfaces are installed under the hood, the total output must be considered when determining the minimum safety distance.
- Be sure to follow the minimum safety distances given by the gas cooktop manufacturer to easily flammable materials e.g. upper cabinets.
- If local building codes require a greater safety distance, follow their requirement.
- If there is more than one appliance beneath the hood and they have different minimum safety distances always select the greater distance.

See "Important Safety Instructions" for further information.

- To ensure free access to work under the ventilation hood, a distance of a minimum of 26" (660 mm) above the electric cooktop is also recommended.
- Take the user's body height into consideration when selecting the installation height. Adequate work space at the cooktop and optimal operation of the ventilation system should be ensured.
- However, the greater the distance from the cooktop, the less effectively cooking odors are drawn in.
- If the top of the hood will be mounted flush to the ceiling, regard the possible unit height when selecting the installation height.

Drilling diagram

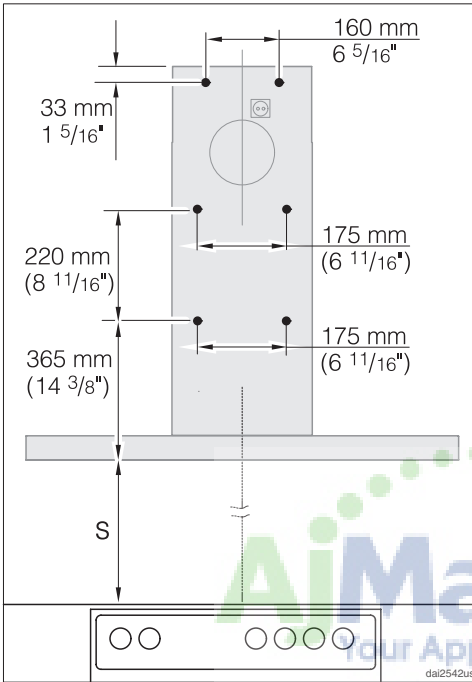

To prepare a backing plate, the spacings for the 5 mm screws need to be drilled as shown.

If the ventilation hood will be mounted directly to the wall, follow the additional instructions given in the included "Installation diagram".

Plywood backing

The majority of the weight of the installed ventilation system will be supported by the lower retaining plate. It must be firmly attached to the stud framing **behind** the drywall. If studs are not available in the required locations, a plywood backing (min. 1/2" (13 mm) thick) spanning at least two studs **must** be installed. Failure to adequately support the weight as stated may result in the ventilation system falling off the wall, causing personal injury and property damage.

(If plywood backing is not needed, proceed to the included "Installation diagram".)

To install a plywood backing

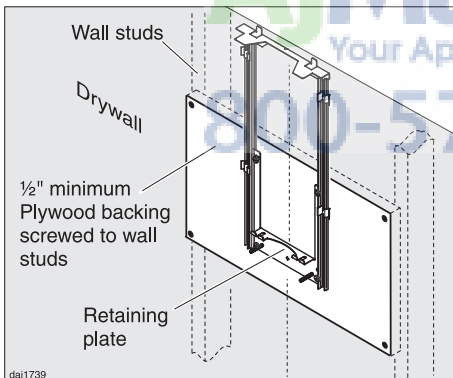

- Find the studs to the left and right of the mounting location by tapping the wall or using a stud finder.
- Mark a vertical cutting line along the center of each stud.

CAUTION

When cutting or drilling into the wall or ceiling, do not damage electrical wiring and other hidden utilities.

- Remove the drywall between the cutting lines and replace it with plywood of a matching thickness (min. 1/2" (13 mm) thick). Tape the joints and refinish the wall.
- Proceed to the enclosed "Installation diagram" to complete the installation.

- Determine and mark the location of the retaining plate for the canopy as outlined on the "Installation diagram".
- Make a cutting line 3" (76 mm) above and 3" (76 mm) below the outline of the retaining plate.

Before installation read the information in the "Dimensions" and "Important Safety Instruction" chapters.

Under certain conditions, there is a danger of poisonous fumes by when the ventilation system and a furnace drawing interior air run at the same time.

Installation instructions

The individual installation steps are described in the included Installation diagram.

Protective film

(stainless steel units)

The casing is covered with a protective film to prevent scratching during transport.

Please peel off the film before installing the casing parts. It can be removed without tools.

Dismantling

If the hood needs to be disassembled, follow the instructions on the "Installation diagram" in the reverse order.

A lever is enclosed for easier removal of the chimney extension.

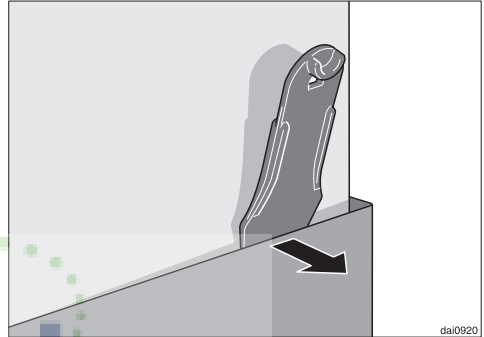

- After removing the two screws from the chimney, slide the lever between the chimney and the chimney extension and gently apply pressure to ease the chimney from its hooks.

Installation

Installation materials

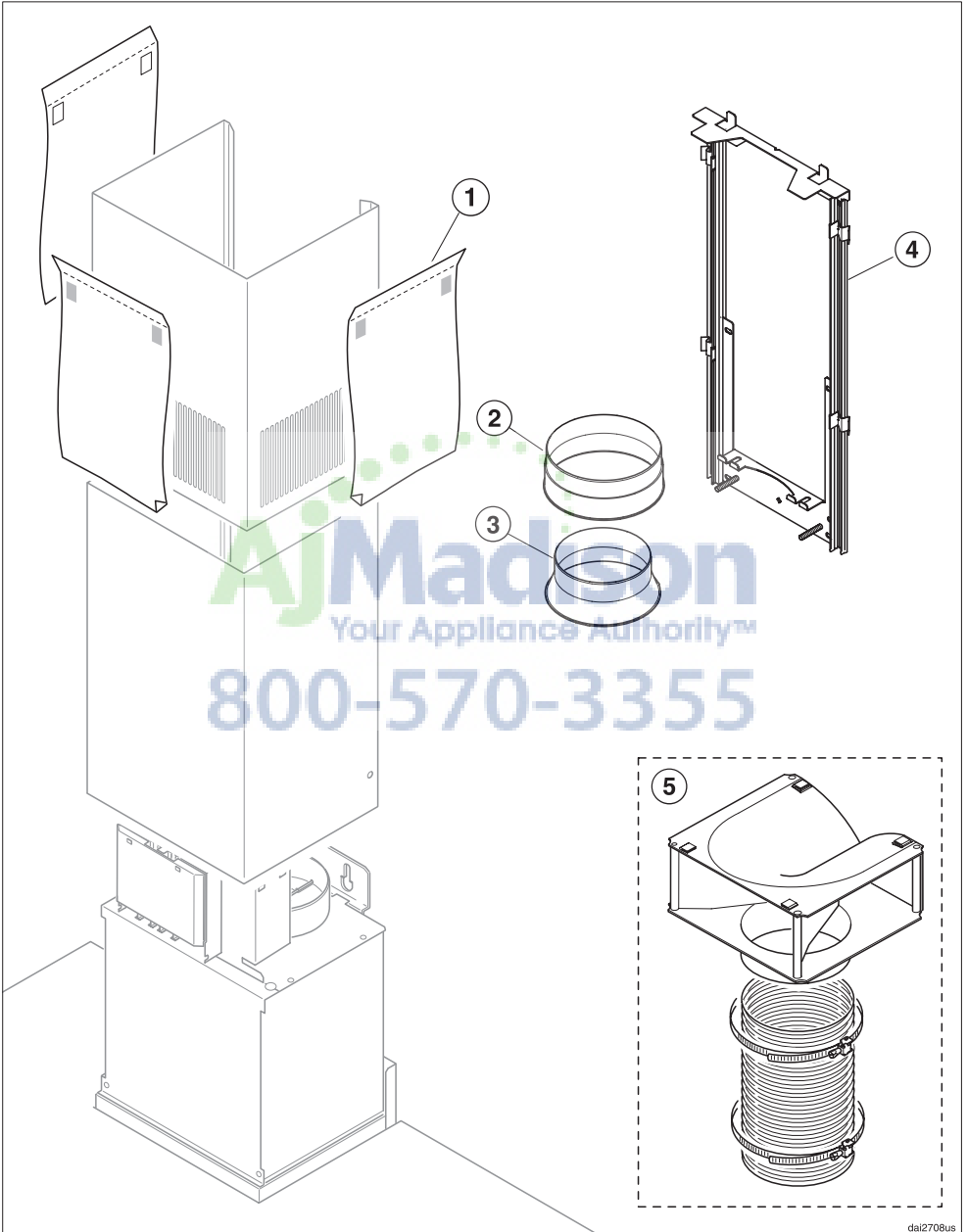

dai270Bus

① **3 protective shields**

to prevent scratches to the chimney during installation.

② **1 vent collar**

for use with 6" (150 mm) exhaust ducting.

② **1 reducing collar**

for use with 5" (125 mm) exhaust ducting.

④ **Telescopic retaining plate** to secure the ventilation hood to the wall.

⑤ **Installation kit for recirculation mode**

contains diverter, hose and hose clips (optional accessory).



6 Screws 5 x 40 mm

(S8 wall anchors included in the packaging are not for use in USA / CDN)

The screws and wall anchors are suitable for solid brick walls. For other wall constructions, use appropriate materials. Ensure that the wall can support the weight.



2 M 6 locking nuts

for securing the motor assembly.



2 Screws 3.9 x 7.5 mm

for securing the chimney.

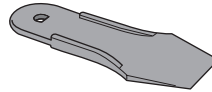

1 Lever

for dismantling the chimney.

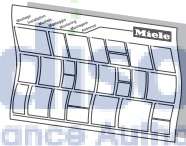

Installation instructions

Air extraction

WARNING

Danger of toxic fumes.

Gas cooking appliances release carbon monoxide that can be harmful or fatal if inhaled.

To reduce the risk of fire and to properly exhaust air, the exhaust gases extracted by the hood should be vented outside of the building only.

Do not vent exhaust air into spaces within walls or ceilings or in attics, crawl spaces or garages.

To reduce the risk of fire, only use metal ductwork.

Please read and follow the **"IMPORTANT SAFETY INSTRUCTIONS"** to reduce the risk of personal injury. Follow all local building codes when installing the hood.

Exhaust ducting and connections

Use smooth or flexible pipework made from approved non-flammable materials for exhaust ducting.

To achieve the most efficient air extraction and quietest noise levels, consider the following:

- The diameter of the ductwork should not be less than 6" (150 mm).
- If flat ducting is used, the cross section must not be smaller than the cross section of the ventilation exhaust.
- The ducting should be as short and straight as possible.
- Use ductwork with a wide radius.
- The exhaust duct must not be bent or compressed.
- Make sure all connections are secure.
- Where the ductwork is horizontal, it must slope away from the hood at least $\frac{1}{8}$ " per foot (1 cm per meter) to prevent condensation dripping into the appliance.
- If the exhaust is ducted through an outside wall, a Telescopic Wall Vent can be used.

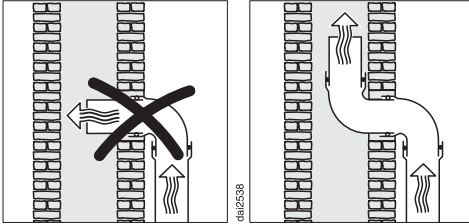

- If the exhaust is ducted into an inactive flue, the air must be expelled parallel to the flow direction of the flue.

Never connect an exhaust hood to an active chimney, dryer vent, flue, or room venting ductwork. Seek professional advice before connecting an exhaust hood vent to an existing, inactive chimney or vent flue.

Important

If the ductwork runs through rooms, ceilings, garages, etc. where temperature variations exist, it may need to be insulated to reduce condensation.

Condensate trap

optional accessory

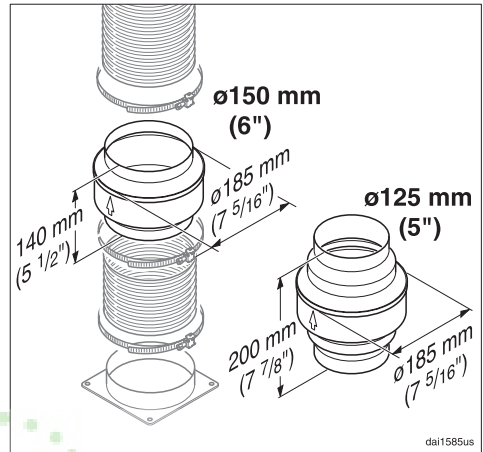

In some cases, a condensate trap may also be required to collect and evaporate any condensate which may occur. This optional accessory is available for ducts 5" (125 mm) and 6" (150 mm) in diameter.

When installing a condensate trap, ensure that it is positioned vertically and if possible directly above the exhaust outlet.

Electrical connection

⚠ WARNING **TO REDUCE THE RISK OF** **FIRE, ELECTRIC SHOCK, OR** **INJURY TO PERSONS,** **OBSERVE THE FOLLOWING:**

All electrical work should be performed by a qualified electrician in strict accordance with national regulations (for USA: ANSI-NFPA 70) and local safety regulations. Installation, repairs and other work by unqualified persons could be dangerous. Ensure that power to the appliance is off while installation or repair work is performed.

- Verify that the voltage, load and circuit rating information found on the data plate (located behind the grease filters), match the household electrical supply before installing the hood.
- Use only with ventilation hood cord-connection kits that have been investigated and found acceptable for use with this model hood.

If there is any question concerning the electrical connection of this appliance to your power supply, please consult a licensed electrician or contact Miele's Technical Service Department.

USA 1-800-999-1360
CDN 1-800-565-6435

WARNING: **THIS APPLIANCE MUST BE** **GROUNDED**

Grounding Instructions

This appliance must be grounded. In the event of an electrical short circuit, grounding reduces the risk of electric shock by providing a path of least resistance. This appliance is equipped with a cord having a grounding wire with a grounding plug. The plug must be plugged into an outlet that is properly installed and grounded.

WARNING - Improper grounding can result in a risk of electric shock.

If there is any doubt, have the electrical system of the house checked by a qualified electrician.

Do not use an extension cord. If the power supply cord is too short, have a qualified electrician install an outlet near the appliance.

Important

The hood comes equipped with a 4 ft (1.2 m) power cord with a NEMA 5-15 molded plug for connection to a 120 V, 60 Hz, 15 A power outlet.

Total connected load. 420 W
– fan motor. 350 W
– direct lighting 3 x 20 W
– lighting on glass edges 10 W
Power supply voltage 120 V
Frequency 60 Hz
Circuit rating. 15 A
Length of power cord 4'11" (1.5 m)
Weight 62 lbs (28 kg)



**Please have the model and serial number
of your appliance available before
contacting Technical Service.**



**U.S.A.
Miele, Inc.**

National Headquarters

9 Independence Way
Princeton, NJ 08540
Phone: 800-843-7231
609-419-9898
Fax: 609-419-4298
www.mieleusa.com

**Technical Service & Support
Nationwide**

Phone: 800-999-1360
Fax: 888-586-8056

TechnicalService@mieleusa.com

**Canada
Miele Limited**

Headquarters and Showroom

161 Four Valley Drive
Vaughan, ON L4K 4V8
Phone: 800-643-5381
905-660-9936
Fax: 905-532-2290
www.miele.ca
professional@miele.ca
(commercial enquiries)

MieleCare National Service

Phone: 800-565-6435
905-532-2272
Fax: 905-532-2292
customercare@miele.ca
(general and technical enquiries)

Germany

Miele & Cie. KG
Carl-Miele-Straße 29
33332 Gütersloh

