

Operating and Installation Instructions

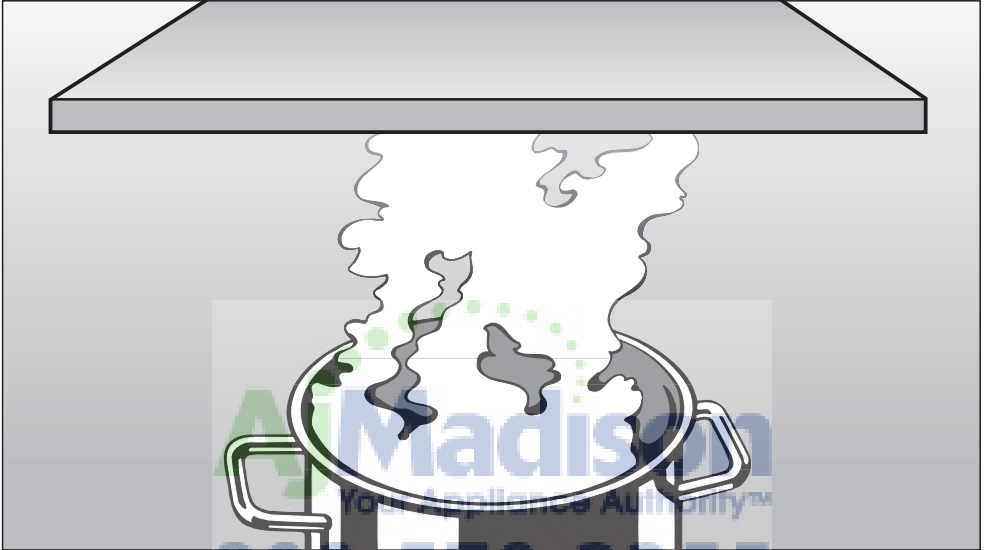

Ventilation System DA 6290 D

To prevent accidents
and appliance damage,
read these instructions

before

installation or use.

en - US, CA

M.-Nr. 07 852 220

Contents

IMPORTANT SAFETY INSTRUCTIONS	3
Functional description	7
Guide to the Ventilation System	8
Operation	10
Turning on the fan ①	10
Selecting the power level - / +	10
Intensive setting "IS"	10
Delayed Shut Down 5 ⌚ 15	11
Overhead lighting ☉	11
Glass edge lighting ☾	12
Changing the color of the glass edge lighting ☾	12
Filter timer button ⌚	13
Cleaning and Care	14
Cleaning the casing	14
Grease filter	15
Resetting the grease filter timer	16
Changing the light bulbs	17
After Sales Service	18
Installation instructions	19
Caring for the environment	20
Appliance dimensions	21
Structural support	23
Installation	24
Installation instructions	24
Installation material	24
Air extraction	25
Condensate trap	26
Electrical connection	27
Technical Data	28



IMPORTANT SAFETY INSTRUCTIONS

READ AND SAVE THESE INSTRUCTIONS

Keep these instructions in a safe place and pass them on to any future user.

Read these instructions carefully before installing or using the Ventilation System.

► This appliance is intended for residential use only. Use the appliance only for its intended purpose.

► This appliance complies with current safety requirements. Improper use of the appliance can lead to personal injury and material damage.

⚠ CAUTION
For General Ventilating Use Only. Do Not Use To Exhaust Hazardous Or Explosive Materials And Vapors.

► This appliance is designed to vent cooking smoke and odors only.

► This appliance is suitable for installation above gas or electric cooking surfaces.

► This appliance is not designed for maritime use or for use in mobile installations such as recreational vehicles or aircraft. However, under certain conditions installation in these applications may be possible. Please contact your Miele dealer or the Miele Technical Service Department with specific requirements.

⚠ WARNING
TO REDUCE THE RISK OF FIRE, ELECTRIC SHOCK, OR INJURY TO PERSONS, OBSERVE THE FOLLOWING:

► a) Use this appliance only in the manner intended by the manufacturer. If you have questions, contact Miele.

► b) Before servicing or cleaning the appliance, switch power off at the service panel and lock the service disconnecting means to prevent power from being switched on accidentally. If the service disconnecting means cannot be locked, securely fasten a prominent warning device, such as a tag, to the service panel.

► c) Be certain your appliance is properly installed and grounded by a qualified technician. To guarantee the electrical safety of this appliance, continuity must exist between the appliance and an effective grounding system. It is imperative that this basic safety requirement be met. If there is any doubt, have the electrical system of the house checked by a qualified electrician.

IMPORTANT SAFETY INSTRUCTIONS

▶ d) Before connecting the appliance to the power supply make sure that the voltage and frequency listed on the data plate correspond with the household electrical supply. This data must correspond to prevent appliance damage. If in doubt consult a qualified electrician.

▶ e) Installation work and repairs should only be performed by a qualified technician in accordance with all applicable codes and standards. Repairs and other work by unqualified persons could be dangerous.

▶ f) Only open the housing as described in the enclosed "Installation diagram" and in the "Cleaning and care" section of this manual. Under no circumstances should any other parts of the housing be opened. Tampering with electrical connections or components and mechanical parts is highly dangerous to the user and can cause operation faults.

▶ g) Before discarding an old appliance, disconnect it from the power supply and remove the power cord to prevent hazards.

Use

WARNING **TO REDUCE THE RISK OF A COOKTOP GREASE FIRE:**

▶ a) Never leave surface units unattended at high settings. Boilovers cause smoking and greasy spillovers may ignite. Heat oils slowly on low or medium settings.

▶ b) Always turn the hood on when cooking at a high heat.

▶ c) Clean the ventilation hood frequently. Grease should not be allowed to accumulate on the fan or filter.

▶ d) Use the proper pan size. Always use cookware appropriate for the size of the cooking area.

▶ e) Do not flambé or grill with an open flame beneath the hood. Flames could be drawn up into the hood by the suction and the grease filters may catch fire.

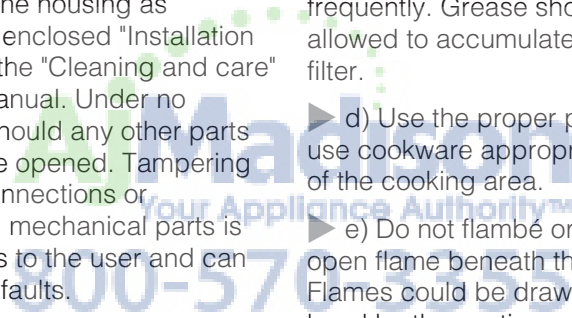

IMPORTANT SAFETY INSTRUCTIONS

⚠ WARNING
TO REDUCE THE RISK OF INJURY TO PERSONS IN THE EVENT OF A COOKTOP GREASE FIRE, OBSERVE THE FOLLOWING*:

▶ a) **SMOTHER FLAMES** with a close fitting lid, cookie sheet, or metal tray then turn off the burner.

BE CAREFUL TO PREVENT BURNS. If the flames do not go out immediately, **EVACUATE AND CALL THE FIRE DEPARTMENT.**

▶ b) **NEVER PICK UP A FLAMING PAN** - You may be burned.

▶ c) **DO NOT USE WATER**, including wet dishcloths or towels - a violent steam explosion will result.

▶ d) Use a fire extinguisher **ONLY** if:

- 1) You have a class ABC extinguisher, and you know how to operate it.
- 2) The fire is small and contained in the area where it started.
- 3) The fire department is being called.
- 4) You can fight the fire with your back to an exit.

▶ Do not allow children to play with or operate the appliance or its controls. Supervise its use by the elderly or infirm.

▶ Always turn on the hood when using the cooktop to prevent damage from condensation.

▶ Never operate gas burners without cookware. Turn the burner off when not in use. Adjust the burner so that the flames do not extend beneath the cookware. Do not overheat the cookware, e.g. when using a wok. The hood can be damaged due to excessive heat from the burners and the cookware.

▶ Do not use the hood without the grease filters in place.

▶ Do not use a steam cleaner to clean the hood. Steam could penetrate electrical components and cause a short circuit.

* Based on "Kitchen Firesafety Tips" published by NAFTA

IMPORTANT SAFETY INSTRUCTIONS

Installation

⚠ WARNING
TO REDUCE THE RISK OF
FIRE, ELECTRIC SHOCK, OR
INJURY TO PERSONS,
OBSERVE THE FOLLOWING:

- ▶ a) Installation work and electrical wiring must be done by qualified person(s) in accordance with all applicable codes and standards, including fire-rated construction.
- ▶ b) Sufficient air is needed for combustion and exhausting of gases through the flue (chimney of fuel burning equipment to prevent back drafting. Follow the heating equipment manufacturer's guideline and safety standards such as those published by the National Fire Protection Association (NFPA) and the American Society for Heating, Refrigeration and Air Conditioning Engineers (ASHRAE), and the local code authorities.
- ▶ c) When cutting or drilling into the wall or ceiling, do not damage electrical wiring and other hidden utilities.
- ▶ d) Ducted hoods must always be vented to the outdoors.
- ▶ e) Do not use this hood with any solid-state speed control device.
- ▶ f) Do not use an extension cord to connect the appliance to electricity. Extension cords do not guarantee the required safety of the appliance, (e.g. danger of overheating).

▶ g) Do not install this hood over cooktops that burn solid fuel.

▶ h) Provided a larger distance is not given by the manufacturer of the cooktop, follow the minimum safety distances between a cooktop and the bottom of the hood given in the "Appliance dimensions" section of this manual.

If local building codes require a greater safety distance, follow their requirement.

If there is more than one appliance beneath the hood and they have different minimum safety distances always select the greater distance.

▶ i) Never connect an exhaust hood to an active chimney, dryer vent, vent flue, or room ventilating ductwork.

▶ j) Seek professional advice before connecting an exhaust hood vent to an existing, inactive chimney or vent flue.

▶ k) Any fittings, sealant, or materials used to install the ductwork must be made of approved non-flammable materials.

⚠ WARNING
TO REDUCE THE RISK OF
FIRE USE ONLY METAL
DUCTWORK.

Air extraction

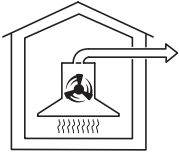

The air is drawn in and cleaned by the grease filters and directed outside.

The hood comes equipped with a **non-return flap**. This flap automatically closes when the hood is turned off so that no exchange of outside air and room air can occur. When the hood is turned on, the air pressure of the exhaust fan automatically opens the flap blowing the inside air and cooking odors outside.

AjMadison
Your Appliance Authority™
800-570-3355

Guide to the Ventilation System

① Chimney extension

② Chimney

③ Canopy

④ Control panel

⑤ Glass edge lighting

⑥ Overhead lighting

⑦ Grease filter

⑧ On/Off button for the glass edge lighting

⑨ On/Off button for the overhead lighting

This button turns the light on and off and also dims the light.

⑩ On/Off button

⑪ Fan power selection

⑫ Delayed shut down

This button activates the Delayed Shut Down feature. The fan can be set to turn off automatically after either 5 or 15 minutes.

⑬ Filter button

The indicator  of the grease filter button lights when the grease filters need to be cleaned.

This button can be used at any time after cleaning to reset the grease filter timer (see "Cleaning and Care").

Additionally, you can check or change the number of hours.

The indicator  has no function with this model ventilation hood.

⑭ Color change

This button is used to change the color of the glass edge lighting.

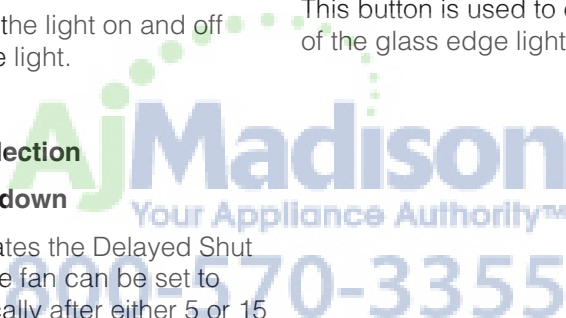

Operation

Turning on the fan ①

- Press the On/Off button ①.

The fan turns on to Level **2** and the ① symbol and the **2** of the power level indicator lights up.

Selecting the power level – / +

- Press the "–" symbol to select a lower power level or the "+" symbol for a higher power level.

Depending on the amount of cooking odors, levels **1** to **3** are usually sufficient for normal cooking.



Intensive setting "IS"

To remove strong aromas or odors, for example when frying, select power level **IS** temporarily.

Automatically switching back the intensive power level

The intensive level can be programmed to automatically switch back to level **3** after 10 minutes.

- To do so, turn the fan and the overhead lighting off.
- Press and hold the "Delayed shut down" button **5**  **15** for approx. 10 seconds until power level indicator **1** lights up.
- Then press the following buttons one after another –

- light ,
- the "–" button, and
- the light button  again.

If the indicators **1** and **IS** flash, the automatic switch back is not activated.

- To activate the automatic switch back, press the "+" button. The power level indicators **1** and **IS** light continuously. To deactivate, press the "–" button.
- To save the setting, press the "Delayed shut down" button **5**  **15**.

If the procedure is not stored within 4 minutes, the hood will automatically default to the "old" data.

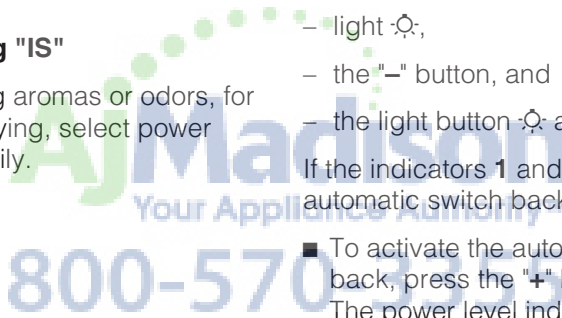



Delayed Shut Down 5 15



For both air extraction and recirculation, it is recommended that run the fan for several minutes after cooking is completed.

This helps clear the kitchen air of any remaining vapors and odors.

The Delayed Shut Down feature can be selected to turn the fan off automatically after a preselected length of time.

■ After cooking, and with the fan on, press the Delayed Shut Down button **5  15** –

- once: the fan automatically switches off after 5 minutes (**5  15** lights up).
- twice: the fan automatically switches off after 15 minutes (** 15** lights up).

If you press the Delayed Shut Down button **5  15** again, the fan will not turn off automatically (**5  15** goes out).

Turning off the fan

■ Press the On/Off button to turn the fan off .

The  indicator goes out.

Overhead lighting

Turning the overhead lighting on

The overhead lighting can be turned on and off independently of the fan.

■ Press the light button  briefly to turn on the lighting.

The  light button indicator illuminates.

The overhead lighting comes on at maximum brightness.

Dimming the overhead lighting

The brightness of the lighting can be adjusted.

■ While the lighting is turned on, press and hold the light button . The lighting will dim until the button is released.

■ If the button  is pressed and held down again, the lighting will brighten until the button is released.

If the  button is pressed continuously, the lighting will cycle between light and dark.

Turning the overhead lighting off

■ Briefly press the light button  to turn off the lighting.

The  indicator goes out.

Operation



Glass edge lighting

- Press the button for the glass edge lighting  to have the glass edge lit from behind. It can be turned on and off independently of the fan and overhead lighting.

Changing the color of the glass edge lighting

The color of the glass edge lighting can be changed as desired.

White is the preset color.

- Turn on the glass edge lighting .
- Six factory-set colors can be called up by pressing the color change button  repeatedly:
 - ① White
 - ② Green
 - ③ Red
 - ④ Blue
 - ⑤ Rapid color sequence
The light color changes continuously. All colors are cycled through at an interval of one minute. The button indicator flashes rapidly at the start.
 - ⑥ Slow color sequence
Operates the same above, but the interval is 15 minutes. The button indicator flashes slowly at the start.

A selected light color can be saved.

To select the color:

- Select the rapid or slow color sequence (color setting ⑤ or ⑥).

The continuous color changes start.

- When the desired color is reached, press and hold the color change button  until the glass edge lighting flashes three times.

This light color is now saved as an additional color setting ⑦.

- It can be selected at any time until a new color is saved in the same way.
- To turn it off, press the button for the glass edge lighting . The lighting turns off after a short delay.

The next time you turn it on, the last active color setting ① to ⑦ is selected.

Automatic Safety Shut-Off

The fan will turn automatically off 10 hours of use. The lighting however will remain on.

- Press the On/Off button ① to turn the fan back on again.

Filter timer button

A timer records the hours of fan operation.

The operating hours timer will signal that the grease filter needs to be cleaned by lighting up the grease filter indicator .

See the "Cleaning and care " chapter for information on cleaning filters and resetting the timer.

Reprogramming the grease filter timer

The timer may be set to suit your cooking habits.

- If you often roast and fry foods, choose a shorter operating time.
- If you tend to cook fat-free, choose a longer operating time.
- If you cook only occasionally, it is better to choose a shorter operating time. This is because accumulated grease will harden over time, making cleaning difficult.

The factory setting for the grease filter timer is 30 hours. You can adjust the time to 20, 30, 40 or 50 hours.

■ Press the On/Off button  to turn off the fan.

■ Press the Delayed Shut Down **5**  **15** and filter button  at the same time.

The indicator for the grease filter  timer and one of the power level indicators will flash.

The **1** to **IS** indicators show the programmed time:

Indicator **1** = 20 hours

Indicator **2** = 30 hours

Indicator **3** = 40 hours

Indicator **IS** = 50 hours

■ Press the "-" symbol to select a shorter operating time or the "+" symbol for a longer one.

■ Store the selection by pressing the filter button .

All the lights will go out.

If the procedure is not stored within 4 minutes, the hood will automatically default to the "old" data.

Cleaning and Care

⚠ WARNING
TO REDUCE THE RISK OF
FIRE, ELECTRIC SHOCK, OR
INJURY TO PERSONS,
OBSERVE THE FOLLOWING:

Before cleaning or servicing the hood, disconnect it from the power supply, see "Important Safety Instructions".

Cleaning the casing

Never use abrasive cleaners, scouring pads, steel wool or caustic (oven) cleaners on the hood. They **will** damage the surface.

- All external surfaces and controls can be cleaned with a mild solution of warm water and liquid dish soap applied with a soft sponge.

Do not use too much water when cleaning the controls. Water could penetrate the electronics and cause damage.

- Wipe dry using a soft cloth.

Avoid:

- cleaning agents containing soda, acids or chlorides,
- abrasive cleaning agents e.g. powder or cream cleansers,
- abrasive sponges, e.g. pot scourers or sponges which have been previously used with abrasive cleaning agents.

These will damage the surface.

The following instructions for cleaning "Stainless steel" surfaces and "Stainless steel colored controls" should be followed **in addition to** the general "Cleaning the casing" instructions.

Special instructions for appliances with stainless steel surfaces

(not applicable to the controls)

Stainless steel surfaces can be cleaned using a non-abrasive stainless steel cleaner.

To help prevent resoiling, a conditioner for stainless steel can be applied.

Special instructions for appliances with colored casings

(Special order)

It is very difficult to clean this type of surface without causing minor marks to the surface material. This can become particularly noticeable with darker colors and if there is halogen lighting in the kitchen.

Stainless steel colored controls

These controls may become discolored or damaged if not cleaned regularly.
Do not use a stainless steel cleaner on these controls.

Glass edge

- The glass edge can be cleaned using a household glass cleaner.

Avoid using sharp metal scrapers and oven spray.

Grease filter

The reusable metal grease filters in the hood remove solid particles from the vented kitchen air (grease, dust, etc) and prevent soiling of the ventilation system.

The grease filters should be cleaned every 3 - 4 weeks or when the grease filter indicator lights.

 A dirty filter is a fire hazard!

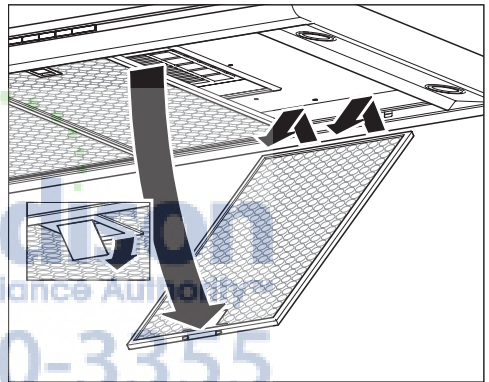

- To remove the grease filter pull the locking clip forward, lower the filter down 45°, unhook it at the rear, and take it out.

Support the grease filter so that it does not fall and damage the cooktop.

AjMadison
Your Appliance Authority
800-570-3355

Cleaning and Care

Cleaning the grease filters

- **By hand:** use a scrub brush with a solution of warm water and mild dish soap.

Do not use the pure detergent, aggressive all purpose cleaners, oven sprays, abrasive cleaning agents or limescale removers. They could damage the filter.

- **In a dishwasher:** place the filter vertically in the lower basket, making sure that the spray arm is not blocked.

Use a wash program with a max. temperature of 150°F (65°C). In a Miele dishwasher use the "Normal" program.

Use the recommended amount of dishwasher detergent. Overuse could destroy the filter.

Depending on the detergent, cleaning the grease filters in a dishwasher may cause permanent discoloration of the filter surface. Filter performance will not be affected by this discoloration.

- After cleaning, place the filters on a towel to air dry.

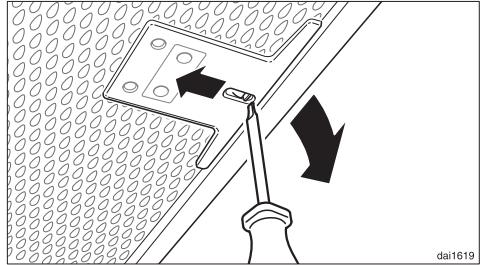

- While the filters are removed, clean any dirt or grease from the filter casing.
- When putting the grease filters back make sure that the locking clips are visibly facing the cooking surface



- If the filters are incorrectly installed, insert a small screwdriver into the slit along its edge to disengage it from the casing.

Resetting the grease filter timer

After cleaning reset the grease filter operating hours timer.

- With the fan running, press and hold the grease filter button  for approx. 3 seconds, until only the **1** is flashing. The indicator light  will go out.

If the grease filters are cleaned **before** the timer has reached its maximum:

Press and hold the grease filter button  for about 6 seconds, until only the **1** is flashing

Changing the light bulbs

⚠ WARNING
TO REDUCE THE RISK OF
FIRE, ELECTRIC SHOCK, OR
INJURY TO PERSONS,
OBSERVE THE FOLLOWING:

Before changing the light bulbs, disconnect the hood from the power supply, see "Important Safety Instructions".

When in use halogen bulbs become extremely hot, and can burn your hands. Do not attempt to change the bulbs until they have had sufficient time to cool.

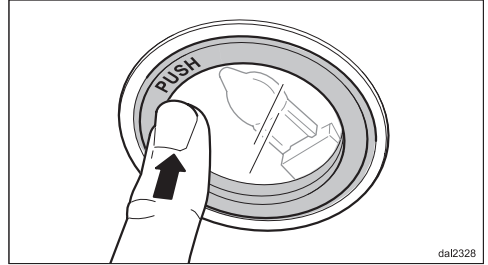

- To change the halogen bulb, first gently press the light cover. The cover will open and can now be flipped down.
- Pull the halogen bulb from its socket.
- Using a cloth or glove, insert the new halogen bulb (type 12 V, 20 W, G4).

Please follow the manufacturer's instructions.

- Flip the light cover back up, making sure it clicks into place.

After Sales Service

Repairs

In the event of a fault which you cannot easily fix yourself, please contact the Miele Technical Service Department.

- When contacting the Technical Service Department, please quote the model and serial number of your appliance.

These are shown on the data plate which is visible when the grease filters are removed.

MieleCare

(USA only)

MieleCare, our Extended Service Contract program, gives you the assurance of knowing that your appliance investment is covered by 5 years of worry free ownership.

MieleCare is the only Extended Service Contract in the industry that guarantees repairs by a Miele Authorized Service Provider using genuine Miele parts. Only genuine Miele parts installed by factory trained professionals can guarantee the safety, reliability, and longevity of your Miele appliance.

Please note that unless expressly approved in writing by Miele's Service department, Extended Service Contracts offered by other providers for Miele products will not be recognized by Miele. Our goal is to prevent unauthorized (and untrained) service personnel from working on your Miele products, possibly doing further damage to them, you and/or your home.

To learn more about **MieleCare** Extended Service Contracts, please contact your appliance dealer or visit us online at:

<http://mieleusa.com/mielecare>

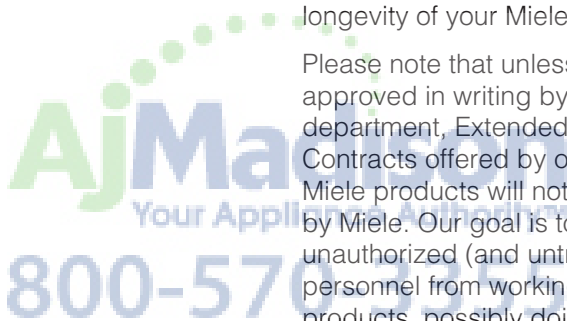

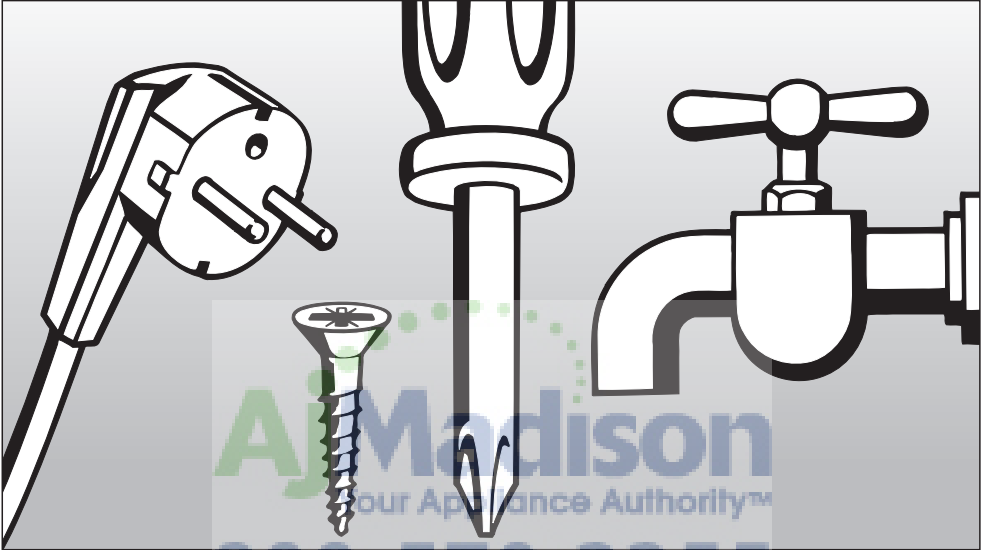

Installation Instructions

Read these instructions and the "Important Safety Instructions" before installing this ventilation system.

The installation steps are described in the enclosed "Installation Diagram".

Leave these instructions with the appliance for the consumer/user.

Information is subject to change. Please refer to our website to obtain the most current product specification, technical & warranty information.

Caring for the environment

Disposal of packing material

The cardboard box and packing materials protect the appliance during shipping. They have been designed to be biodegradable and recyclable. Please recycle.

 **DANGER**

Ensure that any plastic wrappings, bags, etc., are disposed of safely and kept out of the reach of babies and young children. Danger of suffocation!

Disposal of an old appliance

Old appliances may contain materials that can be recycled. Please contact your local recycling center about the possibility of recycling these materials.

Before discarding an old appliance, disconnect it from the electrical supply and cut off the power cord to prevent it from becoming a hazard.



Appliance dimensions

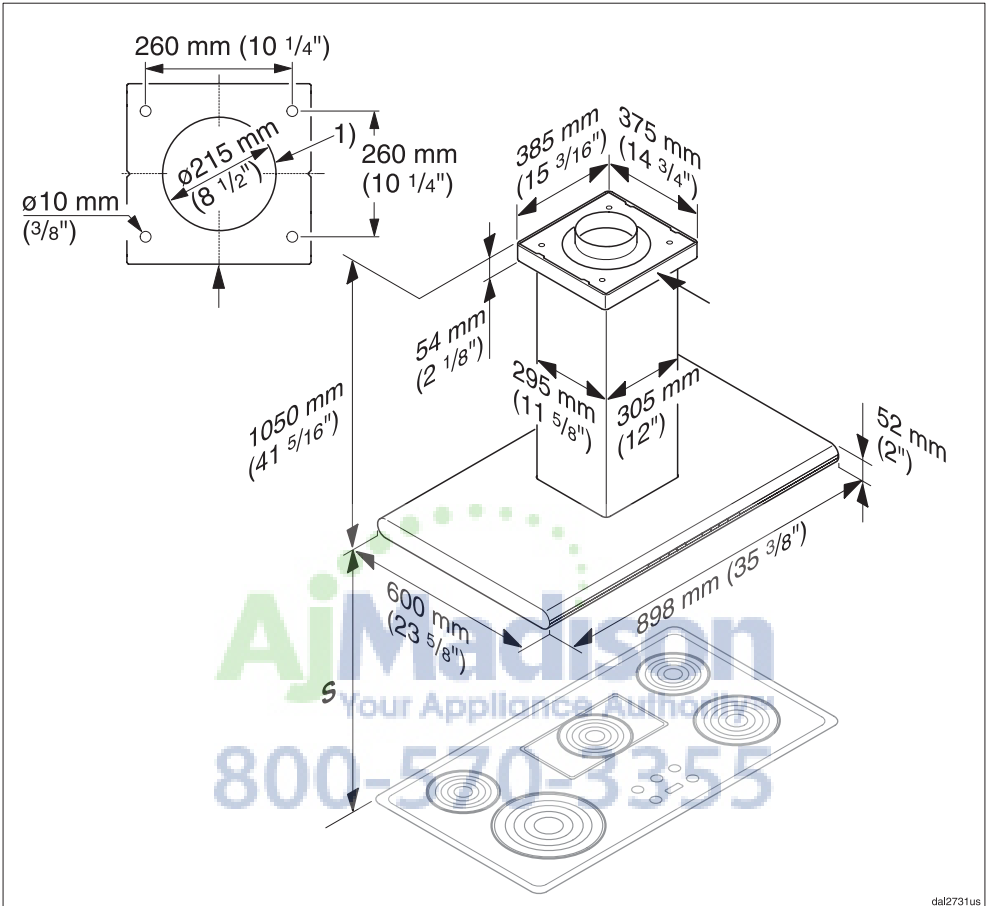

dal2731us

1) Opening for exhaust duct and power cord

Exhaust connection \varnothing 6" (150 mm)

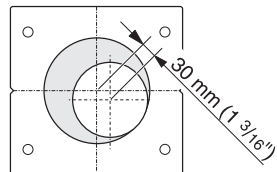

The exhaust connection in the ceiling plate is not secured in the center. This makes installation possible if the connection in the ceiling is not centered above the cooktop. A max. variance of 1 3/16" (30 mm) in any direction is possible.

Appliance dimensions

Distance between cooktop and hood (S)

Do not install this exhaust hood over cooktops burning solid fuel.

Provided a larger distance is not given by the manufacturer of the cooktop, follow the minimum safety distances between a cooktop and the bottom of the hood:

	Miele Cooktops	Non-Miele Cooktops
Electric Cooktops	24" (610 mm)	
Electric Barbeques and Fryers	26" (660 mm)	
Multiburner Gas cooktops ≤ 43,000 BTU (12.6 KW) and no burner > 15,000 BTU (4.5 KW)	26" (660 mm)	30" (760 mm)
Single burner (Wok) ≤ 20,500 BTU (6 KW)	26" (660 mm)	30" (760 mm)
All other gas cooktops	30" (760 mm)	

- If several gas surfaces are installed under the hood, the total output must be considered when determining the minimum safety distance.
- Be sure to follow the minimum safety distances given by the gas cooktop manufacturer to easily flammable materials e.g. upper cabinets.
- If local building codes require a greater safety distance, follow their requirement.
- If there is more than one appliance beneath the hood and they have different minimum safety distances always select the greater distance.

See "Important Safety Instructions" for further information. Also see the "Important Safety Instructions" section.

- To ensure free access to work under the ventilation hood, a distance of a minimum of 26" (660 mm) above the electric cooktop is also recommended.

Structural support

The ceiling mounting plate will support the weight of the hood. This ceiling plate must be attached to rigid structural framing that is supported in its entirety by the ceiling joists, or to the ceiling joists directly. Do not attach the plate directly to the ceiling with anchors, toggle bolts, etc.

CAUTION

When cutting or drilling into the wall or ceiling, do not damage electrical wiring and other hidden utilities.

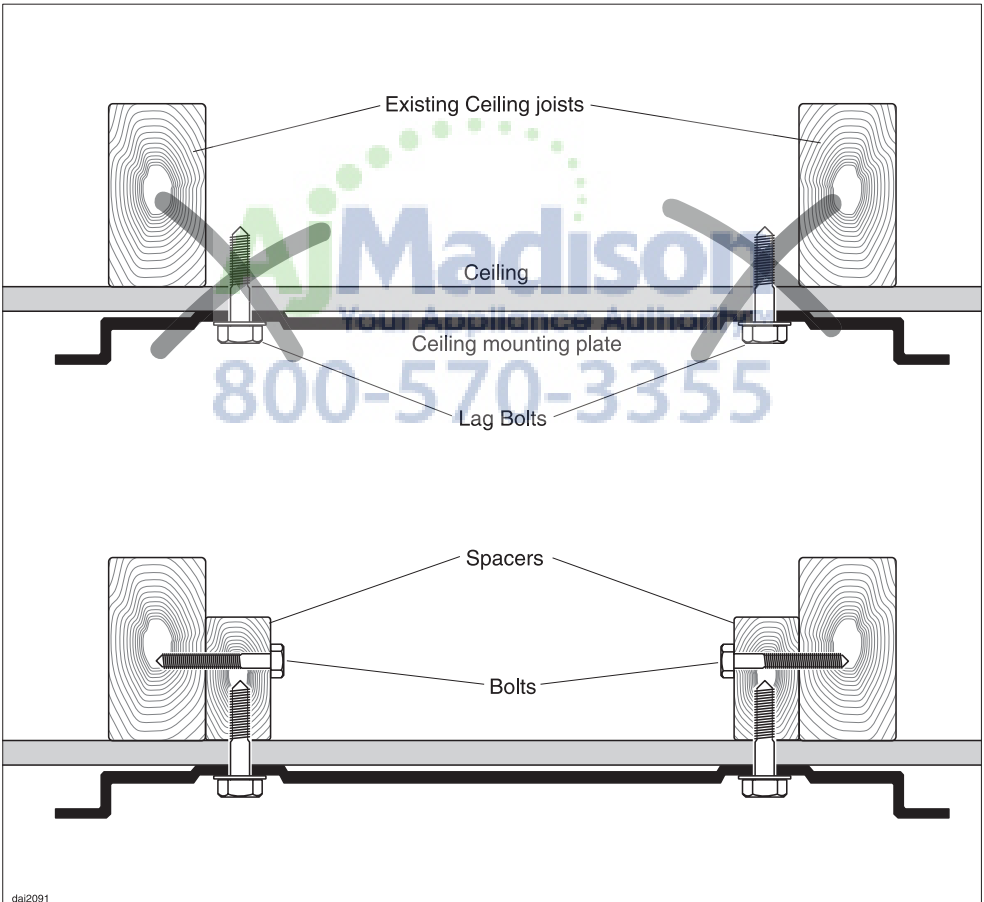

dai2091

Installation

Before installation read the information in the "Appliance Dimensions" and "Important Safety Instruction" chapters. Under certain conditions, there is a danger of poisonous fumes by when the ventilation system and a furnace drawing interior air run at the same time.



4 levelling plates for correcting an uneven ceiling.

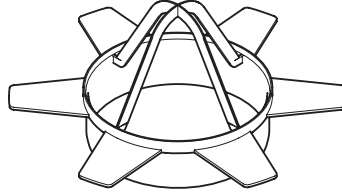

Installation instructions

The individual installation steps are described in the included Installation diagram.

1 vent collar for allowing a variable position for the vent hole in the ceiling.

Installation materials



4 screws 8 x 60 mm with
4 washers and
4 wall anchors S 10 for securing the ceiling plate to the ceiling



1 hose clamp for attaching the exhaust duct to the vent collar.

The screws and anchors are suitable for mounting on concrete ceilings. For other types of ceiling materials, use appropriate materials. Ensure that the ceiling can support the load.



2 screws M4 x 8 mm for securing the chimney.

WARNING

Danger of toxic fumes.

Gas cooking appliances release carbon monoxide that can be harmful or fatal if inhaled.

To reduce the risk of fire and to properly exhaust air, the exhaust gases extracted by the hood should be vented outside of the building only.

Do not vent exhaust air into spaces within walls or ceilings or in attics, crawl spaces or garages.

To reduce the risk of fire, only use metal ductwork.

Please read and follow the **"IMPORTANT SAFETY INSTRUCTIONS"** to reduce the risk of personal injury. Follow all local building codes when installing the hood.

Exhaust ducting and connections

Use smooth or flexible pipework made from approved non-flammable materials for exhaust ducting.

To achieve the most efficient air extraction and quietest noise levels, consider the following:

- The diameter of the ductwork should not be less than 6" (150 mm).
- If flat ducting is used, the cross section must not be smaller than the cross section of the vent collar.
- The ducting should be as short and straight as possible.
- Use ductwork with a large radius.
- The exhaust ducting must not be bent or compressed.
- Make sure all connections are secure.
- Where the ductwork is horizontal, it must slope away from the hood at least 1/8" per foot (1 cm per meter). This is to prevent condensation dripping into the ventilation hood.
- If the exhaust is ducted through an outside wall, a telescopic wall vent or a roof duct can be used.

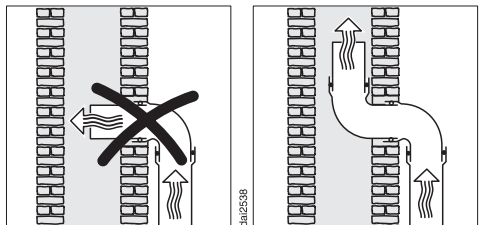

- If the exhaust is ducted into an inactive flue, the air must be expelled parallel to the flow direction of the flue.

Air extraction

Important!

If the ductwork runs through cool rooms, ceilings, etc. large temperature variations may occur in places. This can lead to moisture and condensation. It will be necessary to insulate the exhaust ducting.

Condensate trap

(optional accessory)

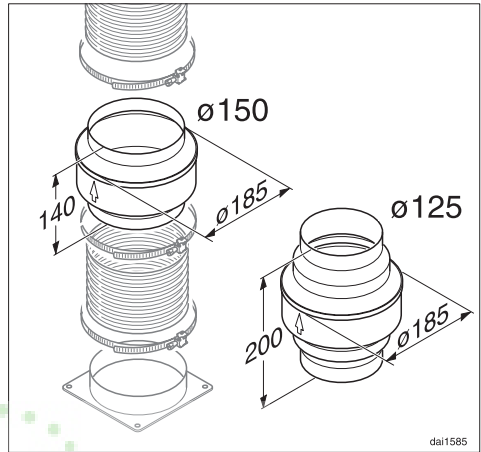

Besides appropriate insulation of the exhaust ducting, we recommend installing a condensate trap to collect and evaporate any condensation which may develop. This is available for ducts $\varnothing 5"$ (125 mm) or $\varnothing 6"$ (150 mm).

When installing a condensate trap, ensure that it is positioned vertically and if possible directly above the exhaust outlet of the ventilation hood. The arrow on the casing indicates the exhaust flow direction.

⚠ WARNING
TO REDUCE THE RISK OF
FIRE, ELECTRIC SHOCK, OR
INJURY TO PERSONS,
OBSERVE THE FOLLOWING:

All electrical work should be performed by a qualified electrician in strict accordance with national regulations (for USA: ANSI-NFPA 70) and local safety regulations. Installation, repairs and other work by unqualified persons could be dangerous. Ensure that power to the appliance is off while installation or repair work is performed.

- Verify that the voltage, load and circuit rating information found on the data plate (located behind the grease filter), match the household electrical supply before installing the hood.

If there is any question concerning the electrical connection of this appliance to your power supply, please consult a licensed electrician or call Miele's Technical Service Department. See back cover for contact information.

WARNING:
THIS APPLIANCE MUST BE
GROUNDED

Important

To increase security before the machine is installed, it is recommended to install a protective switch (30 mA).

Important

The hood must be hard wired accordingly:

Black/Red wire: . . . connect to L1 (live)
White wire: connect to N (neutral)
Green wire: . . connect to GND (ground)

Madison
Your Appliance Authority™
800-570-3355

Technical Data

Total connected load. 450 W
– Fan motor * 350 W
– Overhead lighting 4 x 20 W
– Glass edge lighting. 2 x 10 W
Voltage 120 V
Frequency 60 Hz
Fuse rating 15 A
Weight 73 lbs (33 kg)









**Please have the model and serial number
of your appliance available before
contacting Technical Service.**

The Miele logo is displayed in a bold, white, serif font against a black rectangular background.

U.S.A. Miele, Inc.

National Headquarters

9 Independence Way
Princeton, NJ 08540
Phone: 800-843-7231
609-419-9898
Fax: 609-419-4298
www.mieleusa.com

Technical Service & Support Nationwide

Phone: 800-999-1360
Fax: 888-586-8056

TechnicalService@mieleusa.com

Canada Miele Limited

Headquarters and Showroom

161 Four Valley Drive
Vaughan, ON L4K 4V8
Phone: 800-643-5381
905-660-9936
Fax: 905-532-2290
www.miele.ca
professional@miele.ca
(commercial enquiries)

MieleCare National Service

Phone: 800-565-6435
905-532-2272
Fax: 905-532-2292
customercare@miele.ca
(general and technical enquiries)

Germany

Miele & Cie. KG
Carl-Miele-Straße 29
33332 Gütersloh

