

Operating Instructions

Dishwasher

Dear Customer,

Thank you for choosing this quality product from ASKO.

We hope it will meet your expectations and fulfill your needs for many years to come. Scandinavian design combines clean lines, everyday functionality, and high quality. These are key characteristics of all our products and the reason they are greatly appreciated throughout the world.

To get the most out of your new dishwasher, we recommend that you read the operating instructions before using it. The operating instructions also include information on how you can help protect the environment.

AjMadison
Your Appliance Authority™
800-570-3355



ASKO D5894 XXL FI
Operating Instructions

Contents

Before washing for the first time	3	Troubleshooting	32
Read the operating instructions	3	Performance information	35
Be careful with certain materials	3	Service	36
Checking water hardness	3	Warranty	37
Program key	3	How to contact ASKO Appliances Inc.	37
Important safety instructions	4	Quick guide	40
Winter storage/Transport	4		
Overflow guard function	4		
Care and maintenance instructions	4		
Packing material	4		
Disposal	5		
Child safety	6		
Activate child lock (button lock)	6		
Dishwasher components	7		
Dishwasher baskets	8		
Front panel	12		
Detergent/Rinse Aid Dispenser	12		
Economic dishwashing	13		
Fragile dishes	14		
Dishwashing	15		
Load the baskets correctly	15		
Check that the spray arms can rotate freely	16		
Add detergent	16		
Press the main power switch until the display lights up	18		
Select the program	18		
Select options	20		
Press Start/Stop and close the door	22		
After dishwashing	22		
Special settings	23		
Time remaining	25		
Status light	26		
Care and maintenance instructions	27		
Rinse aid	30		
Error messages	31		

Before washing for the first time

Do you need this Use&Care Guide in Spanish? Log on to www.askousa.com/customer-care to download.

¿Necesita estas Instrucciones de uso y cuidado en español? Entre en www.askousa.com/customer-care y descárguela.

Read the operating instructions

Read through the operating instructions before using the dishwasher, especially the sections Important safety instructions, Child safety, and Dishwashing.

Be careful with certain materials

Read the section Fragile dishes before dishwashing porcelain with unglazed decoration or other utensils made from plastic, wood, or crystal that you value.

Checking water hardness

Contact the local water utility to check the water hardness in your area. This is important to determine how much detergent and rinse aid to use.

Program key

Some dishwashers include program keys in different languages. Attach the program key in the appropriate language to the top of the door.

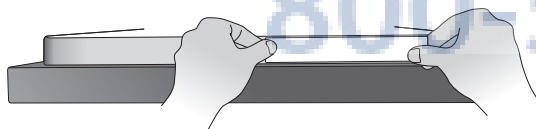

Important safety instructions



SAVE THESE INSTRUCTIONS FOR FUTURE REFERENCE

WARNING!



This manual does not cover all possible conditions and situations that may occur. Common sense and caution should always be used when installing, operating, and maintaining any appliance.

- Read all instructions before using the dishwasher.
- Dishwashers must be electrically grounded. Read the Installation Instructions for details.
- Use the dishwasher only for its intended purpose.
- Do not run the dishwasher while you are out of the home.
- Use only automatic dishwasher detergents and rinse agents.
- To reduce the risk of injury, keep detergents and rinse aids out of the reach of children.
- Do not load sharp items near the door; you could damage the door seal.
- Place sharp knives in the cutlery basket with the sharp ends down to avoid the risk of cut-type injuries.
- Do not wash plastic items unless they are marked “dishwasher safe” or the equivalent. For items not marked, check the manufacturer’s recommendations. Items not dishwasher safe could become deformed or melt and create a potential fire hazard.
- Do not operate the dishwasher unless all enclosure panels are properly in place (i.e., guard plate, access panel, toe kick, etc.).
- Do not tamper with controls by removing or changing.
- Do not abuse, sit on, or stand on the dishwasher door or baskets.
- To reduce the risk of injury, do not allow children to play in or on a dishwasher.
- Under certain conditions, hydrogen gas may be produced in a hot water system that has not been used for two weeks or more. **HYDROGEN GAS IS EXPLOSIVE.** If the hot water system has not

been used for two weeks, before using the dishwasher turn on all hot water faucets and let the water flow from each for several minutes. This will release any accumulated hydrogen gas. As the gas is flammable, do not smoke or use an open flame during this time.

- When removing an old dishwasher from service or discarding it, remove the door to the washing compartment.
- Do not store or use combustible materials, gasoline, or other flammable vapors and liquids in the vicinity of this or any other appliance.
- Disconnect electrical power to dishwasher before servicing.
- Repairs should be done by a qualified technician.
- Read the grounding instructions in the installation instructions.

Winter storage/Transport

- Store the dishwasher where the temperature remains above freezing.
- Avoid long transport distances in very cold weather.
- Transport the dishwasher upright or laying on its back.

Overflow guard function

The overflow protection starts pumping out the machine and turns off the water supply if the water level in the dishwasher exceeds the normal level. If the overflow protection is triggered, turn off the water supply and call the Customer Care Center.

Care and maintenance instructions

When cleaning the edge around the door, use only a slightly damp cloth. Do not spray water around the edge! Moisture can make its way into the lock, which contains electrical components.

Packing material

Please sort waste materials in accordance with local guidelines.

Important safety instructions



Disposal

- When the machine has reached the end of its service life and is to be disposed of, it should immediately be made unusable. Pull out the power cable and cut it as short as possible.
- The dishwasher is manufactured and labeled for recycling.
- Contact your municipality for information about where and how your dishwasher can be recycled correctly.



Child safety



TIP!

Dishwasher detergents and rinse aids are corrosive, so always keep them out of reach of children.

- Should a child swallow dishwasher detergent or rinse aid, give plenty to drink immediately, i.e., one or two glasses of milk or water. Do not try to induce vomiting. Seek medical advice immediately: Call the National Capital Poison Center at 1-800-222-1222.
- Always close the door and start the dishwasher as soon as you put in the detergent.
- Always keep small children away from the machine when it is open. There may be some detergent residue left inside the machine.
- If dishwasher detergent gets in someone's eyes, rinse them with plenty of water for at least 15 minutes.
- Do not allow children to use or play in or on the dishwasher.
- Load all long and sharp items in the knife basket or utensil basket in the middle rack. If this is not possible, load sharp objects with the pointed end facing the back of the dishwasher. Sharp items loaded in the cutlery basket should be loaded with pointed ends down.

Activate child lock (button lock)

You can activate the child lock (button lock) to prevent children from starting the dishwasher (see the section Special settings).

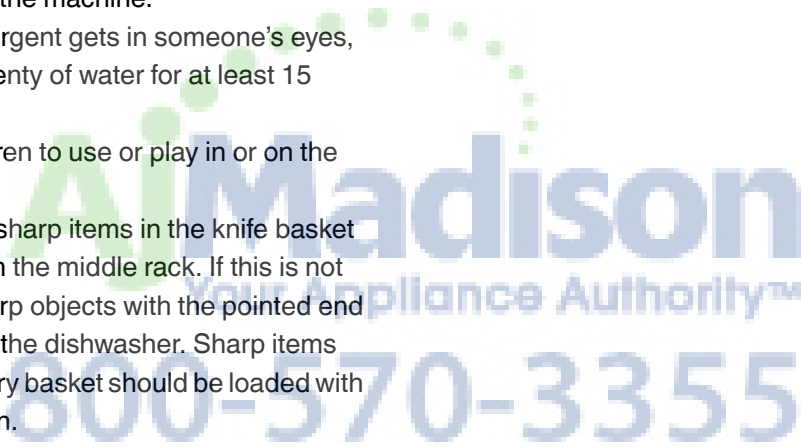

Dishwasher components*

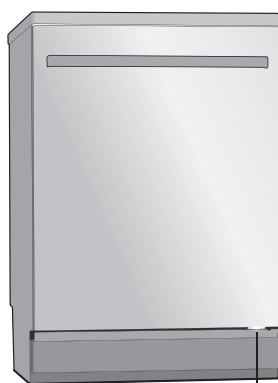

Status light

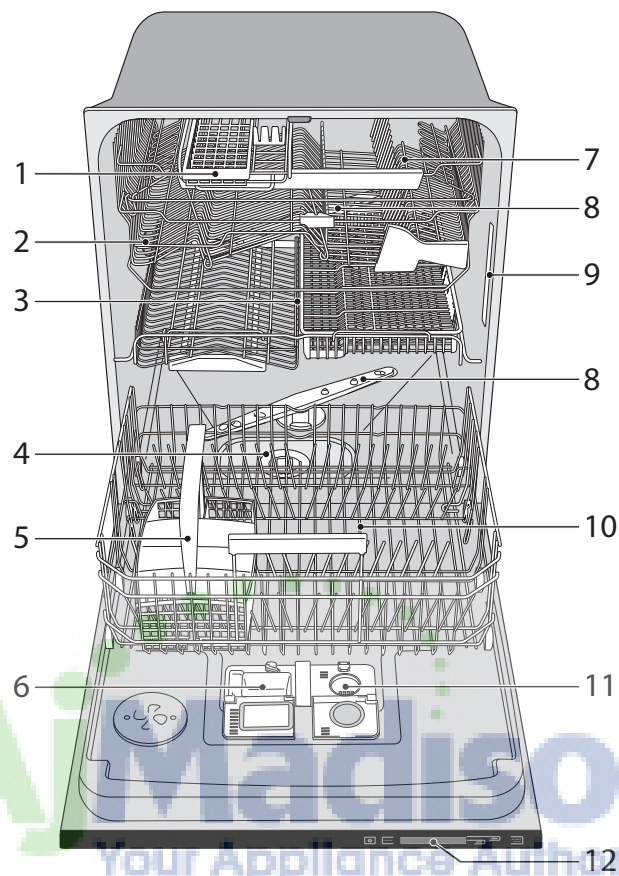

- | | |
|--------------------------|---------------------------|
| 1. Knife basket | 7. Upper basket |
| 2. Interior light | 8. Spray arms |
| 3. Middle basket | 9. Serial number plate |
| 4. Filters | 10. Lower basket |
| 5. Cutlery basket | 11. Rinse aid compartment |
| 6. Detergent compartment | 12. Panel |

*Specifications may differ depending on the model and market.

Dishwasher baskets*

Upper basket

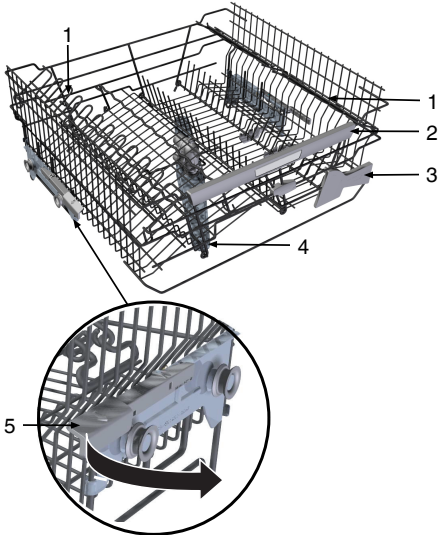

1. Wine glass shelf
2. Handle
3. Knife guard
4. Spray arm
5. Locking handle for upper basket

Raising the upper basket

1. Pull out the upper basket.
2. Grab the sides of the upper basket with both hands and lift it up.

Lowering the upper basket

1. Pull out the upper basket.
2. While holding the basket, pull out the two locking handles (5) on either side to lower the upper basket.

Middle basket

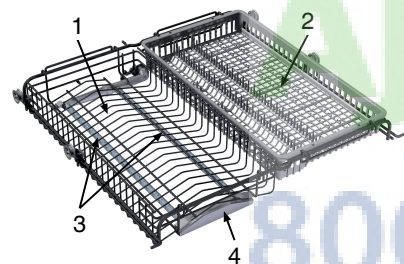

1. Wire basket for cups, small glasses, or bowls
2. Utensil basket for ladles, whisks, food turners, serving cutlery, and similar items
3. Spray pipes
4. Handle

The two baskets in the middle basket can be removed, or the entire middle basket can be removed, to create more space between the upper and lower baskets if larger items are being washed.

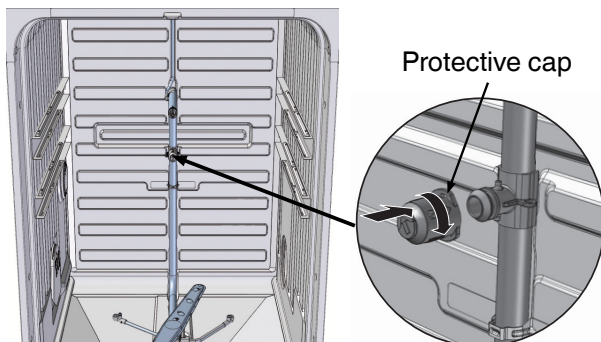

NOTE!

Fit the supplied protective cap if the wire basket with spray pipes or the entire middle basket is removed. Don't forget to remove the protective cap when the wire basket with spray pipes or the entire middle basket is reinstalled.

*Specifications may differ depending on the model and market.

Dishwasher baskets*

Lower basket

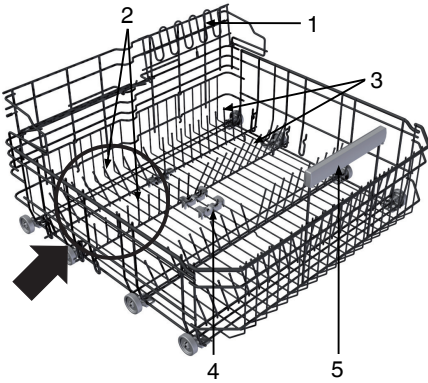

1. Wine glass shelf
2. Fold-down bowl support left
3. Fold-down plate support right
4. Forward mount for plate support (used for plates with a diameter greater than 9 3/4" (25 cm))
5. Handle

NOTE!

Plastic items should not be placed in the circled area of the lower basket as they can be damaged by the heat. Plates, on the other hand, can be placed here for warming (applies to the Crockery warming program).

Knife basket

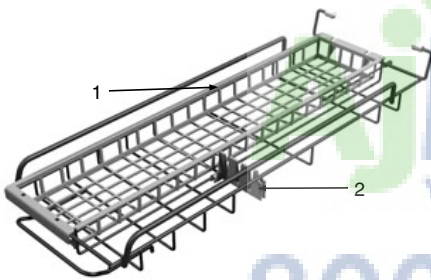

1. Basket
2. Knife support

Cutlery basket

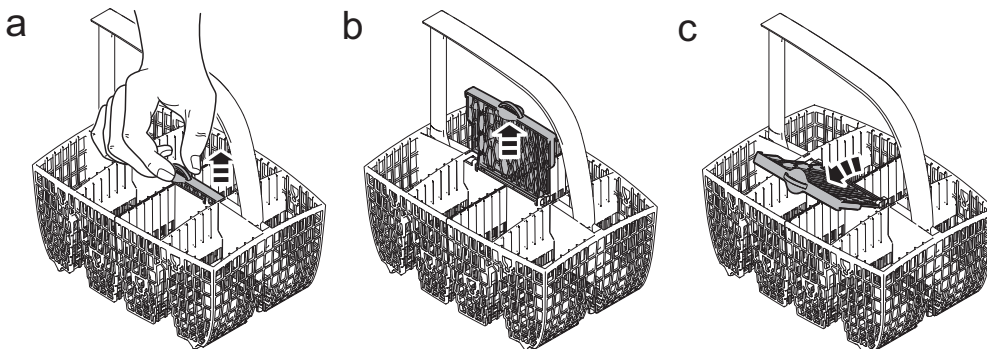

*Specifications may differ depending on the model and market.

Dishwasher baskets*

Extra cutlery basket (disassembly)

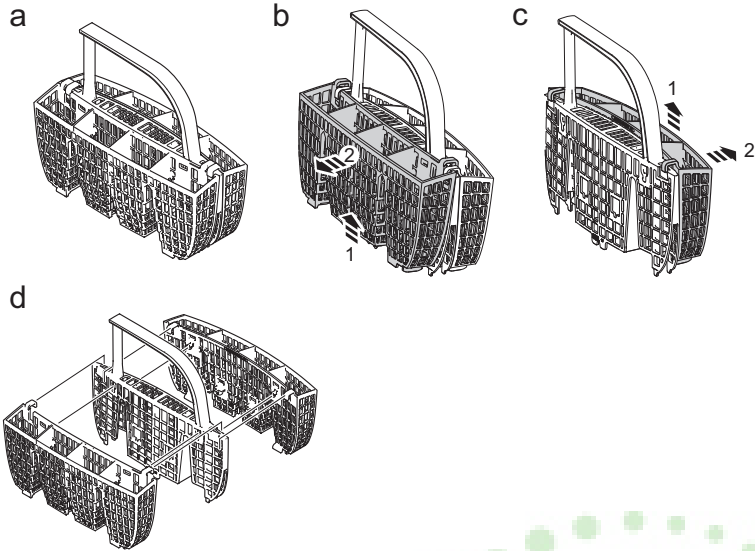

Extra cutlery basket (assembly)

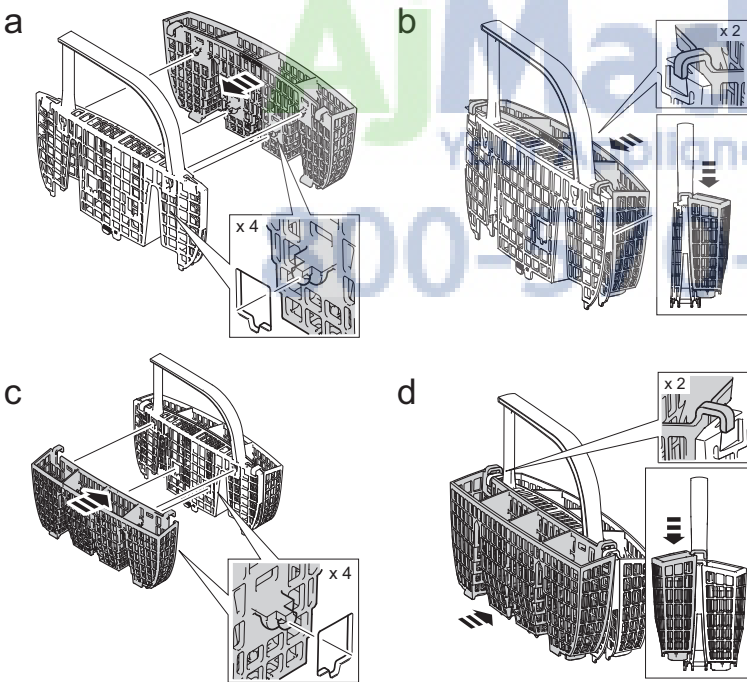

TIP!

The disassembled parts can also be mounted on the large cutlery basket to make an even larger cutlery basket.

*Specifications may differ depending on the model and market.

Dishwasher baskets*

Positioning of extra cutlery basket

Upper basket

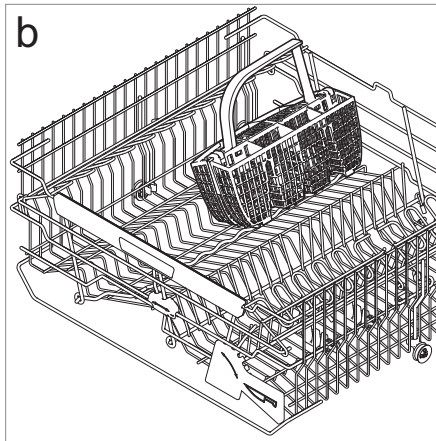
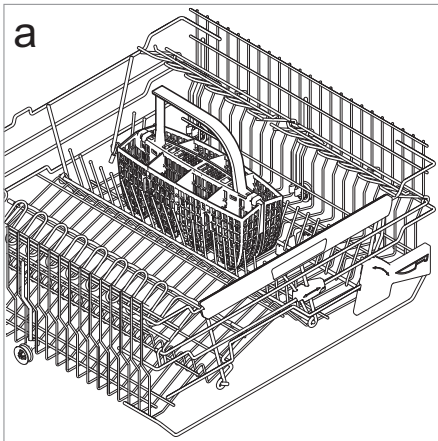

Lower basket

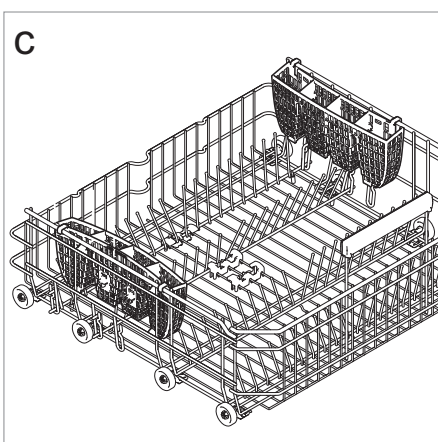
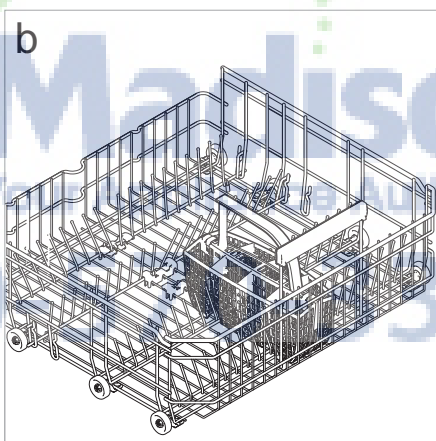
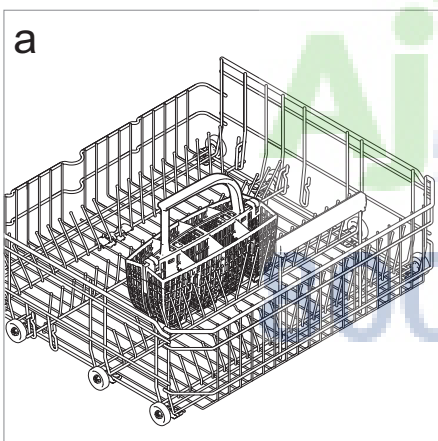

*Specifications may differ depending on the model and market.

Front panel

The panel is fitted with touch buttons with audible feedback (see the chapter Special settings).

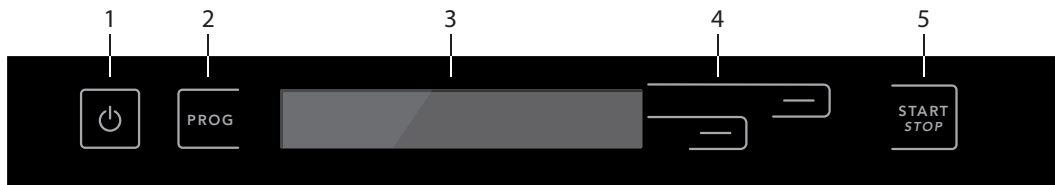

- | | |
|----------------------|-----------------------|
| 1. Main power switch | 4. Navigation buttons |
| 2. Program selector | 5. Start/Stop |
| 3. Display | |

NOTE!

- The touch buttons only react to use when the door is open. Wait a moment before pressing the touch buttons after opening the door.
- Two minutes after the last button press, the panel backlight enters energy saving mode. Press the main power switch once to reactivate the panel.
- Keep the touch buttons clean and free from grease. Wipe them clean with a dry or slightly damp cloth. Never use cleaners – they can scratch the surface. Use the main power switch to turn off the dishwasher before cleaning the touch buttons to avoid activating any buttons unintentionally.

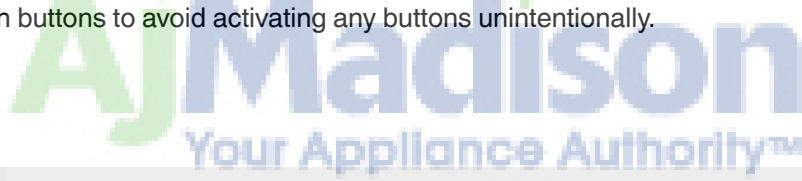

Detergent/Rinse Aid Dispenser

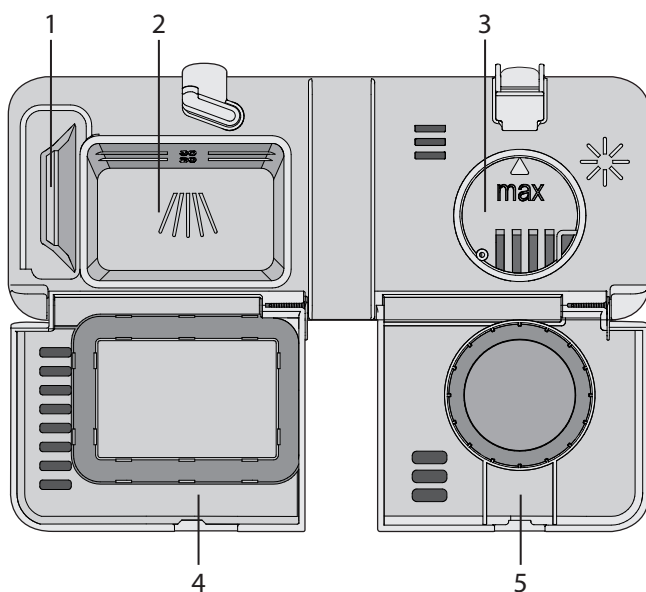

1. Prewash detergent compartment
2. Main wash detergent compartment
3. Rinse aid compartment
4. Detergent compartment lid
5. Rinse aid compartment lid

Economic dishwashing

Run programs only with a full load

Wait until the dishwasher is fully loaded before running a program, this way you save energy. Use the Rinse & Hold program to rinse the dishes if there are any unpleasant odors while you wait for the dishwasher to become fully loaded.

Run programs at a lower temperature

If the dishes are only lightly soiled, you can select a lower temperature with certain programs. See also the section Select options in the chapter Dishwashing.

Select a program with Short dry

To save energy, use Short dry. The drying result will be better if, once the program is finished, you leave the door slightly open.

Do not rinse under running water

Simply scrape off large food particles before loading the dishwasher.

Choose a green detergent

Read the environmental declaration on the packaging!

Connect to cold water...

If you use oil or electricity to heat your home.

Connect to hot water (max. 160 °F (70 °C))...

If you use district heating, solar power, or geothermal power to heat your home. Choosing a hot water connection cuts program times and reduces the dishwasher's electricity consumption.

Fragile dishes

Some cookware is not dishwasher safe. This can be for several reasons. Some materials cannot withstand high temperatures, others can be damaged by dishwasher detergent.

Fragile decoration

Porcelain with decoration on top of the glazing (the items feel rough) should not be washed in a dishwasher.

Crystal / Glass

Position items so that they do not touch each other during the wash. Use the lowest possible wash temperature and the shortest possible program. Select No dry. Antique and very fragile items should not be washed in a dishwasher.

Glass washed in a dishwasher at high temperatures can gradually develop a gray film that cannot be removed. Wash fragile glasses at a low temperature and with a small amount of detergent.

Silver

Silver and stainless steel items should not come into contact, as the silver can become discolored.

Cutlery with glued handles

Some types of glue are not dishwasher safe. In such cases, the handles may loosen.

Wood

Wooden items should only be washed in a dishwasher if marked dishwasher safe.

Aluminum

Aluminum can lose its shine if washed in a dishwasher. However, good quality aluminum pans can be washed in a dishwasher, even if some of the shine will be lost.

Plastic items

Avoid washing plastic items that cannot withstand high temperatures.

Your machine is equipped with a turbo dryer, which improves the drying of plastic and other items.

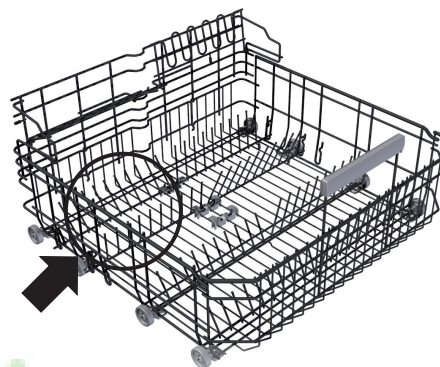

NOTE!

Plastic items should not be placed in the circled area of the lower basket as they can be damaged by the heat.

Dishwashing

Below are step-by-step instructions to help you achieve the best possible dishwashing results.

1 Load the baskets correctly

Do not rinse dishes under running water before loading them in the dishwasher. Simply scrape off large food particles before loading the dishwasher. Place glasses, cups, bowls, side plates, and saucers in the upper basket. Wine glasses are placed on the wine glass shelf (if fitted). Place sharp knives in the special knife basket at the top of the dishwasher, or in the knife stand on the right (if equipped).

NOTE!

All dirty surfaces should face in and down!

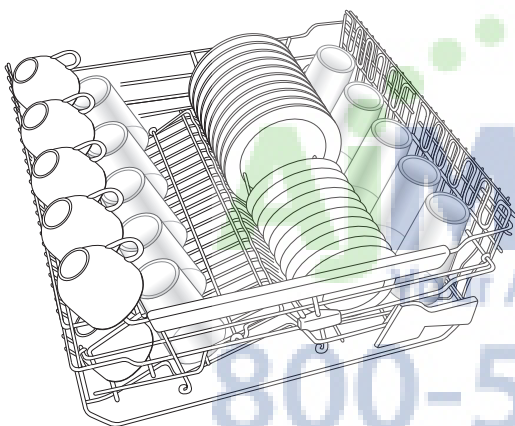

The middle basket's wire basket with spray pipes is suitable for short objects, such as cups, small glasses, and bowls. The middle basket's utensil basket has space for ladles, whisks, serving cutlery, and similar items.

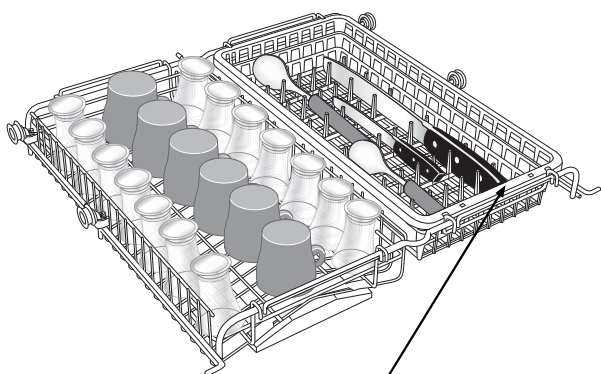

Do not place bowls or cups in the utensil basket!

The two baskets in the middle basket can be removed, or the entire middle basket can be removed, to create more space between the upper and lower baskets if larger items are being washed.

NOTE!

Fit the supplied protective cap if the wire basket with spray pipes or the entire middle basket is removed. Don't forget to remove the protective cap when the wire basket with spray pipes or the entire middle basket is reinstalled. See the section Dishwasher baskets.

Place plates, side plates, serving dishes, pots, and cutlery (in the cutlery basket) in the lower basket. Lower the fold-down plate supports when washing pots.

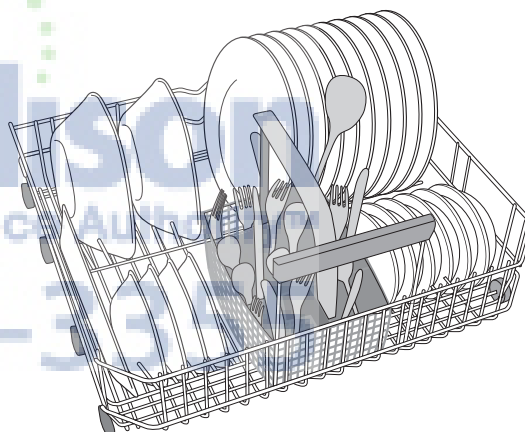

Place cutlery with the handles facing down, except for knives, and spread them out as much as possible. Ensure that spoons do not stack inside each other. The cutlery basket is placed in the lower basket.

WARNING!



Knives and other pointed items must be placed with the points down in the cutlery basket or horizontally in other baskets.

Do not place cutlery made of different materials, such as silver and stainless steel, in the same place (risk of discoloration).

Dishwashing

The cutlery basket has a fold-down section in the middle for small items, or small shafts, such as electric whisk attachments.

See the section Fragile dishes if you want to wash items that may be considered fragile.

2 Check that the spray arms can rotate freely

3 Add detergent

We recommend that you use only unscented, granular automatic dishwashing detergent.

Using the wrong detergent could cause flooding and/or damage your dishwasher. Do not use detergent that has been wet and is clumped. Also, check the expiration date on the container.

The amount of detergent needed can vary due to differences in water hardness. To determine the water hardness in your area, contact your local water utility or area water softening company. The harder the water, the more detergent you may need. Refer to the chart below for the recommended detergent amounts based on water hardness. Remember, you should adjust the amount of detergent you use by small amounts until you find the correct amount. Twelve grains and higher is extremely hard water and detergent alone may not be enough. You may need to use a water softener to maximize the performance of your dishwasher. Also, in areas with hard water (9+) you may need to wash at lower temperatures to prevent hard water deposits from forming in tank and wash system. In hard water areas, both the dishes and the machine can develop a white or gray film after a while. If this happens, run the Heavy wash program with high temperature and two tablespoons of citric acid or commercially available dishwasher cleaner in the detergent compartment (with no dishes in the machine).

NOTE!

We recommend that you do not add prewash detergent for the programs Quick wash or Super Quick wash.

NOTE!

If you use a dishwashing detergent with a rinse aid additive, you should not fill the rinse aid dispenser. This could cause a film on your dishes.

WARNING!



Children must be supervised – dishwasher detergent is corrosive!

NOTE!

Use only dishwasher detergent! Liquid hand-washing detergent must not be used as the foam that forms prevents the dishwasher from operating effectively.

Dishwasher tablets

Halve the tablet if it is difficult to close the dispenser lid. There is a risk that the detergent will not be released properly if the lid is tight and cannot open correctly.

NOTE!

Dishwasher tablets are not recommended for short programs (less than 75 minutes). Use powder or liquid dishwasher detergent instead.

3-in-1/ All-in-one detergent

Read through the directions for these products carefully. If anything is unclear, contact the detergent manufacturer.

Dishwashing

Recommended detergent amounts based on water hardness	
Water hardness	Detergent amounts
Soft (0-3 grains per gallon)	Prewash 1 teaspoon Main wash 1 to 1-1/2 tablespoons
Medium (4-8 grains per gallon)	Prewash 1 teaspoon Main wash 1 to 2 tablespoons
Hard (9+ grains*)	Prewash 1 teaspoon Main wash 2 to 3 tablespoons

*12 grains and higher is extremely hard water.



Dishwashing

4 Press the main power switch  until the display lights up

5 Select the program
Press the Program selector one or more times until the desired program appears on the display.

Daily wash

A program suitable for day-to-day dishwashing. This program can also clean dried leftovers, but is not intended for burnt food, such as on oven dishes.

Time program

The program adapts to the specified running time or finish time. With this program, it is important to choose a time suited to how dirty the dishes are.

0:30-1:15 Lightly soiled dishes

1:30-2:00 Normally soiled dishes

2:15-3:00 Heavily soiled dishes

Heavy wash

Program for very dirty dishes, such as pans, casserole dishes, and oven dishes. If these dishes do not completely fill the dishwasher, you can add plates and other dishes that can withstand a Heavy wash to fill out the load.

Normal wash

Use to wash normally soiled dishes, and even dishes with dried leftovers, such as plates, serving dishes, cups, glasses, and so on.

Mixed wash

This dishwashing program is used when you have lightly soiled dishes in the upper basket and heavily soiled dishes in the lower basket. This program has a longer program time than Lower half wash.

Upper half wash

You can use this program if you only have cups and glasses that need washing in the upper basket. Lightly soiled dishes can also be placed in the lower basket.

Lower half wash

You can use this program when you only want to wash plates and cutlery in the lower basket. Lightly soiled dishes can also be placed in the upper basket.

Eco wash

Use when you want to save energy. For normally soiled dishes.

Plastic wash

A program intended for washing plastic items that are not dishwasher safe. This program has an extra long drying cycle. Porcelain and glasses can also be washed.

Glass wash

If the dishes are only lightly soiled, you can select Glass wash. This program is intended for glasses and porcelain that have just been used and as such do not require such a powerful program.

This program can be used for fragile dishes. Select No dry if you want to be especially cautious. See also the section Fragile dishes.

Quick wash

This program is used for glasses and porcelain that is lightly soiled, such as coffee cups.

Super Quick wash

Short program lasting about 15 minutes with acceptable results for very lightly soiled dishes.

Rinse & Dry

This program consists of a rinse with heating and drying. This is a suitable program if, for example, you plan to make jam and want to rinse and heat clean glass jars.

Rinse & Hold

Use to rinse dishes while you wait for the dishwasher to become fully loaded.

Crockery warming

Use to warm plates. See the section Dishwasher baskets for how to place the plates.

Dishwashing

Program chart

Program	Options	Pre-washes	Main wash (°F)	Number of rinses	Final rinse temperature (°F)	Consumption values ¹⁾						
						Cold water ²⁾			Hot water ³⁾			Water consumption (gallon)
						Wash time (approx. hours:minutes)	Energy (approx. kWh)	Wash time (approx. hours:minutes)	Energy (approx. kWh)	Wash time (approx. hours:minutes)		
Daily wash	140 °F, Short dry	1	140	2	150	2:00	1.4	1:40	0.8	3.6		
Time program	-	0-2	max. 150	2-3	max. 150	1:30	0.9	1:30	0.7	3.5		
Heavy wash	130 °F, Short dry	2	130	3	140	3:50	1.5	3:10	0.7	4.9		
Normal wash ⁴⁾	115 °F, Short dry	1	115	3	120	2:20	0.9	1:50	0.4	4.2		
Normal wash	150 °F, Short dry	3	150	3	150	2:30	1.5	2:10	0.9	5.5		
Mixed wash	130 °F, Short dry	0	130	2	140	3:10	1.1	3:00	0.9	2.6		
Upper half wash	130 °F, Short dry	1	130	3	140	2:25	1.0	2:00	0.5	4.1		
Lower half wash	130 °F, Short dry	1	130	3	140	2:25	1.0	2:00	0.5	4.1		
Eco wash	120 °F, Short dry	1	120	2	130	2:30	0.9	2:20	0.5	3.5		
Plastic wash	130 °F, Short dry	1	130	2	140	2:45	1.2	2:20	0.7	3.5		
Glass wash	105 °F, Short dry	0	105	2	120	2:00	0.7	1:40	0.4	2.8		
Quick wash	85 °F, No dry	0	85	2	-	0:20	0.2	0:20	0.1	2.6		
Super Quick wash	85 °F, No dry	0	85	2	-	0:15	0.2	0:15	0.1	2.6		
Rinse & Dry	-	0	-	1	120	0:50	0.5	0:40	0.3	0.9		
Rinse & Hold	-	0	-	1	-	0:06	0.01	0:06	0.01	0.9		
Crockery warming	-	0	-	0	-	0:40	0.1	0:40	0.1	0		

1) Consumption values vary depending on the water supply temperature, the ambient temperature, the size of the load, the selected options, and more. For dishwashers equipped with a turbo dryer as illustrated below, the drying time is reduced by some 40-60% for certain programs.

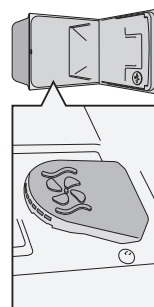







- 2) Connection to cold water, approx. 50 °F (10 °C).
- 3) Connection to hot water, approx. 120 °F (50 °C).
- 4) The energy label performance figures are based on this program.

Dishwashing

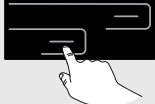
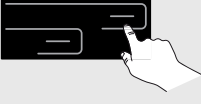





6 Select options



If you do not want to select any more options, press the Program selector to exit the options menu.

		Description
Loading the baskets	 Full load 	This option activates both spray arms and enables you to wash both the upper and lower baskets. This option can be used with all programs except Lower half wash, Upper half wash, Mixed wash, and Crockery warming.
	Upper half load 	You can use this option if you only have cups and glasses that need washing in the upper basket. This option can be used with all programs except Lower half wash, Upper half wash, Mixed wash, and Crockery warming.
	Lower half load 	You can use this option when you only want to wash plates and cutlery in the lower basket. This option can be used with all programs except Lower half wash, Upper half wash, Mixed wash, and Crockery warming.
Delayed start	<ul style="list-style-type: none">  is shown on the display. Press the button to set the desired start time. Press the Start/Stop button or select further options. The dishwasher now counts down the hours or minutes until the program starts. Then the remaining program time appears on the display. 	When you select Delayed start, the dishwasher will start 30 minutes to 24 hours after you press the Start/Stop button. Press and hold Start/Stop for three seconds if you want to cancel the Delayed start option.
Temperature	Press to choose the temperature used in the main wash.	With this option, you can choose the temperature used in the main wash. Select a high temperature if you want to improve dishwashing performance. You can choose a temperature from cold to 160 °F (70 °C) with all programs except Glass wash (from cold to 140 °F (60 °C)) and Plastic wash (from cold to 150 °F (65 °C)). This option can be used with all programs except Time program, Rinse & Dry, Rinse & Hold, and Crockery warming.

Dishwashing

		Description
Drying	Long dry 	<p>Select Long dry for improved drying results. The temperature increases during the final rinse, which improves drying results but increases program time and energy consumption. If you want a program without drying, press the option button again and the symbol turns off. To save energy, select Short dry or No dry.</p> <p>You can select the drying performance for all programs except Time program, Rinse & Dry, Rinse & Hold, and Crockery warming.</p>
	No dry	
	Short dry 	
Time saver	Off	<p>This option shortens the program time, but uses more energy and water. This option can be selected with the Heavy wash, Normal wash, Mixed wash, Upper half wash, and Lower half wash programs.</p>
	On 	
Tab	Off	<p>This option can be activated when using 3-in-1/all-in-one detergents. The dishwashing program automatically adapts to provide the best possible dishwashing and drying results every time. If you deactivate this option, the dishwasher will return to ordinary function for all programs. This option can be used with all programs except Rinse & Dry, Rinse & Hold, and Crockery warming.</p> <p>If this setting is activated, there is no need to add rinse aid since this option disables rinse aid dispensing.</p> <p>NOTE!</p> <p>In order to achieve good dishwashing results, it is essential to check which type of detergent or all-in-one product best suits your needs! Read the detergent packaging carefully for information on proper use. Always follow the directions for use or information on the detergent packaging!</p>
	On 3in1	
Super rinse	Off	<p>Super Rinse adds two extra rinses. This option can be used with all programs except Time program, Rinse & Dry, Rinse & Hold, and Crockery warming.</p>
	On 	
Cool touch	Off	<p>The fan runs for another 30 minutes to cool the dishes before you unload them. This option can be used with all programs except Time program, Rinse & Dry, Rinse & Hold, and Crockery warming.</p>
	On 	
Special settings	Yes	See the section Special settings.
Exit		

Dishwashing

7 Press Start/Stop and close the door

The display shows "Program started". Close the door properly, otherwise the dishwasher will not start.

Stopping or changing a program

If you want to change programs after starting the dishwasher, open the door then press and hold Start/Stop for three seconds. Add more detergent if the lid of the detergent dispenser has opened. Then choose a new program, press Start/Stop, and close the door.

Do you want to add more dishes?

Open the door. The dishwasher stops automatically. Add the dishes, close the door, and the dishwasher resumes the program.

If the dishwasher is turned off using the main power switch or due to a power failure

If the program was not finished, the interrupted program resumes when power is restored.

NOTE!

During drying, the program is interrupted if the power is cut or the door is open for more than 2 minutes.

8 After dishwashing

Once the program has finished, "End" appears on the display.

A buzzer also sounds at the end of the program. See the section Special settings, which describes how to change this function.

A status light also indicates the end of the program. See the section Status light.

Once the dishwasher has finished, it uses only standby power. Turn off the dishwasher using the main power switch if you want to completely cut the power. Turn off the water supply valve after each use.

AjMadison
Your Appliance Authority™
800-570-3355



Special settings







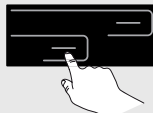

How to open the special settings menu:

 Press the button until Special settings appears on the display.



 Press the button once.

How to save a selection:

Press  or  to save and exit the special settings menu.

		Description
Language	English	You can choose the language used for the display.
	Svenska	To open the language menu directly:
	Dansk	1  Press and hold the button and the main power switch si-
	Norsk	multaneously.
	Suomi	2  Press the button to set your preferred language.
	Français	3  Press the button to save your selection.
	Deutsch	
	Italiano	
	Espanol	
	Русский	
Nederlands		
Child lock	Off	You can activate the child lock (button lock) option to prevent children from starting the dishwasher.
	On 	 and  Press the buttons simultaneously to temporarily deactivate the button lock when you want to start the dishwasher. The button lock is automatically reactivated after 3 minutes.
Buzzer volume	0 (Off), 1-4	The dishwasher uses a buzzer to indicate when a program is finished or when a fault has occurred.
Operation volume	0 (Off), 1-4	This sound is used to confirm each button press.
Temperature unit	°C	Temperatures can be displayed in °C (Celsius) or °F (Fahrenheit).
	°F	
Rinse aid	0 (Off), 1-6	Rinse aid dosage setting.

Special settings

		Description
Water consumption	No. of cycles	Shows the water consumption of the last program, as well as the total number of program cycles the dishwashers has run.
<p data-bbox="137 595 687 633">Finally, press  to save and exit the menu.</p>		



Time remaining

Once you have selected a program and options, the display indicates how long the program took the last time it was used. Once you have started the dishwasher, the display indicates how much program time remains.

This may differ somewhat from time to time depending on the temperature of the water supply, the amount of dishes, the ambient temperature, and other factors.

While the program is running, the time counts down and the remaining program time is shown on the display. The remaining time is shown, for example, as 1:15, which means the program will run for another 1 hour and 15 minutes.

NOTE!

During the first run of each program, the remaining time displayed can be slightly misleading, as the dishwasher is estimating the time. When you run the program a second time, the dishwasher will calculate the remaining time based on the previous duration of the program.



Status light

The status light at the bottom on the dishwasher provides information by means of 3 different colors. Adjust the status light so that it is seen clearly by pulling out or pushing in the transparent plastic strip.

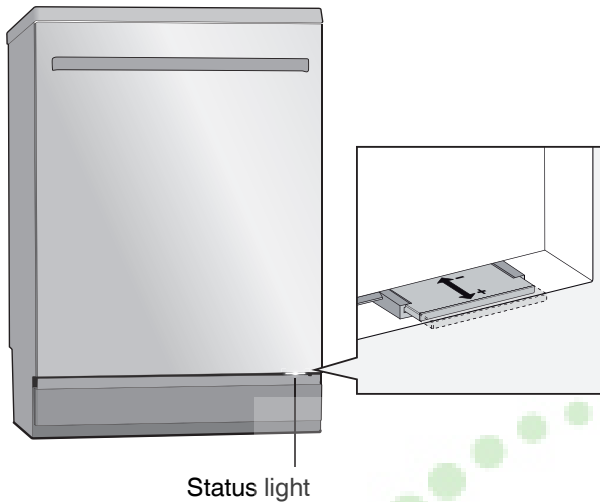

Blue

Load more. The program has started, but you can still load more dishes.

Red

Do not load. You should not load more dishes (risk of poor dishwashing result).

Flashing red

This indicates a fault. See further in the sections Error messages and Troubleshooting.

Green

Unload. The dishwashing program is finished. Standby light for two hours.



Care and maintenance instructions

The dishwasher tub is made of stainless steel and is kept clean through normal use. However, if you have hard water, limescale deposits may form in the dishwasher. If this happens, run the Heavy wash program with high temperature and two tablespoons of citric acid or commercially available dishwasher cleaner in the detergent compartment (with no dishes in the machine).

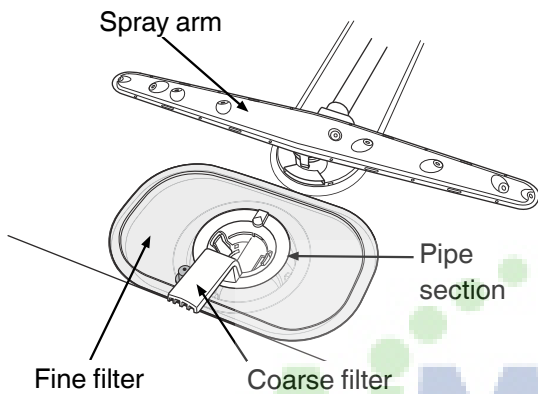

Coarse filter

The coarse filter traps larger food particles, which cannot get past the drain pump. Empty the coarse filter as necessary.

1. Lift the coarse filter by the handle.
2. Empty the coarse filter. Remember to replace it!

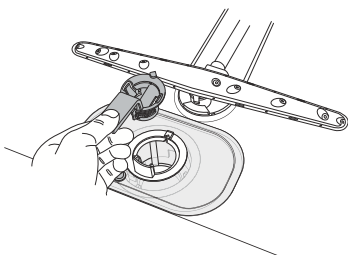

Fine filter

Debris that collects on the fine filter is automatically rinsed away during each wash. However, the fine filter and its pipe section should be cleaned a couple of times a year.

1. Turn the handle counterclockwise once.

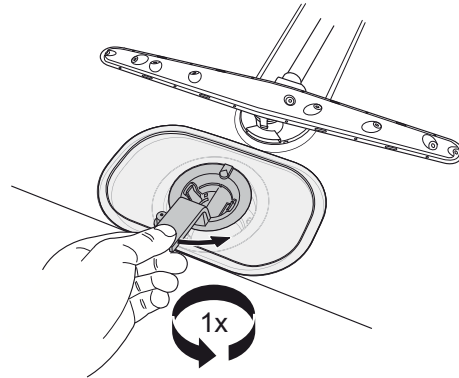

2. Lift the pipe section straight up by the handle. Free the coarse filter to clean the pipe section.
3. Remove and clean the fine filter.
4. Replace in reverse order. Check that the edges seal properly when replacing the fine filter.

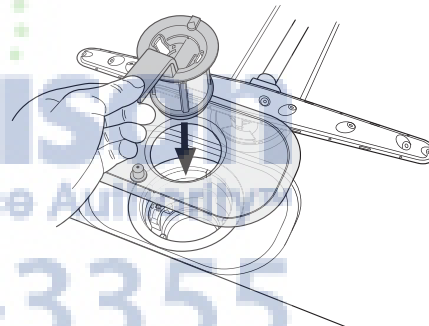

5. Lock the filter in place by turning the handle clockwise to the stop position. The handle should point straight out from the dishwasher.

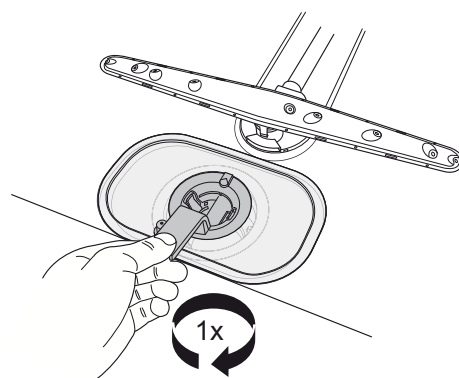

Care and maintenance instructions

NOTE!

The dishwasher must not be used without the filter in place!

Dishwashing efficiency can be affected if the coarse filter is incorrectly fitted.

Drain pump

The pump can be accessed from inside the dishwasher.

1. Cut the power to the dishwasher by unplugging the unit from the power outlet.
2. Remove the coarse filter and pipe section.
3. Remove the small yellow drain pump access cover at the left of the bottom drain (see illustration below).

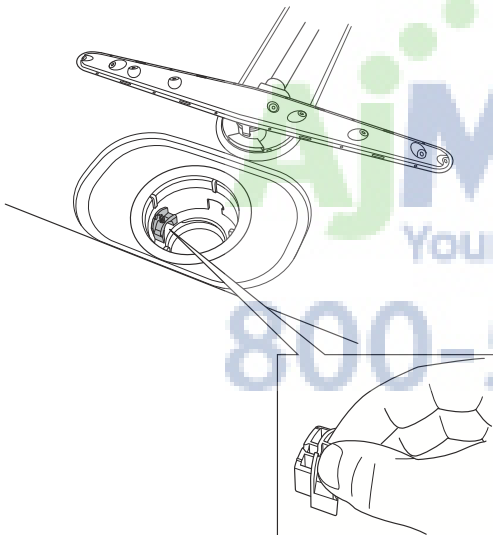

4. By inserting your finger into the hole, you can turn the pump blades to release anything blocking the pump.
5. Reinstall the access cover and filters.
6. Plug the machine in again.

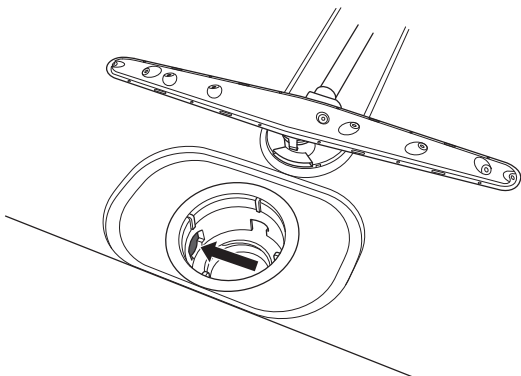

If the dishwasher still does not start and a whirring sound is heard, the overflow protection has been triggered.

- Shut off the water.
- Unplug the unit from the power outlet.
- Call the Customer Care Center.

NOTE!

Do not forget to reinstall the drain pump access cover.

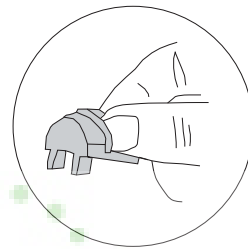

Lower spray arm

Holes and bearings can sometimes become blocked.

1. Pull the lower spray arm straight up to release it.
2. Remove any debris using a needle, toothpick, or some other similar pointed device. The spray arms also have holes underneath.

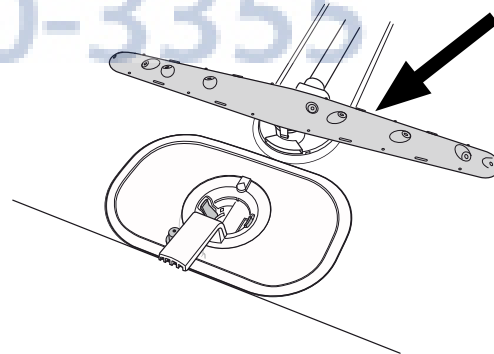

Care and maintenance instructions

Upper spray arm

1. Pull out the basket.
2. Unscrew the spray arm bearings as illustrated to remove the spray arm from the upper basket.

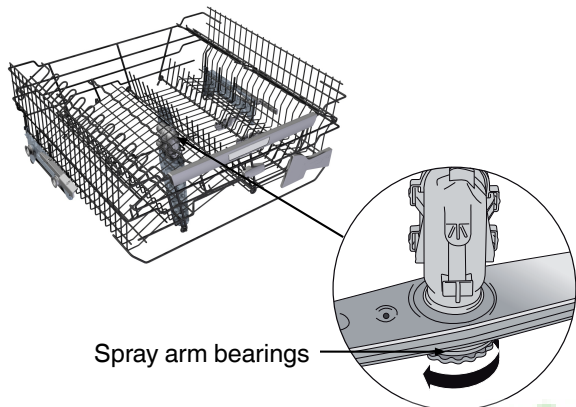

3. Clean the upper spray arm in the same manner as the lower spray arm.
4. Replace the spray arm and screw the spray arm bearings firmly back into place.

Cleaning the middle basket

1. Pull out the basket.
2. Check the holes in the spray pipe.

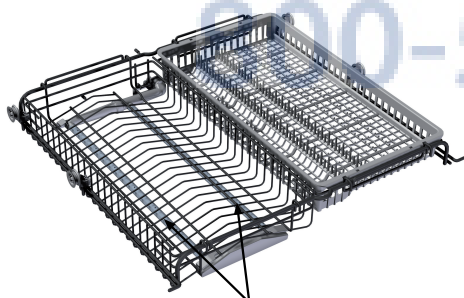

3. Clean with a needle or similar pointed object.

Door

When cleaning the edge around the door, use only a slightly damp cloth (with a little cleaner if necessary).

WARNING!



Do not use a spray bottle or the like around the door lock. This is to ensure that water does not penetrate the door catch and come into contact with the electrical components.

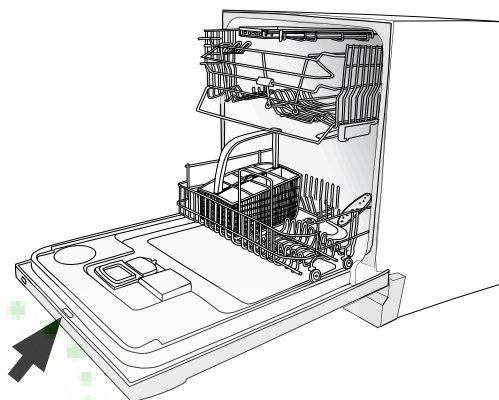

Madison
Your Appliance Authority™
800-570-3355

Rinse aid



Drying is faster if you use rinse aid. When the rinse aid needs topping up, the above symbol lights on the display.

Top up with rinse aid

Top up with rinse aid as follows:

1. Open the rinse aid compartment lid.

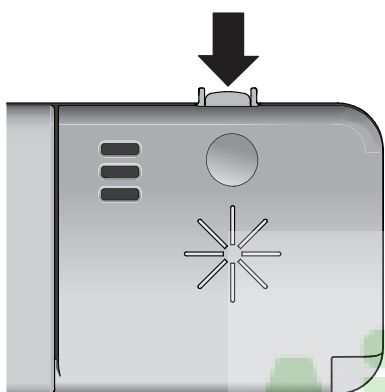

2. Carefully top up with rinse aid. Only add rinse aid to the level marked **max**.

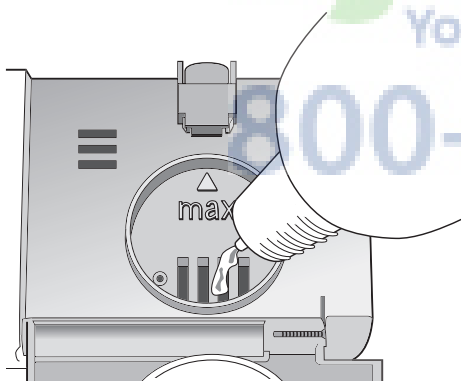

3. Wipe up any spilled rinse aid around the compartment.
4. Close the lid firmly.

NOTE!

After topping up, it may take a while before the symbol goes out.

Select dosage

The rinse aid dispenser can be adjusted between 0 (off) and 6. At the factory, the rinse aid dispenser is set to 1.

Increase the rinse aid dosage:

- If the dishes have water marks.

Reduce the rinse aid dosage:

- If the dishes have a sticky white/blue film.
- If the dishes are streaked.
- Heavy foaming. If you have very soft water, the rinse aid can be diluted 50:50 with water.

Set the dosage

The section Special settings describes how to set the rinse aid dosage.

Ask Madison
Your Appliance Authority™
800-570-3355

Error messages

Display	Action
Overfilling	Call the Customer Care Center.
Water outlet fault	See "Possible causes" in the chapter Troubleshooting.
Water inlet fault	Check that the water supply valve is on.
Inlet valve leakage	Turn off the water supply valve and call the Customer Care Center
Clean filter	Clean the filters. See the section Care and maintenance instructions.

Turn off the machine with the main power switch and then turn it on again to clear the error message from the display.



Troubleshooting

Problem	Possible causes	Action
The dishes are not clean.	The spray arms do not rotate.	Remove the arms and clean them. Check that the dishes are not blocking the spray arms.
	Detergent is too old. Detergent is a perishable product.	Avoid large packages.
	Incorrect detergent dosage.	Dose according to water hardness. Far too much or far too little detergent can result in poor dishwashing results.
	Dishwashing program too weak.	Select a higher temperature or a more powerful program.
	Dishes loaded incorrectly.	Do not cover dishes with large bowls or lids. Avoid placing very tall glasses in the corners of the baskets.
	Glasses and cups have toppled over during the program.	Load the dishes securely.
	The filter is not correctly fitted.	Screw the filter firmly into place. See the section Care and maintenance instructions.
Spots or films on the dishes.	Incorrect rinse aid dosage setting.	See the sections Rinse aid and Special settings.
	Too high temperature and/or too much detergent can cause etching on crystal. Unfortunately, this cannot be repaired, only prevented.	Wash crystal at a low temperature and with a conservative amount of detergent. Contact the detergent manufacturer.
The dishes have a sticky white/blue film.	Rinse aid dosage setting too high.	Reduce the amount. See the sections Rinse aid and Special settings. If you have very soft water, you may want to dilute the rinse aid 50:50 with water.
Spots on stainless steel or silver.	Some types of food, such as mustard, mayonnaise, lemon, vinegar, salt, and dressings, can cause spots on stainless steel if left for too long.	Rinse off these types of food if not starting the dishwasher immediately. Or why not run the Rinse & Hold program?
	All stainless steel can cause spots on silver if they come into contact during dishwashing. Aluminum can also cause spots on dishes.	Silver and stainless steel items should not come into contact during dishwashing.
Spots left after washing.	Lipstick and tea can be difficult to wash off.	Use a detergent with a bleaching agent.
Rattling sound when dishwashing.	The dishes are not correctly placed or the spray arms are not rotating.	Check that the dishes are placed securely. Spin the spray arms to make sure they can rotate.

Troubleshooting

Problem	Possible causes	Action
The dishwasher does not start.	You have forgotten to turn on the main power switch.	Press and hold the main power switch until the display lights up.
	The door is not properly closed.	Check.
	A fuse/circuit breaker has been tripped.	Check.
	The plug is not plugged into the power outlet.	Check.
	The water supply valve is turned off.	Check.
	Overflow/leaks.	Check.
	A whirring sound (the drain pump) is heard from the dishwasher and does not stop when the main power switch is turned off.	Turn off the water supply valve. Pull out the plug and call the Customer Care Center.
	Check that the Delayed start option has not been selected.	Press and hold Start/Stop for three seconds if you want to cancel the Delayed start option.
1 minute appears on the display.	The program is taking longer than estimated.	None. Next time the program is run, the corrected time will be displayed.
Water remains in the dishwasher above the filters.	Blocked drain hose.	Loosen the drain hose from where it terminates. Check that no debris has clogged the hose. Is the cone-shaped part of the drain boot cut to the maximum size of the fitting where it attaches?
	Kink in drain hose.	Check that the hose is free from kinks and sharp bends.
	The filters are blocked.	Clean the coarse and fine filters.
	Debris in the drain pump.	Clean the drain pump. See the section Care and maintenance instructions.
Bad odor in dishwasher.	Dirt around the seals and in corners.	Clean with dish brush and low foaming cleaner.
	Low temperature programs have been selected for a prolonged period.	Run a program with a higher temperature about once a month.
The dishes are not dry enough.	Drying power too low.	Activate the Drying option.
	The dishwasher is not fully loaded.	Fully load the dishwasher.
	Rinse aid needs topping up or dosage is set too low.	Top up with rinse add or increase the rinse aid dosage. See the sections Rinse aid and Special settings.
		Open the door a little once the program has finished.

Troubleshooting

Problem	Possible causes	Action
Cannot close door.	The baskets are not correctly positioned.	Check that the baskets are correctly positioned horizontally, and that the middle basket's water connector is in line with its spray pipe.
		Check that the dishes are not blocking the baskets from sliding properly into place.
The touch buttons do not react when pressed.	You have pressed the touch buttons too soon after opening the door.	Wait a moment then try again.
	Dirt on the touch buttons.	Clean with a dry or slightly damp cloth.
	The door is closed.	Open the door. The touch buttons only react to use when the door is open.
	Child lock (button lock) activated.	See the section Special settings.



Performance information

Energy standard

USA: Energy label FTC, 10 CFR Part 430
Wash performance ANSI/AHAM DW-1-2005

CAN: Energy label CSA C 373-04

Program for test: Normal wash 115 °F (45 °C), Short dry

Loading for wash performance test

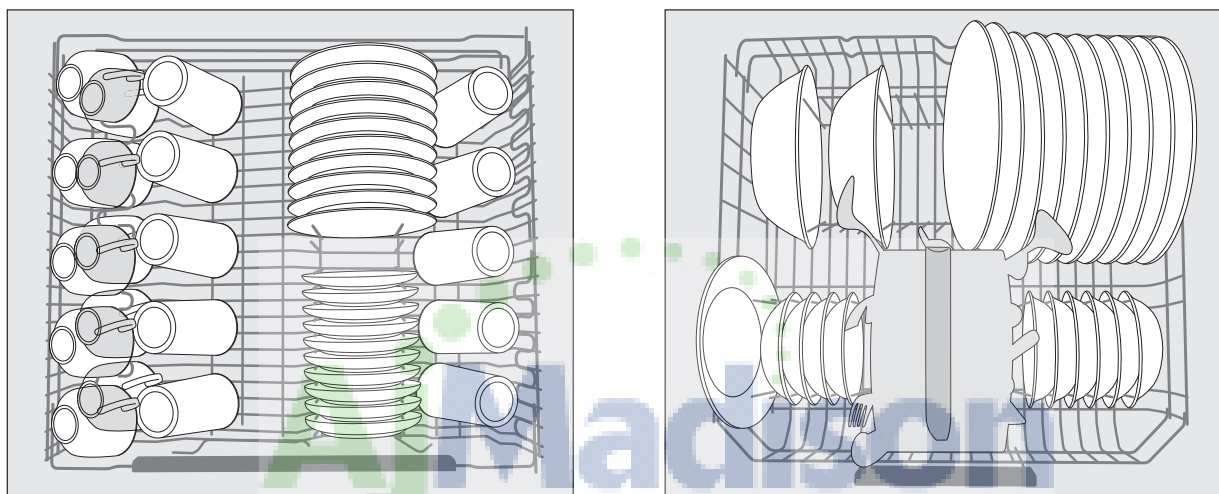

Upper basket with 10 place settings AHAM DW-1 Lower basket with 10 place settings AHAM DW-1
Ensure the upper basket is set to its lowest position.

Technical data

Height: 33-3/4" - 36" (857-915 mm)
Width: 23 1/2" (596 mm)
Depth: 23 11/16" (602 mm)
Weight: 110 lb (50 kg)¹⁾
Water pressure: 4.2–140 psi
Electrical connection: See serial number tag and rating plate.
Rated power: See serial number tag and rating plate.

1) Weight can vary due to different specifications.

Service

It is important to register your product warranty by logging onto "<http://www.askousa.com/customer-care/register-my-appliance/>" and filling out all required fields within 90 days from the date of purchase. After doing so, you will be e-mailed a certificate that will extend the original warranty for one additional year. If you do not have access to the internet, complete the warranty card included with the product and mail it to the address on the warranty card within 90 days from the date of purchase. Cosmetic damage must be reported to your dealer within five days from the date of purchase. After unpacking the washer, thoroughly check the unit for cosmetic damage.

For residential installations only	ASKO Appliances Inc. will pay for:
Length of warranty Two-Year Full From date of purchase.	ASKO replacement parts and/or repair labor to correct defect in materials or workmanship. Service must be provided by an authorized ASKO service agent.
Third Year Full Complete your product warranty registration online at " http://www.askousa.com/customer-care/register-my-appliance/ " within 90 days from the date of purchase to extend the original warranty one additional year. If you do not have access to the internet, complete the warranty card included with the product and mail it to the address on the warranty card within 90 days from the date of purchase.	ASKO replacement parts and/or repair labor to correct defect in materials or workmanship. Service must be performed by an authorized ASKO service agent.
Lifetime	ASKO replacement parts (labor cost not included) for the stainless steel tank if it exhibits a manufacturing defect such as cracking or rusting through. Service must be provided by an authorized ASKO service agent.
For non-residential installations One-year Full Warranty From date of purchase.	ASKO replacement parts and/or repair labor to correct defect in materials or workmanship. Service must be provided by an authorized ASKO service agent.

Service

Warranty

ASKO Appliances Inc. will not pay for:

1. Service calls to:
 - Correct the installation of the appliance.
 - Repair damage due to shipment, delivery, installation, misuse or abuse.
 - Instruct how to use the appliance.
 - Replace house fuses or correct house wiring.
 - Correct house plumbing, including drainage problems related to improper installation.
 - Clean or service air device in drain line.
2. Repair and/or replacement parts for failure of product if appliance is used for other than home/residential use.
3. Damage resulting from accident, fire, floods, acts of God, alteration, misuse, abuse, improper installation, or installation not in accordance with local electrical or plumbing codes.
4. Any shipping costs for parts during the limited warranty period.
5. Replacement parts or repair labor costs for units operated outside the continental United States.
6. Pickup and delivery. ASKO washers are designed to be repaired in the home.

In no event shall ASKO Appliances Inc. be responsible for any incidental or consequential damages.

Some states will not allow the exclusion or limitation of incidental or consequential damages, so this exclusion or limitation may not apply to you. This warranty gives you specific legal rights and you may also have other rights which vary from state to state.

For warranty service, contact our Customer Care Center at the number listed below.

Before calling for service or contacting ASKO Appliances Inc. regarding a warranty issue, make a note of the model, type name, and serial number.

How to contact ASKO Appliances Inc.

Write to us at:

ASKO Appliances Inc.
P.O. Box 940609
Plano, TX 75094-0609
www.askousa.com

Or contact our

Customer Care Center at
1-800-898-1879
www.askousa.com

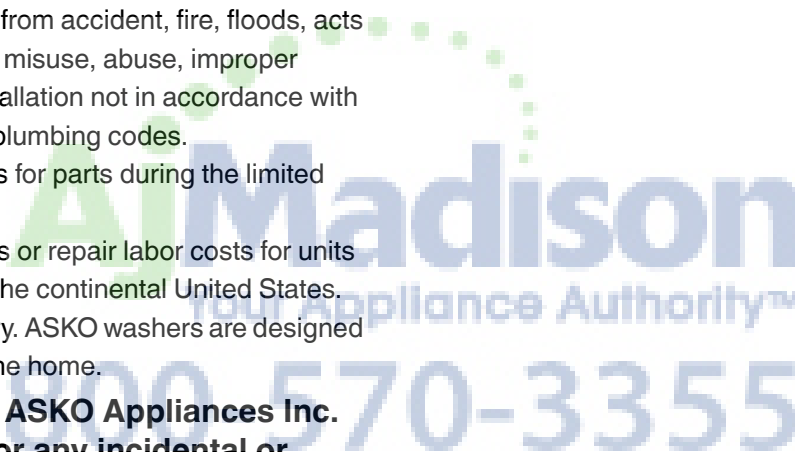

Notes



Notes



Quick guide

- 1 Load the baskets**
Do not rinse dishes under running water before loading them in the dishwasher. Simply scrape off large food particles before loading the dishwasher.
- 2 Add detergent**
The detergent compartment has one smaller compartment for the prewash and one for the main wash.
- 3 Check that the spray arms can rotate freely**
- 4 Press the main power switch  until the display lights up**
- 5 Select a program and any options**
- 6 Press Start/Stop and close the door**

