

TWO HANDLE BAR FAUCET

Description

- 2 handle with high-rise spout

Flow & Valving

- See Chart

Standards

- ASME A112.18.1
- CSA B125
- NSF 61-9
- Listed IAPMO/UPC
- Energy policy act of 1992
- ADA Accessibility Guidelines for Buildings and Facilities - 4.27.4 Controls and Mechanisms 



D153055
SHERIDAN™



Available Colors & Finish

- Chrome
- Stainless Steel (SS)

Warranty

Danze faucets are covered by a manufacturer's limited "lifetime" warranty for manufacturing defects.

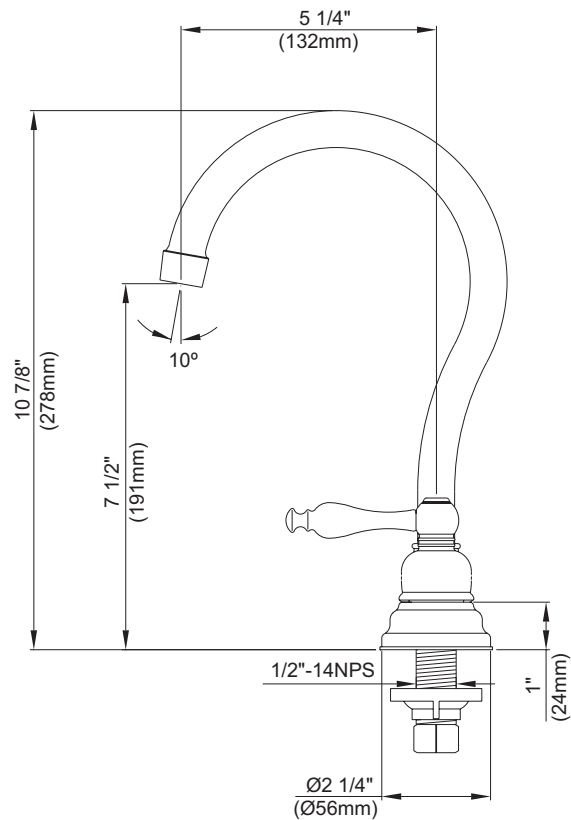
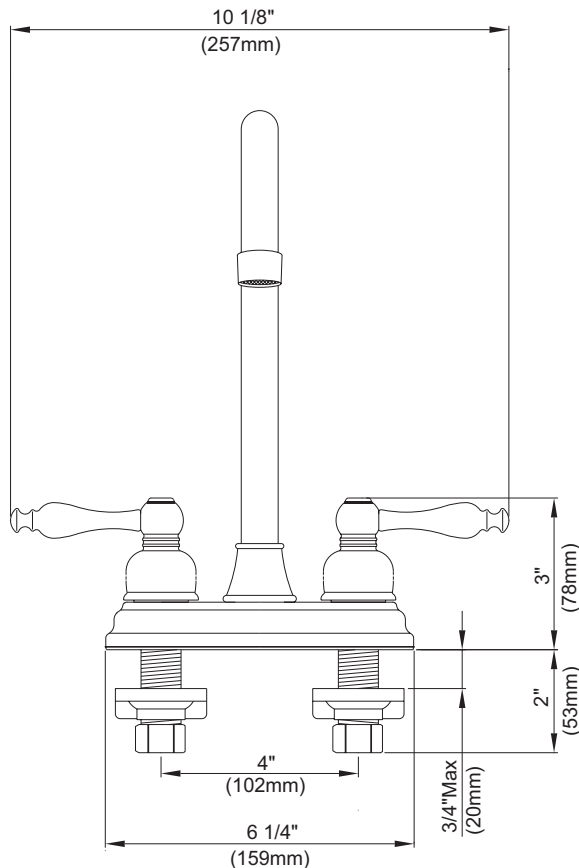
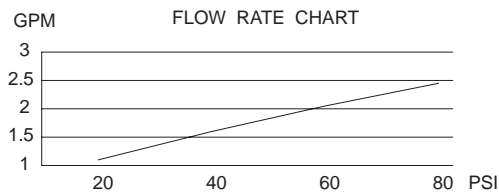

Specific Features: _____ Submitted Model No.: _____

SD153055/03-06.01