

# CROSSOVER 2.0 SERIES

*In a class by itself*

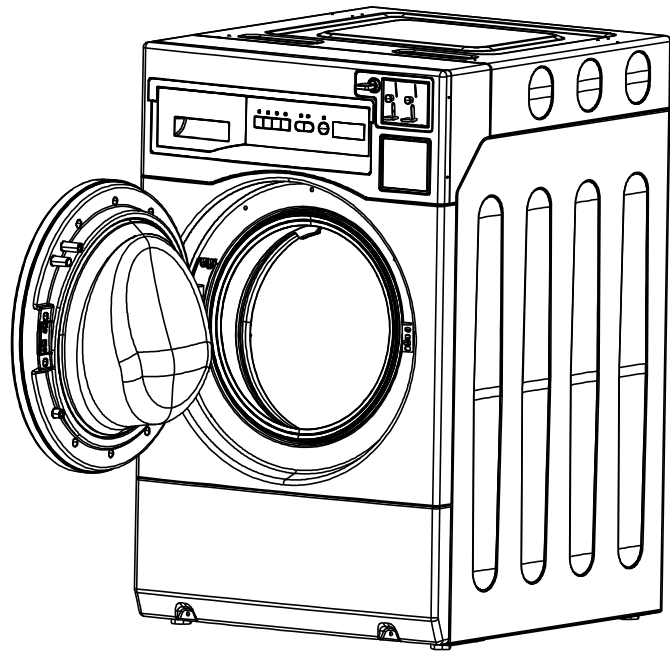

MODEL NO. WHLFP817M  
WHLFP817MI

**WASHER OPERATING MANUAL**

**Intentionally blank**

# Operating Manual

WHLFP817M  
WHLFP817MI

**WARNING:** ALL OPERATING AND MAINTENANCE PROCEDURES SHOWN IN THIS MANUAL MUST BE FOLLOWED DAILY FOR PROPER OPERATION OF YOUR MACHINE.

PLEASE ENTER THE FOLLOWING INFORMATION AS IT APPEARS ON THE MACHINE(S) DATA PLATE(S).

<b>MACHINE MODEL</b>	
<b>MACHINE SERIAL NUMBER(S)</b>	
ELECTRICAL CHARACTERISTICS: _____ VOLTS, _____ PHASE, _____ HZ.	

KEEP THIS MANUAL IN A SECURE PLACE FOR FUTURE REFERENCE.

**Intentionally blank**

# SAFETY AND WARNINGS SIGNS

## Replace If Missing Or Illegible

One or more of these signs must be affixed on each machine as indicated, when not included as part of the front instruction panel.

### LOCATED ON THE FRONT OF THE DETERGENT DRAWER:

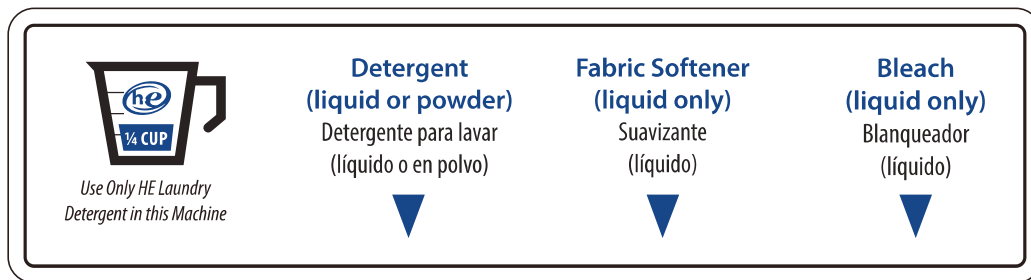

### LOCATED AT THE REAR OF THE MACHINE:

	<b>⚠️ WARNING</b>	<b>⚠️ ADVERTENCIA</b>	<b>⚠️ AVERTISSEMENT</b>
	<p><b>Electrical Shock Hazard</b> Always unplug this appliance from the power supply before attempting any service. Plug into a grounded 3 prong outlet. Failure to do so can result in death or electrical shock.</p> <p>Made in China</p>	<p><b>Riesgo de descarga eléctrica</b> Desenchufe siempre este artefacto del suministro de energía antes de intentar repararlo. Enchufe a un tomacorriente de 3 entradas con descarga a tierra. Si no lo hace puede producirse la muerte o descarga eléctrica.</p> <p>Hecho en China</p>	<p><b>Risque de choc électrique</b> Débranchez toujours cet appareil de la source de courant avant de tenter toute maintenance. Branchez dans une prise murale à trois lames, mise à la terre. Ne pas suivre cette consigne peut conduire à la mort ou à un choc électrique.</p> <p>Fabriqué en Chine</p>

### LOCATED NEXT TO DOOR:



# SAFETY AND WARNINGS SIGNS

## WARNING LABEL FOR POWER CABLE:



## FIRE HAZARD LABEL ADJACENT TO DOOR:

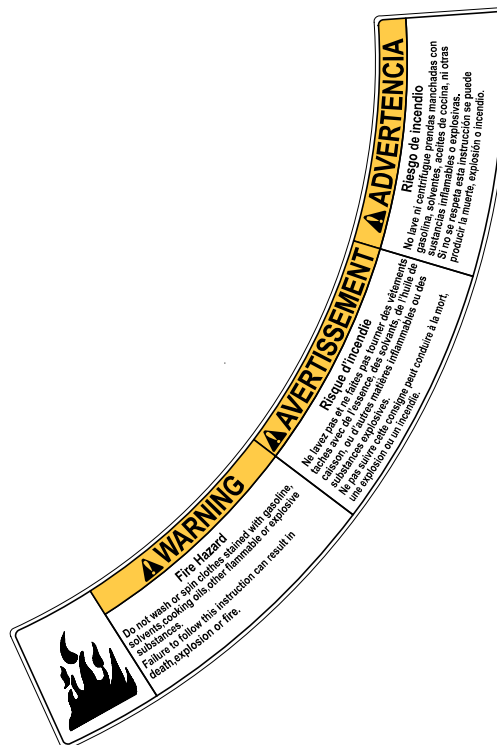

# SAFETY AND WARNINGS SIGNS

## ELECTRICAL HAZARD LABEL ADJACENT TO DOOR:

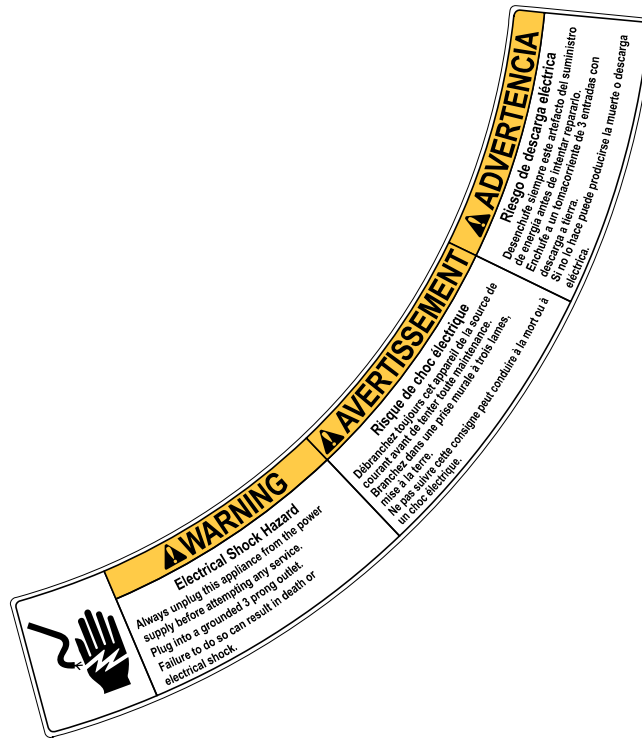

## LOCATED ON THE REAR SHIPPING SECURITY BRACE:

<p>cap bolt sleeve sleeve bolt</p>	<p><b>WARNING</b></p> <ul style="list-style-type: none"> <li>Unscrew the 4 transport bolts, then remove bolts and sleeves to release power cord.</li> <li>Cover the 4 holes left with the caps supplied.</li> </ul> <p><b>NOTE:</b> Failure to remove the transport bolts and sleeves can cause severe noise, and damage to the machine.</p>	<p><b>AVERTISSEMENT</b></p> <ul style="list-style-type: none"> <li>Dévissez les 4 boulons de transport, puis retirez les boulons ainsi que le manchon pour libérer le cordon d'alimentation.</li> <li>Recouvrez les 4 trous laissés vides avec les embouts fournis.</li> </ul> <p><b>Remarque:</b> Si les boulons de transport et le manchon ne sont pas enlevés, cela peut entraîner de fortes vibrations, et dommages à la machine.</p>	<p><b>ADVERTENCIA</b></p> <ul style="list-style-type: none"> <li>Destornille los 4 pernos colocados para el transporte, luego quite los pernos y la funda para liberar el cable de energía.</li> <li>Tape los 4 agujeros que quedan con los casquetes provistos.</li> </ul> <p><b>Nota:</b> Si no se quitan los pernos para el transporte y la funda, se pueden producir ruidos fuertes, y daños a la máquina.</p>
--	--	---	--

If you need to order more safety or warning signs, call the Laundrylux Parts Department at (516) 371-2000, or call your local dealer.

**IMPORTANT SAFETY INSTRUCTIONS**  
**IMPORTANTES MESURES DE SECURITE**

**WARNING -**

To reduce the risk of fire, electric shock, or injury to persons when using your appliance:

**AVERTISSEMENT -**

Pour réduire les risques d'incendie, de choc électrique ou de blessure quand, l'appareil est utilisé:

1. Read all instructions before using the appliance.  
Lire toutes les instructions avant d'utiliser l'appareil.
2. This machine must be installed according to the installation instructions.  
Ce machine doit être vissée sur le plancher selon les instructions d'installation.
3. This machine **MUST** be serviced and operated in compliance with manufacturers instructions. **CHECK DOOR LOCKS EVERY DAY FOR PROPER OPERATION TO PREVENT INJURY OR DAMAGE. IF THE DOOR LOCK FAILS TO OPERATE PROPERLY, PLACE THE MACHINE OUT OF ORDER UNTIL THE PROBLEM IS CORRECTED.**  
**IL FAUT QUE** cette appareil soit entretenue et actionnée conformément aux instructions du fabricant. **CONTROLEZ LA SERRURE DE PORTE TOUS LES JOURS AFIN DE EVITER DES DOMMAGES OU DES RISQUES PERSONNELLES. SI LA SERRURE DE PORTE NE FONCTIONNE PAS, IL FAUT METTRE LA MACHINE HORS SERVICE JUSQU'À LE PROBLEME SOIT CORRIGÉ.**
4. Do not wash articles that have been previously cleaned in, washed in, soaked in, or spotted with gasoline, drycleaning solvents, or other flammable or explosive substances, as they give off vapors that could ignite or explode.  
Ne pas laver des articles qui ont été nettoyés ou lavés avec de l'essence, des solvants pour nettoyage à sec ou d'autres substances inflammables ou explosives, ou que l'on a fait tremper dans ces produits. Ces substances dégagent des vapeurs qui peuvent s'enflammer ou exploser.
5. Do not add gasoline, dry-cleaning solvents, or other flammable or explosive substances to the wash water. These substances give off vapors that could ignite or explode.  
Ne pas ajouter d'essence, de solvants pour nettoyage à sec ou d'autres substances inflammables ou explosives à l'eau de lavage. Ces substances dégagent des vapeurs qui peuvent s'enflammer ou exploser.
6. Under certain conditions, hydrogen gas may be produced in a hot-water system that has not been used for 2 weeks or more. **HYDROGEN GAS IS EXPLOSIVE.** If the hot-water system has not been used for such a period, before using a washing machine, turn on all hot-water faucets and let the water flow from each for several minutes. This will release any accumulated hydrogen gas. As the gas is flammable, do not smoke or use an open flame during this time.  
De l'hydrogène peut être produit dans un système à eau chaude qui n'a pas été utilisé depuis deux semaines ou plus. **L'HYDROGÈNE EST EXPLOSIF.** Si le système à eau chaude n'a pas été utilisé depuis un certain temps, ouvrir tous les robinets d'eau chaude et laisser l'eau couler pendant plusieurs minutes avant d'utiliser une laveuse, l'hydrogène accumulé, le cas échéant, s'échappera. L'hydrogène étant inflammable, ne pas fumer ou utiliser un appareil à flamme nue pendant que l'eau coule.
7. Do not allow children to play on or in the appliance. Close supervision of children is necessary when the appliance is used near children.  
Ne pas permettre aux enfants de jouer sur ou dans l'appareil. Surveiller étroitement les enfants lorsqu'ils se trouvent près de l'appareil qui fonctionne.
8. If the machine is to be discarded, remove the door to prevent accidental entrapment.  
Avant de mettre l'appareil hors service ou de jeter, retirer la porte.
9. Do not reach into the appliance if the tub is moving.  
Ne pas mettre la main dans l'appareil lorsque la cuve bouge.
10. Do not install or store this appliance where it will be exposed to the weather.  
Ne pas installer ou placer cet appareil dans un endroit où il sera exposé aux intempéries.
11. Do not tamper with controls.  
Ne pas trafiquer les commandes.
12. Do not repair or replace any part of the appliance or attempt any servicing unless specifically recommended in the user maintenance instructions or in published user-repair instructions that you understand and have the skills to carry out.  
Ne pas réparer ou remplacer les pièces de l'appareil ou procéder à l'entretien de celui-ci sauf si les instructions visant l'entretien et les réparations qui doivent être effectués par l'utilisateur le spécifient, si vous comprenez bien ces instructions si vous possédez les connaissances nécessaires.



## NOTICE TO: OWNERS, OPERATORS AND DEALERS

IMPROPER INSTALLATION AND INADEQUATE MAINTENANCE, POOR HOUSEKEEPING AND WILLFUL NEGLECT OR BYPASSING OF SAFETY DEVICES MAY RESULT IN SERIOUS ACCIDENTS OR INJURY. TO ASSURE THE SAFETY OF CUSTOMERS AND/OR OPERATORS OF YOUR MACHINE, THE FOLLOWING MAINTENANCE CHECKS MUST BE PERFORMED ON A DAILY BASIS.

## NOTICE À L'ATTENTION DES PROPRIÉTAIRES, UTILISATEURS ET REVENDEURS

UNE INSTALLATION INCORRECTE ET UN ENTRETIEN INADÉQUAT, DE MÊME QUE LA NÉGLIGENCE OU LA NEUTRALISATION DÉLIBÉRÉES DES DISPOSITIFS DE SÉCURITÉ, PEUVENT ÊTRE CAUSÉS DE BLESSURES OU D'ACCIDENTS SÉRIEUX. POUR ASSURER LA SÉCURITÉ DES CLIENTS ET/OU DES UTILISATEURS DE VOTRE MACHINE, IL EST INDISPENSABLE DE PROCÉDER CHAQUE JOUR AUX CONTRÔLES DE ROUTINE CI-APRÈS.

1. Prior to operation of the machine, check to make certain that all operating instructions and warning signs are affixed to the machine and legible. (See the following page of this manual for description and location of the signs.) Missing or illegible ones must be replaced immediately. Be sure you have spare signs and labels available at all times. These can be obtained from your distributor or from Laundrylux.
2. Check the door safety interlock, as follows:
  - (a) OPEN THE DOOR of the machine and attempt to start in the normal manner:  
For coin-operated models, insert the proper coins to start the machine.  
For card-operated models, insert the card to start the machine.

### THE MACHINE MUST NOT START

- (b) CLOSE THE DOOR to start machine operation and, while it is operating, attempt to open the door without exerting extreme force on the door handle. The door should remain locked!

If the machine can start with the door open, or can continue to operate with the door unlocked, the door interlock is no longer operating properly. The machine must be placed out of order and the interlock immediately replaced.

3. DO NOT UNDER ANY CIRCUMSTANCES ATTEMPT TO BYPASS OR REWIRE ANY OF THE MACHINE SAFETY DEVICES AS THIS CAN RESULT IN SERIOUS ACCIDENTS.
4. Be sure to keep the machine(s) in proper working order. Follow all maintenance and safety procedures. Further information regarding machine safety, service and parts can be obtained from your dealer or from Laundrylux through its Technical Support Hotline - (516) 371-0700.

All requests for assistance must include the model, serial number and electrical characteristics as they appear on the machine identification plate. Insert this information in the space provided on the previous page of this manual.

5. WARNING: DO NOT OPERATE MACHINE(S) WITH SAFETY DEVICES BYPASSED, REWIRED OR INOPERATIVE! DO NOT OPEN MACHINE DOOR UNTIL DRUM HAS STOPPED ROTATING!

AVERTISSEMENT: NE PAS FAIRE FONCTIONNER LA (LES) MACHINE(S) AVEC UN DISPOSITIF DE SÉCURITÉ NEUTRALISÉ, RECÂBLÉ OU NON OPÉRATIONNEL! NE PAS OUVRIR LA MACHINE TANT QUE LE TAMBOUR NE S'EST PAS IMMOBILISÉ!

**Intentionally blank**

# Contents

---

Control Panel + Instructions For Use.....	1:1
Heavy Soil + Extra Rinse.....	2:1
Coin Meter .....	3:1
Fault Codes .....	4:1
Operating Mode.....	5.1
Service Mode .....	6.1
Preventive Maintenance .....	7.1
Wash Programs.....	8.1

*The manufacturer reserves the right to make changes to design, material and/or specifications without notice.*

## Control Panel

The display control panel allows the selection of the main wash programs. As desired, options can be selected to modify the wash programs to adjust for load type and soiling.

**Fig. 1** The control panel consists of program selection buttons **(A)**, option buttons **(B)**, a start button **(C)**, and a display **(D)** which shows the time remaining and the price for each program.

In the event of faults, error codes will be displayed. See the “Fault Codes” section of this manual.

### Explanation of the control panel:

- A** Program selection buttons
- B** Option buttons
- C** Start button
- D** Display indicating program time remaining and price of programs.

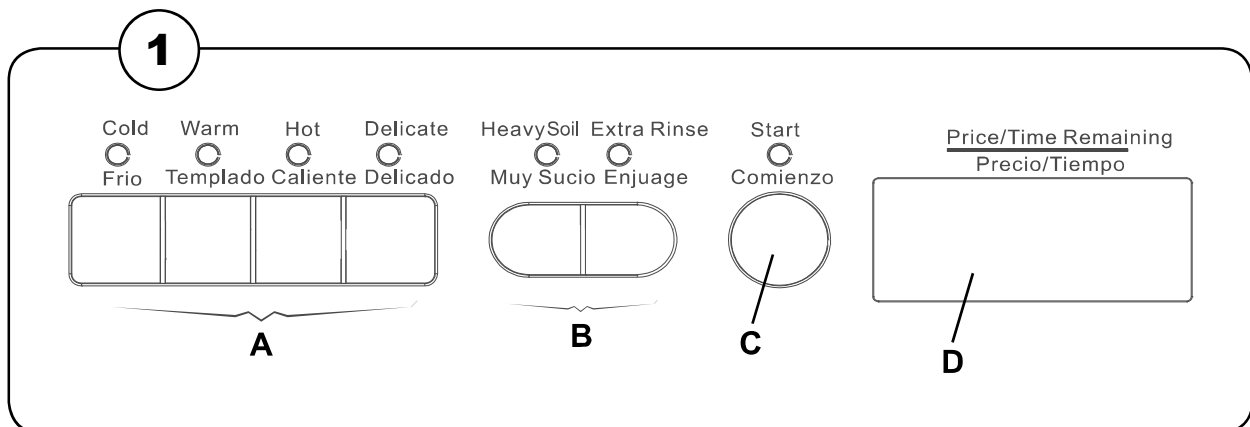

## Washing

- Fig. 2**
- Load garments into the machine and close the door. Do not overload washer.
  - Add liquid detergent, bleach, and fabric softener as recommended on the product label. Do not fill liquid bleach and softener above the “MAX” level line.

**Compartment 1** – Powder or liquid detergent

**Compartment 2** – Liquid softener

**Compartment 3** – Liquid bleach

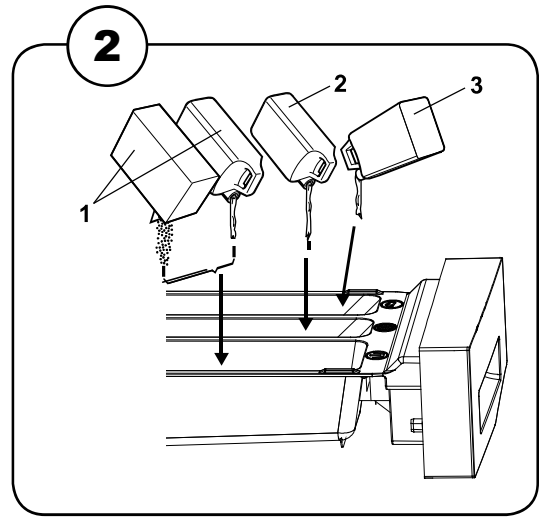

- Fig. 3**
- Press button for the desired program.

**3**

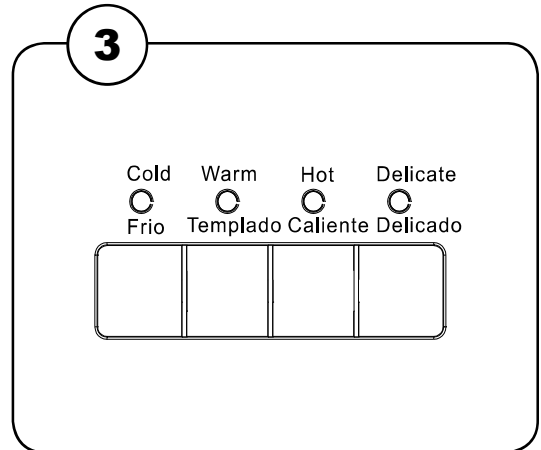

- Fig. 4**
- Press buttons for desired option(s), if any.

**4**

- Pay the price indicated on the display by inserting coins, tokens, or card depending on the payment system in use. For OPL applications no price is displayed.

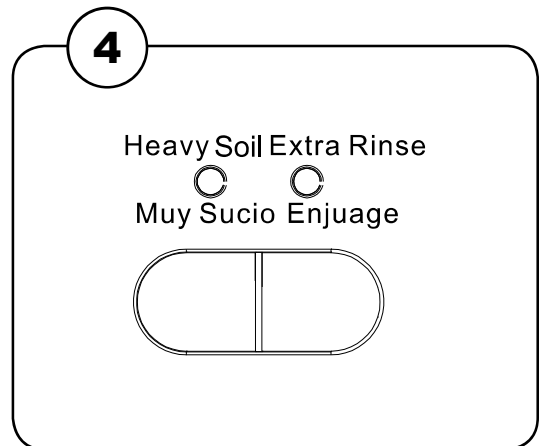
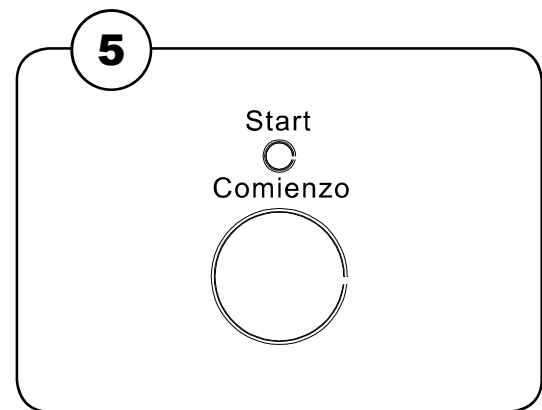

Fig. • Press the Start button.

⑤



## **HE (High Efficiency) Detergent and How Your Washer Functions with Over Suds Conditions**

Your washer is a high efficiency front loading washer. It was specifically designed to use less water than top loading washers while achieving very high quality laundering results. However, highly efficient front loading washers with laboratory verified water levels can still experience over sudsing if regular detergent (liquid or powder) is used, especially if too much detergent is used. We **STRONGLY RECOMMEND** using low sudsing detergent that is clearly marked “HE” and that no more than 1/3 cup be used for a full load.

Bubbles and white suds do **NOT** clean clothes; in fact, excess suds are difficult to fully rinse away and may remain in clothes at the end of the wash cycle. Detergent that is not rinsed away can irritate skin and cause changes to clothing color when heated in a dryer.

Laundrylux has implemented a proprietary software algorithm in this washer to help distinguish between over suds and clogged pump strainer basket conditions. Generally, this washer will complete a wash cycle even if a moderate over sudsing or out-of-balance condition is experienced. Excessive over sudsing, a clogged pump strainer basket (due to accumulated lint and debris), or an extremely out-of-balance load are conditions which may cause a wash cycle to not finish and an error code to be displayed.

If the wash cycle does not complete or you see an error code, the software is performing properly to protect the washer from abnormal operating conditions. If necessary, from the lower left front of the washer carefully remove the pump strainer basket to clean it out according to the instructions in this manual. Please be careful to wait for any hot water in the drum to cool to a safe temperature before removing the strainer since some water will be released.

If you have any questions about operating your washer, please contact your Authorized Distributor or Laundrylux. We want you to enjoy your experience with this fine product and to have the maximum benefit from your purchase.

**Intentionally blank**

## Wash Program Description

The machine offers four standard wash programs, and two optional features. The basic wash programs are Cold, Warm, Hot, and Delicate. The optional features are Heavy Soil and Extra Rinse. The options can be added to the basic wash programs (except for Delicate), in any combination. On coin-operated models, a different price can be charged for each program, and an additional price can be programmed for each of the two option buttons.

The Cold, Warm, and Hot wash programs are comprised of three program segments. These programs begin with the Mainwash which fills to the LOW water level. The duration of the Mainwash can be adjusted using the machine's service mode. The Mainwash water temperature is cold in the COLD program, warm in the WARM program, and hot in the HOT program. The Mainwash fills through the detergent compartment of the detergent drawer. Approximately half way through the Mainwash, the Bleach Compartment of the detergent dispenser is flushed for approximately 15 seconds.

The machine drains following the Mainwash and refills to the HIGH water level for each of the two cold water Rinses that complete the basic programs. Each rinse is followed by a drain and extraction, the final extraction being six minutes in duration. The final rinse flushes the softener compartment of the detergent dispenser.

The Delicate program consists of a four-minute cold water Mainwash and two cold water rinses. Heavy Soil and Extra Rinse options cannot be used with the Delicate program.

Two optional program segments can be added using service mode. The first option is a two minute Prewash that fills to the LOW water level through the Detergent compartment of the detergent drawer. The water temperature is the same as the Mainwash temperature except in the HOT program, which has a warm prewash. The second option is an extra Rinse that gets inserted between the first and last Rinse and also fills to the HIGH water level. LOW and HIGH water level can also be adjusted in service mode.

For OPL use, a Rinse and Spin wash program is available by pressing the EXTRA RINSE button with no wash programs selected. This optional program must be enabled during machine setup. Rinse and Spin is comprised of a two minute cold water fill to the HIGH water level followed by a four minute extraction. Pressing the DELICATE button deselects this wash program.

### Heavy Soil Option

**Fig.** The Heavy Soil option adds a Prewash to any wash program.

- ① Heavy Soil is not available when the Delicate Program is selected.

### Extra Rinse Option

The Extra Rinse option adds one additional cold water rinse to any wash program except the Delicate cycle. The extra rinse repeats the second-to-last rinse.

### Program End

**Fig.** The display will show "donE" when the program ends.

- ② Then door can then be opened.

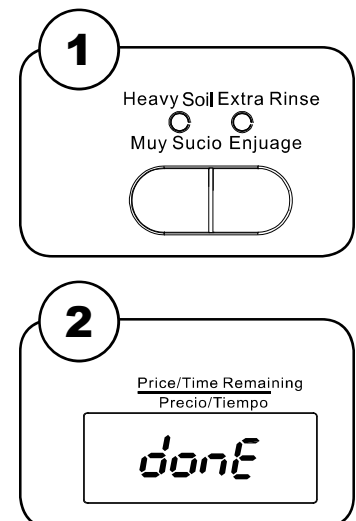



**Intentionally blank**

## Coin-Operated Machines

In coin-operated machines, prices for programs and options must be programmed during machine setup, and can be modified at any time. The machine must be set to COIN MODE.

Prices can be programmed as dollars and cents or as the number of coins or tokens required to start. There are four wash programs COLD, WARM, HOT, and DELICATE and two options HEAVY SOIL and EXTRA RINSE that can be programmed to the same or different prices. The option prices are added to the base prices of the COLD, WARM, and HOT programs. The options cannot be added to the DELICATE program.

## PRICE PROGRAMMING

1. To enter the programming mode unlock and remove the coin box.
2. Press and release the Service Switch located in the rear of the coin vault to enter service mode. The display will go blank.
3. Select one of the six program or option buttons for which the price is to be programmed. The current price for that selection is displayed.
4. Press the START button. The price will blink indicating it can be edited.
5. Use the four program selection buttons; COLD, WARM, HOT, and DELICATE to change each of the four digits in the price display. Each button increments a corresponding digit, left to right, in the price. Each digit rolls over from 9 to 0 without affecting the other digits. The left most digit cannot be programmed to "0", but can be blanked out completely.
6. When the desired price is displayed, press START. The display will stop blinking indicating the new value has been saved.
7. Repeat steps 3 through 6 for each remaining wash program and option. The option buttons only make adjustments to the basic programs, and are typically 0.25 or 0.50.
8. When all prices have been entered, press the Service Switch in the vault to exit service mode.
9. Check the newly entered prices by selecting each program without and with the option selections.

Register 26 ("No Decimal in Price") determines how prices are displayed by the machine. When set to "00" (default), prices are set and displayed with a decimal (e.g. "3.00"). When set to "01", the decimal point is turned off, and prices are set and displayed as "number of coins or tokens" required (e.g. "12"). In either case, the value of each coin drop is stored in Register 33 "Coin Value 1" and Register 34 "Coin Value 2" and determine how much the remaining price will be reduced each time a coin is deposited. The coin-value registers can be adjusted to accommodate any currency.

## DISCOUNT PRICE “PROMOTION” PROGRAMMING

The washer is capable of applying a “Promotion” percentage discount to the vend price of a program selection at specified times and days. Up to four different Promotion discount events and percentages can be selected using the washer’s built-in Real Time Clock (RTC) or one promotion event can be selected using an optionally-installed, external signal provided by a clock-driven relay or switch. This signal can activate multiple washers. Both options require setup via the service registers, access to which is described in the Service Mode section of this manual.

During machine setup, the promotional discount is represented by a two digit percentage (%) and can range from 0% (no discount) to “A0” = 100% (free wash). When Promotion pricing is active, the displayed vend price equals the sum of the discounted program price rounded up to the next multiple of register “033” (Coin value 1) and the option price, which is not discounted. For example, if Coin Value 1 = 0.25 and a 50% Promotion discount is applied to a COLD (1.00) wash program with a HEAVY SOIL (0.25) option selected (1.25 total), the displayed vend price would be rounded up to “0.75.”

To use Promotion percentage discount pricing the washer must be set to “COIN MODE” operation. Promotion pricing can be used with the washer set to either Decimal or No Decimal in price, Reg 26 = “00” or “01”.

### PROMOTION PRICING VIA THE REAL TIME CLOCK (RTC)

The RTC and Promotion pricing times are set and displayed in 24hr format. (e.g. 1:15 PM = 13:15). The promotion days of the week are represented by a two digit number (nn). The RTC’s built in calendar adjusts for leap years. Promotion pricing set up requires setting the RTC and up to four pairs of Promotional start and stop times and percentages.

#### RTC and Promotional Setup

1. Navigate to Register 70 (RTC set-up) as explained in the Service Mode section.
2. Press START, this will stop the clock. The year will be displayed as a four digit number (yyyy). Edit these values using the COLD, WARM, HOT, and DELICATE buttons.
3. Press START, a two day digit number “(0d)” for the day of the week will be displayed. (01=Sunday, 02=Monday, ... 07=Saturday.) Edit this value using the DELICATE button.
4. Press START, the Month and Day will be displayed as two digit numbers (mm.dd). Edit these values using the COLD, WARM, HOT, and DELICATE buttons.
5. Press START, the Hour and Minutes will be displayed in 24 hr format as two digit numbers (hh. mm). Edit these values using the COLD, WARM, HOT, and DELICATE buttons.
6. Press START to save the changes and exit register 70. This will reset the clock to the set time, reset the clock’s seconds digit to “00”, and restart the clock. This allows synchronizing the clocks on multiple machines to a master clock such as a wall clock, wristwatch, or cell phone.
7. Navigate to Register “71” (RTC Promotion #1 START) to set the percentage discount, day of the week and start time for promotion #1.

8. Press START, a two digit day number ("0d") for which the start day(s) of the week for promotion #1 will be displayed. (01=Sunday, 02=Monday, ...07=Saturday, 08=All days, 09=Monday-Friday only, 0A=Saturday and Sunday only, 00=promotion is inactive.) Edit this number using the DELICATE button to cycle through the allowed values.
9. Press START, the Hours and Minutes in 24 hr format for the start of Promotion #1 will be displayed (hh.mm). Edit these values using the COLD, WARM, HOT, and DELICATE buttons.
10. Press START, the promotion percentage discount will be displayed as two digits (%%).The discount can range from "00" = 0% to "A0" = 100% (e.g. Free Wash). Edit this number using the HOT and DELICATE buttons. Note, pressing the HOT button ten times will cycle the value to "A0".
11. Press START to save the changes and exit Register "71"
12. Navigate to Register "72" (RTC Promotion #1 END"). This will allow you to set the end time for promotion #1.
13. Press START, the promotion end time in hours and minutes in 24 hr format will be displayed (hh. min). Edit these values using the COLD, WARM, HOT, and DELICATE buttons.
14. Press START, this will save the changes and exit register 72.
15. Program the three other Promotion times and percentages as desired using register pairs: 073 & 074 (Promotion #2), 075 & 076 (Promotion #3), and 077 & 078 (Promotion #4). Each promotion can have a different percent reduction. They must not overlap with each other.
16. Exit Service Mode.

### PROMOTION PRICING VIA EXTERNAL CLOCK-DRIVEN RELAY OR SWITCH

This washer can apply a Promotion price discount using an external clock-driven relay or manual switch. To use this feature the washer requires an optional external price reduction harness kit be installed. Refer to the product installation manual for information regarding connecting this signal to the washer to activate discounts.

#### **External Signal and Promotional Firmware Setup**

1. Navigate to Register 79 (Promotion %% for discount input signal) as explained in the Service Mode section.
2. Press START the promotion percentage discount will be displayed as two digits (%%).The discount can range from "00" = 0% to "A0" = 100% (e.g. Free Wash). Edit this number using the HOT and DELICATE buttons. Note, pressing the HOT button ten times will cycle the value to "A0".
3. Press START, this will save the changes and exit register 79.
4. Exit Service Mode.

When the external signal is activated, the washer will apply a promotion percentage discount, set in register 79, to the displayed vend price.

Please contact Laundrylux's Technical Support team at (516) 371-0700 if you have any questions or need assistance with price programming or implementing discount price programming.

## Fault Codes

If power to the machine is accidentally cut, the machine will restart automatically when power is restored. The machine will resume the program it was running at the point the power was cut.

**Fig. 1** Faults/errors in the program or machine are indicated by a numerical error code on the panel display.

Some error codes are cleared automatically when the Start button is pressed to restart the machine and some when the door is opened.

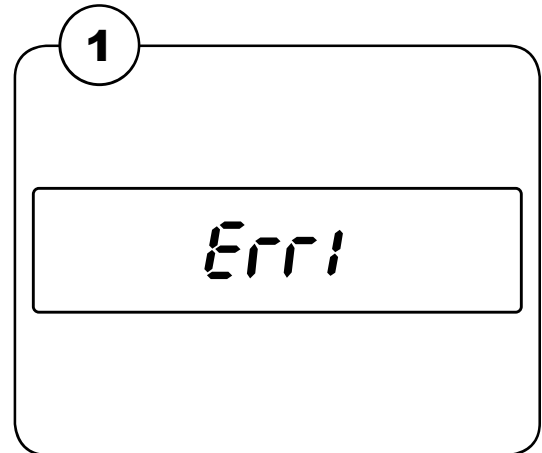

For the other error codes, a service technician must be called.

Error Code	Cause/Action
Er1A	Door fails to lock on wash program start.
Er1b	Doorlock error during wash program.
Er1C	Door fails to unlock at the end of wash program.
Er1d	Door switch opened during wash program. Make sure machine was not overloaded.
Er1E	INTERLOCK circuit failure (inverter).
Err2	Drain error. Water is not emptied in 10 minutes. Check pump strainer for clog.
Err5	Water level not reached within 8 minutes. Check water inlet screens for debris or clog.
Er7A	Motor overheat.
Er7b	No Tachometer signal. Motor harness disconnected.
Err8	Water Level above parameter set for safety during a wash program. Pump activates automatically.
Er10	Water level sensor error.
EuAr	Communication error between display and power modules.
Unb	Load cannot be balanced during extraction. Open door and manually rebalance clothes and press Start within two minutes.

The washer is capable of accepting payment using coins or tokens in COIN MODE or using payment cards in CARD MODE (serial). Setting the machine to COIN MODE and setting all wash program and option prices to "0.00" will allow the machine to operate for free in OPL mode.

### COIN OR SERIAL MODE CONFIGURATION

1. In Metered machines unlock and remove the coin box. Press and release the Service Switch located in the rear of the coin vault to enter service mode. In Non-Metered machines the Service Switch is located behind the front console locking plate.
2. The display will go blank.
3. Press the "HEAVY SOIL" and "EXTRA RINSE" buttons simultaneously. This display shows "0 00" if the machine is in COIN MODE or "1 00" if the machine is in CARD MODE.
4. Press the START button. The display flashes.
5. Press the COLD program button to change the operating mode. The left-most digit changes 0 → 1 or 1 → 0, indicating the new mode (0 = COIN=default, 1 = CARD).
6. Press the START button. The display stops flashing.
7. Press the service mode button to exit the service mode.
8. Disconnect and reconnect power.

The machine's software provides a "Service Mode" (SM) to adjust operating parameters and view usage statistics. The service mode also allows a technician to activate individual components of the machine, for troubleshooting. The software also provides a "Limited Service Mode" (LSM) that allows a technician to activate machine components, via PIN entry, without having access to the coin vault service switch. If desired on machine setup, LSM via PIN entry can be disabled or allowed to have full SM functionality without requiring access to the coin vault.

## **To activate Service Mode for machines with coin meters:**

1. Remove the coin box.
2. Press and release the SERVICE MODE plunger switch at the rear of the coin vault. The screen will display "8888".
3. Press the START button. "SE" appears in the display.
4. Use the HEAVY SOIL & EXTRA RINSE buttons to navigate to the desired register.
5. Press START to access the register or activate the function.
6. Use HEAVY SOIL & EXTRA RINSE to change values, as appropriate. Some registers require using the COLD, WARM, and HOT, DELICATE buttons to edit settings.
7. Press START to save new values, as appropriate.
8. Press the SERVICE MODE switch to exit. SM exits automatically after 60 seconds of inactivity with all service functions off.

For Non Metered machines, the SERVICE MODE plunger switch is located behind the front console locking plate.

## **To activate Limited Service Mode:**

1. Press and hold COLD, DELICATE, and START buttons for three seconds.
2. Use the program buttons to enter the PIN code (default is "1234").
3. Press START. The display shows "011" (the first register available in LSM).
4. Use the HEAVY SOIL & EXTRA RINSE buttons to navigate to the desired register.
5. Press START to access the register or activate the function.
6. Use HEAVY SOIL & EXTRA RINSE to change values, as appropriate.
7. Press START to save new values, as appropriate.
8. LSM exits automatically after 60 seconds of inactivity with all service functions off.

## **Service Mode Register Groups:**

00-19 Statistics: These are non-resettable auditing counters and log registers for tracking machine usage, the four latest errors, and the four latest coinbox opening time stamps.

20-39 Wash Program Parameters: These registers are used to adjust water levels and program structure.

40-59 Activate Machine Functions: In this group, the register address appears in the first two digits of the display, and the current setting appears in the right digit ("0" = deactivated, "1" = activated). Press the START button to toggle the state.

70-79 Real Time Clock, calendar, and time-of-day discount promotion setup: These registers set up the internal clock, calendar, and promotion pricing.

**STATISTICS (NON-RESETTABLE):**

- 000 - Cold program counter. Range: 0000 to F999, (A=10, ... F=15 e.g. "B101" = 11,101)
- 001 - Warm program counter. Range: 0000 to F999
- 002 - Hot program counter. Range: 0000 to F999
- 003 - Delicate program counter. Range: 0000 to F999
- 004 - Rinse and Spin program counter. Range 0000 to F999
- 005 - Heavy soil option (only) counter. Range: 0000 to F999
- 006 - Extra rinse option (only) counter. Range: 0000 to F999
- 007 - Heavy Soil & Extra Rinse counter both options selected Range: 0000 to F999
- 008 - Total program counter i.e. 00+01+02+03+04 . Range from 0000 to F999
- 009 - Coin totalizer - first 4 digits, from 0000 to 9999
- 010 - Coin totalizer - last 4 digits, from 00.00 - 99.99
- \*011 - Newest error and time stamp. "011">E ##>yyyy>mm.dd>hh.mm>(reg 8)>"010"
- \*012 - 2nd latest error and time stamp.
- \*013 - 3rd latest error and time stamp.
- \*014 - Oldest error and time stamp. "014">E ##>yyyy>mm.dd>hh.mm>(reg 8)>"010"
- 015 - Coin box access 1 time stamp: (Most recent access)
- 016 - Coin box access 2 time stamp:
- 017 - Coin box access 3 time stamp:
- 018 - Coin box access 4 time stamp: (Oldest access).
- \*019 - Firmware version.

**Statistics (000-010):** Program and option counts are updated when the cycle ends. When in coin mode (decimal in price), registers 009-010 shows the value of the amount collected. When in no-decimal mode (token), 009-010 shows the number of coins collected. When both program options have been selected for a program, register 007 is incremented but not registers 005 and 006.

**Error Codes (011-014):** Selecting an error register displays the error code. Each successive press of the START button (>) advances the display: Year > Month.Day > Hour.Minutes > Total Program Count > Register Exit. As new errors occur, they are saved in register 011 and the older records shift up by one register location. The original contents of register 014 are discarded.

**Coin Box Access (015-018):** Each successive press of the START button (>) advances the display: Year > Month.Day> Hour.Minutes> Register Exit. With each opening of the coin box, the register time stamps are saved in register 015 and the older records shift up by one register location. The original contents of register 018 are discarded.

**Wash Program Parameters:**

- 020 - Low water level (prewash & wash): range 5-32 (Approximate volume in liters, default = 07").
- 021 - High water level (rinse): range 5-32 (Approximate volume in liters, default = 10").
- 022 - Delete rinse 2: range "00" or "01", default="01" (rinse 2 deleted).
- 023 - Delete prewash: range "00" or "01", default="01" (prewash deleted).
- 024 - Default program selection:
  - 00= No cycle selected (display "----"). Enables RINSE&SPIN program selection.
  - 01= COLD cycle is default (This is the factory default)
  - 02= WARM cycle is default
  - 03= HOT cycle is default
  - 04= DELICATE cycle is default.



- 025 - Mainwash time: from 0-999 seconds, default="360", i.e. six minutes.
- 026 - Decimal in price: "00"= default=decimal displayed, "01"= no decimal (token).
- 027 - Silence buzzer: Range: "00"=default=enabled, "01" = disabled.
- 028 - Regret Time: The allowable time, after program start, that a user can change the wash program/options or add items to the wash. 0000-9999 seconds. "0000" = disabled, Default = 030. "9999" = unrestricted.

Press the START button, to pause the cycle and unlock door. If the new program/option selection has a higher vend value, the user will be prompted to insert additional payment. Upon pressing the start button with the door closed, the door will relock and the cycle resumes.

- 030 - COLD cycle maximum final extract speed RPM: ("0700" or "1000"=default)
- 031 - WARM cycle maximum final extract speed RPM: ("0700" or "1000"=default)
- 032 - HOT cycle maximum final extract speed RPM: ("0700" or "1000"=default)
- 033 - Coin value 1: "0000-9999", default = "0025"
- 034 - Coin value 2: "0000-9999", default = "0100"
- 035 - Limited Service Mode PIN setting: Default = "1234". ("0000" disables LSM).
- 036 - Full Service Mode via PIN entry setting: Default = '0000" (Disabled).
- 037 - Network address: "0000 - 9999", "0000"= default

### **Activate Machine Functions (door closed):**

- \*040 - Door lock.
- \*041 - Cold water - detergent compartment (Y11).
- \*042 - Warm water - detergent compartment (Y11 + Y13).
- \*043 - Hot water - detergent compartment (Y13).
- \*044 - Cold water - bleach compartment (Y21).
- \*045 - Cold water, softener compartment (Y11 + Y21).
- \*046 - Drain pump.
- \*047 - Drum clockwise wash rotation, 50 RPM.
- \*048 - Drum counter-clockwise wash rotation, 50 RPM.
- \*049 - Drum clockwise distribution rotation, 95 RPM.
- \*050 - Drum counter-clockwise distribution rotation, 95 RPM.
- \*051 - Drum 400 RPM.
- \*052 - Drum 600 RPM.
- \*053 - Drum 1000 RPM.
- \*054 - Display test.

- \*055 - Buzzer test.
- \*056 - Detergent pump trigger signal.
- \*057 - Bleach pump trigger signal.
- \*058 - Softener pump trigger signal.
- \*059 - Coin meter test, each dropped coin adds 1 to displayed total. Registers 009 and 010 unaffected.

### Real Time Clock (RTC), Calendar and Time-of-day Discount Promotion.

- 070 - RTC set-up: 24hr format, "070">yyyy>mm.dd>hh.mm>"070". During set up, the RTC is stopped. When the "START" button is pressed to save hh.mm and exit register 70, the seconds digits of the RTC is set to "00" without affecting the hours and minutes values, and the RTC re-started.
- 071 - RTC promotion 1 START: "071">D>hh.mm>%%>"071"
- 072 - RTC promotion 1 END: "072">hh.mm>"072"
- 073 - RTC promotion 2 START "073">D>hh.mm>%%>"073"
- 074 - RTC promotion 2 END "074">hh.mm>"074"
- 075 - RTC promotion 3 START "075">D>hh.mm>%%>"075"
- 076 - RTC promotion 3 END "076">hh.mm>"076"
- 077 - RTC promotion 4 START "077">D>hh.mm>%%>"077"
- 078 - RTC promotion 4 END "078">hh.mm>"078"
- 079 - Promotion %% for discount input signal (range "00"-"A0", default="00", "A0" = 100%)

Select a value identifying the day(s) "D" for which the promotion will be active, as follows:

- 00=promotion is inactive.
- 01=Sunday, 02=Monday, ...07=Saturday.
- 08=All days, 09=Monday-Friday only, 0A=Saturday and Sunday only.

Use COLD, WARM, HOT, & DELICATE to edit "yyyy", "mm.dd", & "hr.min" values. Press START to advance to the next entry within the register.

Use HOT and DELICATE to edit the discount percentage "%%". If percentage = 90-99 pressing DELICATE will set the percentage to "A0" = 100%.

Note:

\* = Registers can be accessed in Limited Service Mode.

Resetting the display controller will restore all applicable firmware settings to factory default. The machine will be set to COIN MODE with all wash program and option prices = 0.00.

To keep your machine in proper working order, follow the preventive maintenance recommendations provided below.

The maintenance interval should be adjusted according to machine usage.

Leave the loading door open when the machine is not in use.

## Daily

- Check the door and door lock:
  - Open the door and try starting the machine. The machine **MUST NOT START**.
  - Close the door, start the machine and try opening the door using reasonable force. **IT MUST NOT BE POSSIBLE TO OPEN THE DOOR WHILE THE MACHINE IS OPERATING!**
  - Check that the door does not leak.
  - Clean the door seal, removing any detergent and lint.
- Check that there are no indications of leaks behind or around the machine.
- Clean out any residue remaining in the detergent dispenser.
- Use a soft wash cloth and mild detergent to clean door and plastic panels.
- Inspect liquid chemical tubing and connections for leaks. Repair as necessary.

## Every Third Month (refer this service to qualified personnel)



- Check the drain pump strainer and remove any accumulated lint and debris.
- Inspect the interior of the machine (during an actual wash cycle to ensure that no leaks are noticed) by:
  - Turning off the main power switch of the machine.
  - Remove the top panel.
  - Start a wash program.
  - **KEEP CLEAR OF MOVING PARTS WHILE MACHINE IS OPERATING!!**
  - Inspect all internal hoses, seals and gaskets for signs of leakage.  
Repair as necessary.
  - Stop the machine and disconnect the power. Turn off the water supply and check that the water inlet screens are clear of debris. Dirty screens result in longer fill times, reducing productivity.
  - Inspect the drive belt. Adjust the tension or replace as necessary.
  - Check that there are no signs of leakage on the floor beneath the machine. Locate and repair any leak.

Contact your local dealer, or Laundrylux Technical Support at (516) 371-0700 if you have questions regarding installation, operation, or maintenance of your machine.

# Wash Programs

## COLD

Agitation 12 sec on / 3 sec off

## COLD

PROGRAM	NO OPTION	HEAVY SOIL	EXTRA RINSE	HEAVY SOIL EXTRA RINSE
<b>PreRinse</b>	---	2 min C low	---	2 min C low
<b>Drain</b>	---	Y	---	Y
<b>Prewash</b>	3 min C low	3 min C low	3 min C low	3 min C low
<b>Drain</b>	Y	Y	Y	Y
<b>Mainwash</b>	6 min C low	6 min C low	6 min C low	6 min C low
<b>Drain</b>	Y	Y	Y	Y
<b>Rinse 1</b>	1 min C high	1 min C high	1 min C high	1 min C high
<b>Drain</b>	Y	Y	Y	Y
<b>Spin</b>	30 sec / 400RPM	30 sec / 400RPM	30 sec / 400RPM	30 sec / 400RPM
<b>Rinse 2</b>	1 min C high	1 min C high	1 min C high	1 min C high
<b>Drain</b>	Y	Y	Y	Y
<b>Spin</b>	30 sec / 400RPM	30 sec / 400RPM	30 sec / 400RPM	30 sec / 400RPM
<b>Rinse 3</b>	---	---	1 min C high	1 min C high
<b>Drain</b>	---	---	Y	Y
<b>Spin</b>	30 sec / 400RPM	30 sec / 400RPM	30 sec / 400RPM	30 sec / 400RPM
<b>Rinse Soft</b>	2 min C high	2 min C high	2 min C high	2 min C high
<b>Drain</b>	Y	Y	Y	Y
<b>Spin</b>	6 min	6 min	6 min	6 min

**NOTES:**

All segment times are measured from completion of fill.

C = COLD valve open

H = HOT valve open

CH = COLD and HOT valves open

low = LOW level

high = HIGH level

Y = Yes

# Wash Programs

## WARM

Agitation 12 sec on / 3 sec off

## WARM

PROGRAM	NO OPTION	HEAVY SOIL	EXTRA RINSE	HEAVY SOIL EXTRA RINSE
PreRinse	---	2 min CH low	---	2 min CH low
Drain	---	Y	---	Y
Prewash	3 min CH low	3 min CH low	3 min CH low	3 min CH low
Drain	Y	Y	Y	Y
Mainwash	6 min CH low	6 min CH low	6 min CH low	6 min CH low
Drain	Y	Y	Y	Y
Rinse 1	1 min C high	1 min C high	1 min C high	1 min C high
Drain	Y	Y	Y	Y
Spin	30 sec / 400RPM	30 sec / 400RPM	30 sec / 400RPM	30 sec / 400RPM
Rinse 2	1 min C high	1 min C high	1 min C high	1 min C high
Drain	Y	Y	Y	Y
Spin	30 sec / 400RPM	30 sec / 400RPM	30 sec / 400RPM	30 sec / 400RPM
Rinse 3	---	---	1 min C high	1 min C high
Drain	---	---	Y	Y
Spin	30 sec / 400RPM	30 sec / 400RPM	30 sec / 400RPM	30 sec / 400RPM
Rinse Soft	2 min C high	2 min C high	2 min C high	2 min C high
Drain	Y	Y	Y	Y
Spin	6 min	6 min	6 min	6 min

### NOTES:

All segment times are measured from completion of fill.

C = COLD valve open

H = HOT valve open

CH = COLD and HOT valves open

low = LOW level

high = HIGH level

Y = Yes

## Wash Programs

### HOT

Agitation 12 sec on / 3 sec off

### HOT

PROGRAM	NO OPTION	HEAVY SOIL	EXTRA RINSE	HEAVY SOIL EXTRA RINSE
<b>PreRinse</b>	---	2 min CH low	---	2 min CH low
<b>Drain</b>	---	Y	---	Y
<b>Prewash</b>	3 min CH low	3 min CH low	3 min CH low	3 min CH low
<b>Drain</b>	Y	Y	Y	Y
<b>Mainwash</b>	6 min H low	6 min H low	6 min H low	6 min H low
<b>Drain</b>	Y	Y	Y	Y
<b>Rinse 1</b>	1 min CH high	1 min CH high	1 min CH high	1 min CH high
<b>Drain</b>	Y	Y	Y	Y
<b>Spin</b>	30 sec / 400RPM	30 sec / 400RPM	30 sec / 400RPM	30 sec / 400RPM
<b>Rinse 2</b>	1 min C high	1 min C high	1 min C high	1 min C high
<b>Drain</b>	Y	Y	Y	Y
<b>Spin</b>	30 sec / 400RPM	30 sec / 400RPM	30 sec / 400RPM	30 sec / 400RPM
<b>Rinse 3</b>	---	---	1 min C high	1 min C high
<b>Drain</b>	---	---	Y	Y
<b>Spin</b>	30 sec / 400RPM	30 sec / 400RPM	30 sec / 400RPM	30 sec / 400RPM
<b>Rinse Soft</b>	2 min C high	2 min C high	2 min C high	2 min C high
<b>Drain</b>	Y	Y	Y	Y
<b>Spin</b>	6 min	6 min	6 min	6 min

**NOTES:**

All segment times are measured from completion of fill.

C = COLD valve open

H = HOT valve open

CH = COLD and HOT valves open

low = LOW level

high = HIGH level

Y = Yes

# Wash Programs

## DELICATE

Agitation 4 sec on / 12 sec off

## DELICATE

PROGRAM	NO OPTION	HEAVY SOIL	EXTRA RINSE	HEAVY SOIL EXTRA RINSE
PreRinse	---	Not Available	Not Available	Not Available
Drain	---	(DOUBLE BEEP)	(DOUBLE BEEP)	(DOUBLE BEEP)
Prewash	---			
Drain	---			
Mainwash	4 min C			
Drain	Y			
Rinse 1	1 min C high			
Drain	Y			
Spin	30 sec / 400RPM			
Rinse 2	1 min C high			
Drain	Y			
Spin	30 sec / 400RPM			
Rinse 3	---			
Drain	---			
Spin	30 sec / 400RPM			
Rinse Soft	2 min C high			
Drain	Y			
Spin	2 min			

### NOTES:

All segment times are measured from completion of fill.

C = COLD valve open

H = HOT valve open

CH = COLD and HOT valves open

low = LOW level

high = HIGH level

Y = Yes

# Wash Programs

## RINSE AND SPIN

Agitation 12 sec on / 3 sec off

### RINSE AND SPIN\*

PROGRAM	NO OPTION	HEAVY SOIL	EXTRA RINSE	HEAVY SOIL EXTRA RINSE
PreRinse			---	
Drain			---	
Prewash			---	
Drain			---	
Mainwash			---	
Drain			---	
Rinse 1			4 min C	
Drain			Y	
Spin			---	
Rinse 2			---	
Drain			---	
Spin			---	
Rinse 3			---	
Drain			---	
Spin			---	
Rinse Soft			---	
Drain			---	
Spin			6 min	

**NOTES:**

\*Register 24 = "00", No wash programs selected.

All segment times are measured from completion of fill.

C = COLD valve open

H = HOT valve open

CH = COLD and HOT valves open

low = LOW level

high = HIGH level

Y = Yes



# Laundrylux

Sales and Administration: (516) 371-4400  
Spare Parts: (516) 371-2000  
Technical Support: (516) 371-0700  
En Mexico: 001-800-010-1010  
461 Doughty Blvd., Inwood, NY 11096

**[laundrylux.com](http://laundrylux.com)**