

Café™ 36" Panel-Ready Integrated Bottom-Freezer Refrigerator, Right Swing

CIC36RK6ZII

C A F É

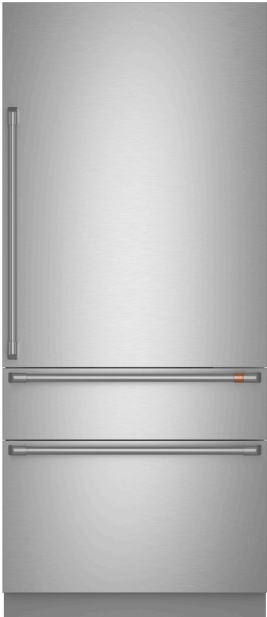

Panels and handles are sold separately.

Panel-Ready Refrigerator

This panel-ready refrigerator allows you to add a custom panel to achieve a seamless look that matches your kitchen cabinetry

Bright LED Lighting

Easily find even the smallest items thanks to flush-mounted refrigerator LED lights, designed to shed crisp, even light throughout the interior

Stylish Interior with Adjustable Door Bins

Complement your kitchen's aesthetic with a stylish refrigerator that offers sophisticated yet functional details throughout the interior

Advanced Ice Filtration

Enjoy filtered ice thanks to an included, advanced filter that reduces 50+ impurities including lead, chlorine, microplastics, and PFOA/PFOS (replacement filter sold separately)

Sabbath Mode

This refrigerator with Sabbath mode is designed to disable functions in accordance with Sabbath-observing practices

Articulating Hinges + True Flush Installation

With a true flush inset installation and hidden articulating hinges, this integrated refrigerator blends in with surrounding cabinetry for a stylish kitchen aesthetic

4-Temperature Convertible Climate Drawer

Experience the full flexibility of a temperature controlled drawer that offers 4 pre-set customizable options: Meat, Drinks, Snacks, and a Full Freeze setting

Advanced Temperature Control

Create the perfect environment for a variety of foods with a temperature management system that maintains consistency in each refrigerator zone and provides an accurate display

Factory-Installed Icemaker

Included icemaker ensures you always have a steady supply of ice on hand

Stainless Steel Finish Option

Add on the fully integrated stainless door panel kit and choose from 6 different Café handle finishes for a stainless steel look



Café™ 36" Panel-Ready Integrated Bottom-Freezer Refrigerator, Right Swing



CIC36RK6ZII

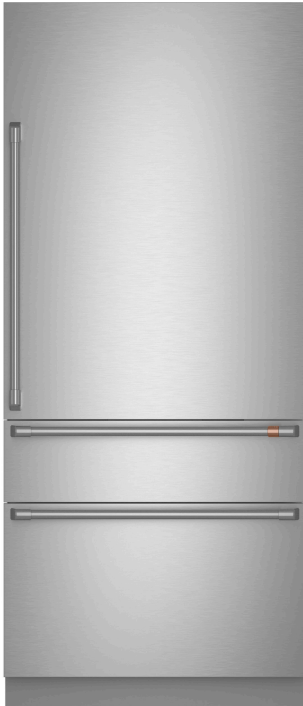

Panels and handles are sold separately.

OVERALL DIMENSIONS

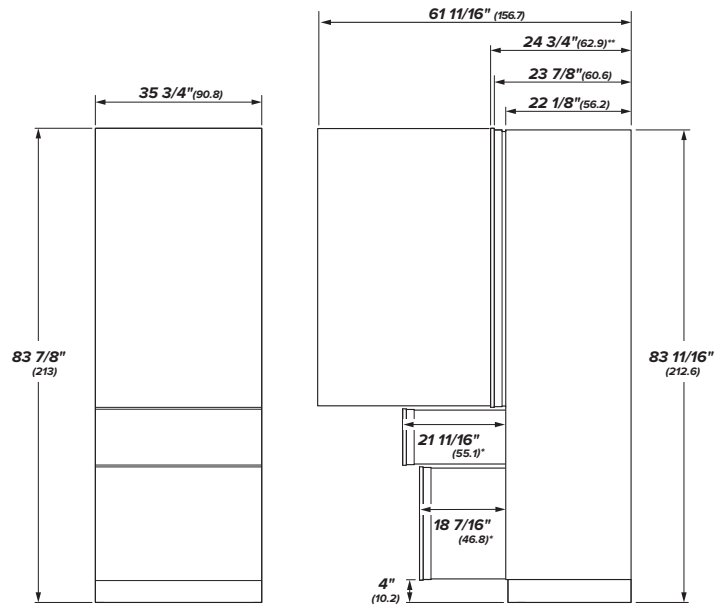

FRONT VIEW

SIDE VIEW

*Depth dimension without handle.
Cafe handle adds 2 9/16" depth.
**Includes 3/4" door panel

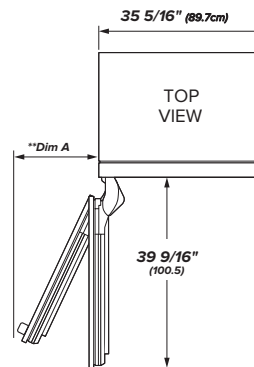

Door Angle	Dim A	
	Door	Handle
90°	2 3/16" (5.6)	6 3/4" (17.1)
115°	17 11/16" (44.9)	21 9/16" (54.8)

**Dimensions based on Cafe handle height of 2 9/16" (6.5) and a hand clearance of 2" (5.1).

SPECIFICATIONS

Overall Width	35 3/4" (90.8 cm)
Overall Height	83 7/8" (213 cm)
Overall Depth	24 3/4" (62.9 cm)
Door Clearance	see TOP VIEW **Dim A
Cutout Width	36" (91.4 cm)
Cutout Height	84" (213.4 cm)
Cutout Depth	25" (63.5 cm)
Net Weight (approx)	550 lbs (250 kg)

ATTENTION ELECTRICIAN:

A 115 volt 60Hz., 15 or 20 amp power supply is required. An individual properly grounded branch circuit or circuit breaker is recommended. For multiple unit installation, each unit requires separate individually properly grounded circuit or breaker and separate properly grounded 3-prong electrical receptacle recessed.

WARNING:

When installing appliance, you must use and follow the product installation instructions. These can be found with unit or on web at cafeappliances.com.

WARRANTY:

Labor Warranty	Limited 1-year entire appliance Limited 5-year sealed refrigerating system
Parts Warranty	Limited 1-year entire appliance Limited 5-year sealed refrigerating system

Dimensions in parentheses are in centimeters unless otherwise noted. Actual product dimensions may vary due to manufacturing tolerances



Café™ 36" Panel-Ready Integrated Bottom-Freezer Refrigerator, Right Swing



CIC36RK6ZII

SINGLE INSTALLATION

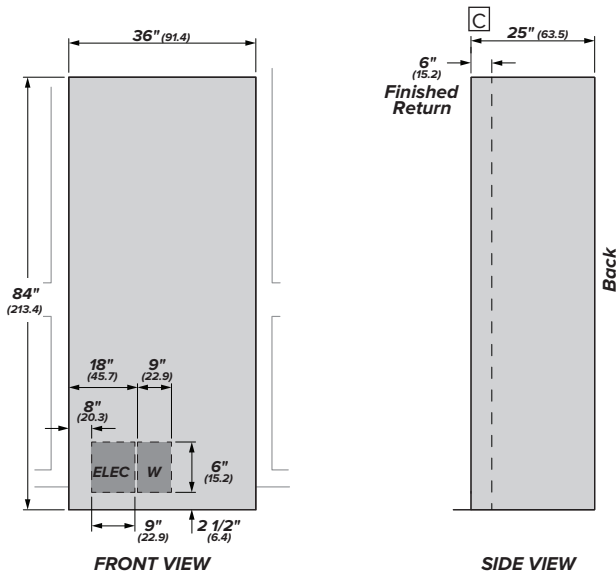

FLUSH 3/4" PANEL DIMENSIONS SINGLE INSTALLATION

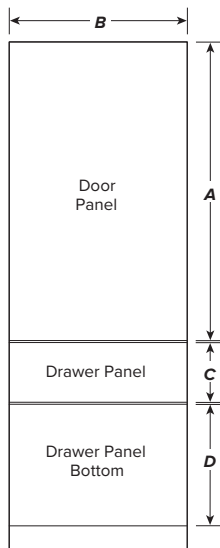

PANEL DIMENSIONS

A	B	C	D
49 3/8"	35 3/4"	9 11/16"	20 9/16"

INTEGRATED INSTALLATION

HELPFUL TIPS

- C A minimum 6" (15.2) finished return matching cabinet exterior recommended on interior on all sides and top at front of opening
- Trimmed refrigerators are designed to be customized with decorative panels. Field-installed 3/4" custom door panels are required.
- Maximum total panel weight:
 Fresh Food Door - 39.2 lbs.
 Convertible Drawer - 7.6 lbs.
 Freezer Drawer - 17.2 lbs.
 Note: For panels constructed with rails and stiles (5-panel), the rails and stiles must be a minimum of 2" (5.08cm) wide.
- For Custom Panels: Use templates provided with units to pre-drill holes for mounting panel brackets (provided with unit). Adjustment screws and instructions also provided with units. Custom panels require a custom handle from a cabinetmaker.
- Stainless steel panel and handle options:
 ZK3SN364WRH: Right-hand Single Door Bottom Freezer Stainless Steel door panel kit
 CXSB3H3PZSS: Brushed Stainless handle kit
 CXSB3H3PVBZ: Brushed Bronze handle kit
 CXSB3H3PVCG: Brushed Brass handle kit
 CXSB3H3PVCU: Brushed Copper handle kit
 CXSB3H3PVBT: Brushed Black handle kit
 CXSB3H3PVFB: Flat Black handle kit
- GE SmartConnect® Refrigerator Tubing Kits:
 The only Café-approved plastic tubing is supplied in the SmartConnect Refrigerator Tubing kits.
 WX08X10006: Water Line 8' (2.5m)
 WX08X10015: Water Line 15' (4.6m)
 WX08X10025: Water Line 25' (7.6m)

⚠ WARNING:

When installing appliance, you must use and follow the product installation instructions. These can be found with unit or on web at cafeappliances.com



Café™ 36" Panel-Ready Integrated Bottom-Freezer Refrigerator, Right Swing



CIC36RK6ZII

DUAL INSTALLATION

36" INTEGRATED BOTTOM FREEZER (LEFT-HAND DOOR SWING), CIC36LK6ZII
 36" INTEGRATED BOTTOM FREEZER (RIGHT-HAND DOOR SWING), CIC36RK6ZII

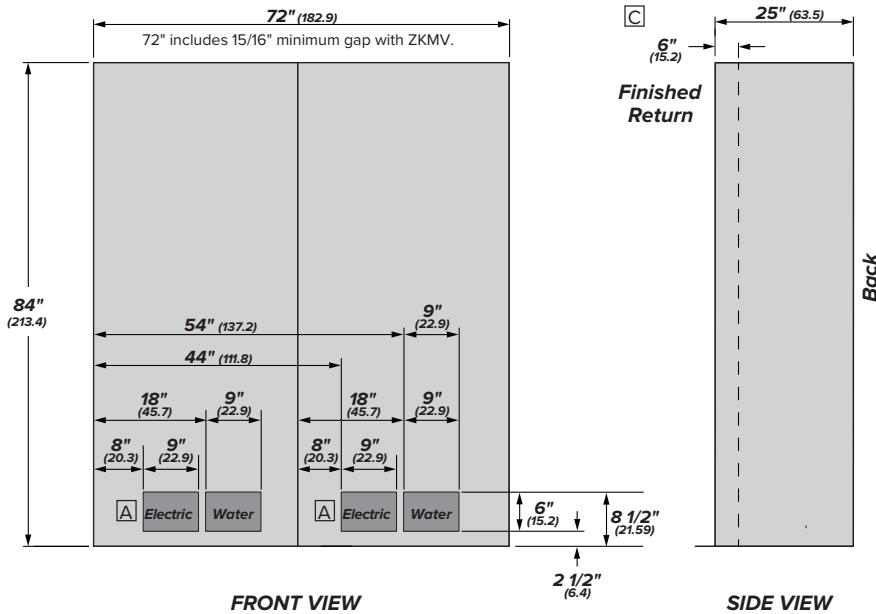

INTEGRATED INSTALLATION

HELPFUL TIPS

- A** A separate 115V, 60Hz, 15- or 20-amp power supply is recommended for each product
- B** Cutout based on installation of two products with a left- and right-hand door swing
- C** A minimum 6" (15.2) finished return matching cabinet exterior recommended on interior on all sides and top at front of opening

ZKMV Unification kit is required for all dual installations with this product.

DUAL PRODUCT CLEARANCES

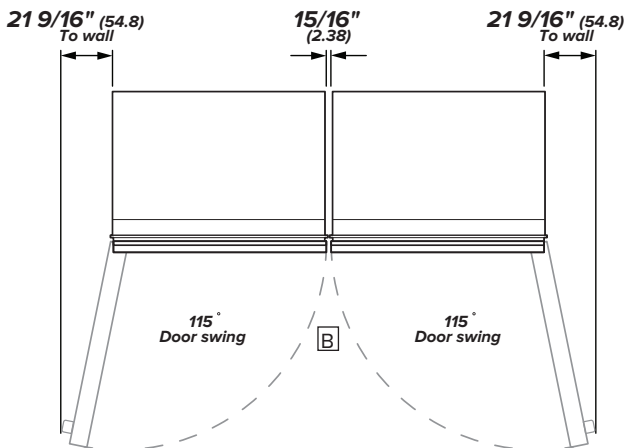

**Dimensions based on Café Handle height of 2 9/16" (6.5) and a hand clearance of 2" (5.1).

In a side-by-side installation of a left- and right-hand door swing product, 15/16" clearance between the units is required, in addition to the side-by-side unification/heater kit, ZKMV.



Café™ 36" Panel-Ready Integrated Bottom-Freezer Refrigerator, Right Swing

CIC36RK6ZII

CAFÉ

FLUSH 3/4" PANEL DIMENSIONS DUAL INSTALLATION

36" INTEGRATED BOTTOM FREEZER (LEFT-HAND DOOR SWING), CIC36LK6ZII
 36" INTEGRATED BOTTOM FREEZER (RIGHT-HAND DOOR SWING), CIC36RK6ZII

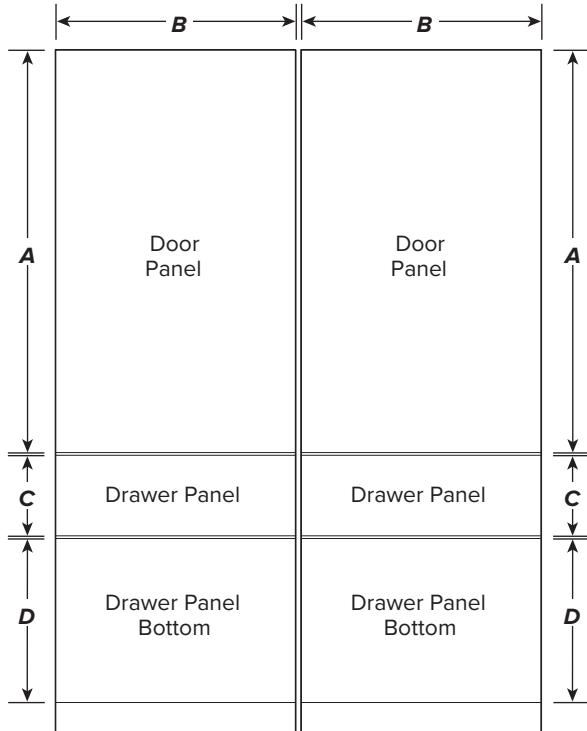

PANEL DIMENSIONS

A	B	C	D
49 3/8"	35 13/16"	9 11/16"	20 9/16"

INTEGRATED INSTALLATION

HELPFUL TIPS

- Trimmed refrigerators are designed to be customized with decorative panels. Field-installed 3/4" custom door panels are required.
- Maximum total panel weight:
 Fresh Food Door - 39.2 lbs.
 Convertible Drawer - 7.6 lbs.
 Freezer Drawer - 17.2 lbs.
 Note: For panels constructed with rails and stiles (5-panel), the rails and stiles must be a minimum of 2" (5.08cm) wide.
- For Custom Panels: Use templates provided with units to pre-drill holes for mounting panel brackets (provided with unit). Adjustment screws and instructions also provided with units. Custom panels require a custom handle from a cabinetmaker.
- Stainless steel handle and panel options:
 ZK3SN364WRH: Right-hand single door bottom freezer stainless steel door panel kit
 ZK3SN369WLH: Left-hand single door bottom freezer stainless steel door panel kit
 CXSB3H3PZSS: Brushed Stainless handle kit
 CXSB3H3PVBZ: Brushed Bronze handle kit
 CXSB3H3PVCG: Brushed Brass handle kit
 CXSB3H3PVCU: Brushed Copper handle kit
 CXSB3H3PVBT: Brushed Black handle kit
 CXSB3H3PVFB: Flat Black handle kit
- Dual installation accessory kits:
 ZKN72V: 72" stainless full-width toekick
 ZKMV: Integrated bottom-freezer unification/heater kit



Café™ 36" Panel-Ready Integrated Bottom-Freezer Refrigerator, Right Swing



CIC36RK6ZII

SINGLE INSTALLATION

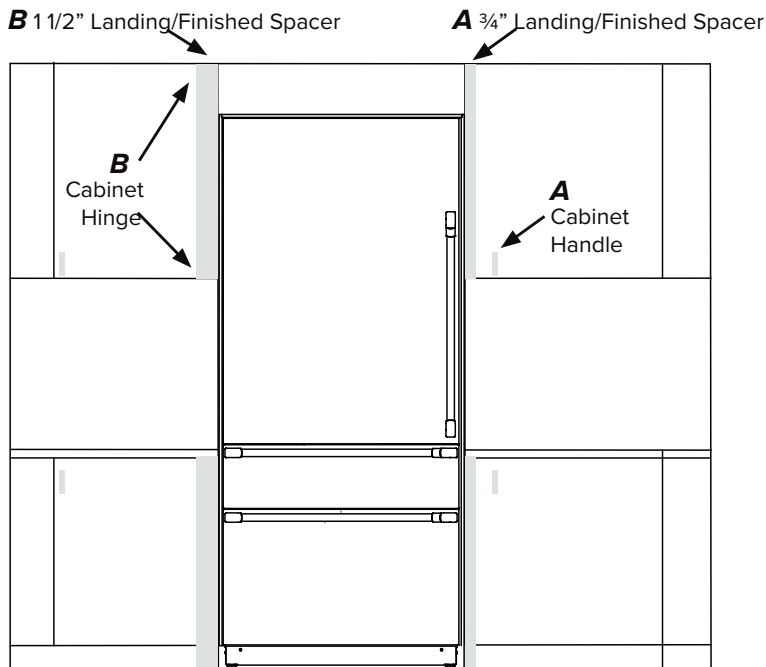
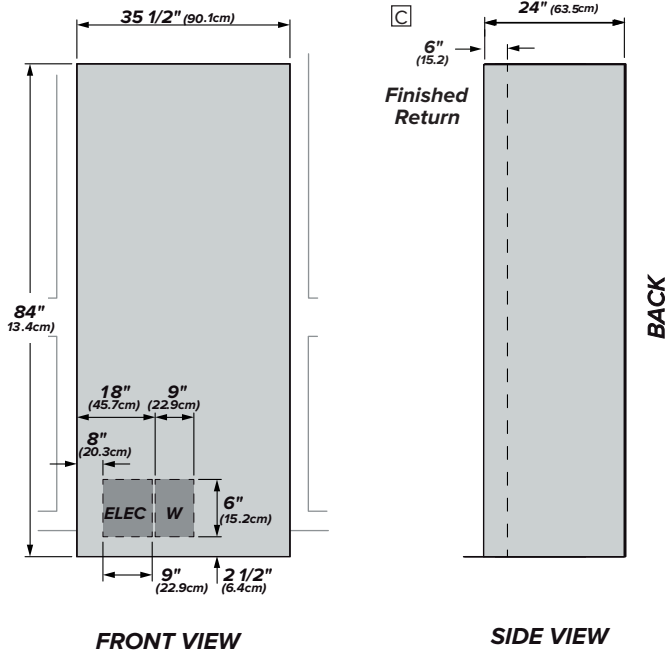

NOTE: GFI (ground fault interrupter) is not recommended. Water line can enter the opening through the floor or rear wall. The water line installed should be 1/4" O.D. copper tubing or GE SmartConnect™ tubing between the cold water line and water connection location. The line should be long enough to extend to the front of the refrigerator. Installation of an easily accessible shutoff valve in the water line is required.

STANDARD INSTALLATION

HELPFUL TIPS

☐ A minimum 6" (15.2) finished return matching cabinet exterior recommended on interior on all sides and top at front of opening

- Stainless steel panel and handle options:
 - ZK3SN364WRH: Right-hand Single Door Bottom Freezer Stainless Steel door panel kit
 - CXSB3H3PZSS: Brushed Stainless handle kit
 - CXSB3H3PVBZ: Brushed Bronze handle kit
 - CXSB3H3PVCG: Brushed Brass handle kit
 - CXSB3H3PVCU: Brushed Copper handle kit
 - CXSB3H3PVBT: Brushed Black handle kit
 - CXSB3H3PVFB: Flat Black handle kit

- Single installation accessory kit:
 - ZKW36V: Single installation retrofit/standard installation (required when installing in a 35 1/2" wide and 24" deep cutout)
 - *Product at Standard trim is 37" (94cm) wide, 28 15/16" (73.5cm) deep (with handles), and 84 1/2" (214.6cm) height.

- Minimum Clearance Dimensions with Trims Installed:
 - 3/4" landing needed for cabinetry door/drawer edge adjacent with hinge opposite of cutout
 - 1 1/2" landing needed for cabinetry door/drawer with hinge adjacent to cutout

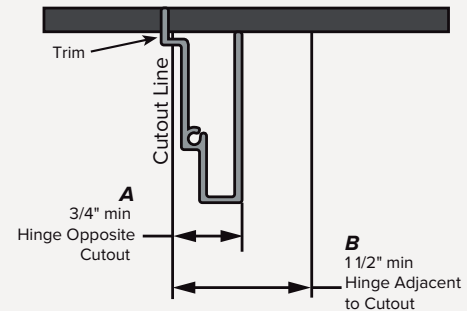

A. Option clearance Cabinet Handle next to trim. 3/4" Minimum landing clearance (matching cabinet finish) needed from cutout opening for Standard Trim.

B. Option clearance Cabinet hinge next to trim. 1 1/2" Minimum landing clearance (matching cabinet finish) needed from cutout opening for Standard Trim to clear cabinetry door hinges.

- GE SmartConnect® Refrigerator Tubing Kits:
 - The only Café-approved plastic tubing is supplied in the SmartConnect Refrigerator Tubing kits.
 - WX08X10006: Water Line 8' (2.5m)
 - WX08X10015: Water Line 15' (4.6m)
 - WX08X10025: Water Line 25' (7.6m)

⚠ WARNING:

When installing appliance, you must use and follow the product installation instructions. These can be found with unit or on web at cafeappliances.com



Café™ 36" Panel-Ready Integrated Bottom-Freezer Refrigerator, Right Swing



CIC36RK6ZII

DUAL INSTALLATION

- 36" INTEGRATED BOTTOM FREEZER (LEFT-HAND DOOR SWING), CIC36LK6ZII
- 36" INTEGRATED BOTTOM FREEZER (RIGHT-HAND DOOR SWING), CIC36RK6ZII

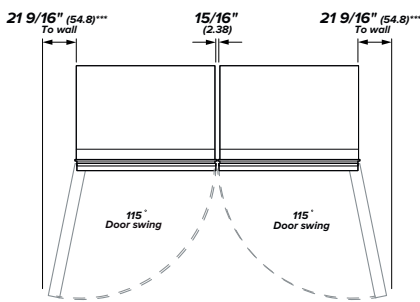
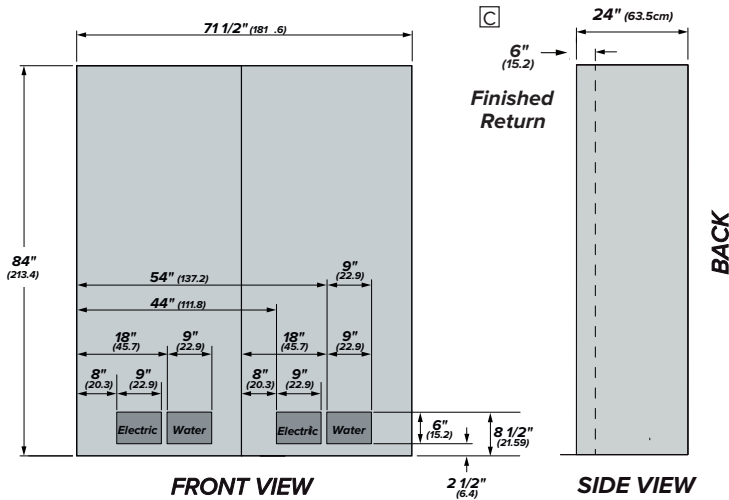

***Dimension based on Cafe handle height of 2 9/16" (6.5)

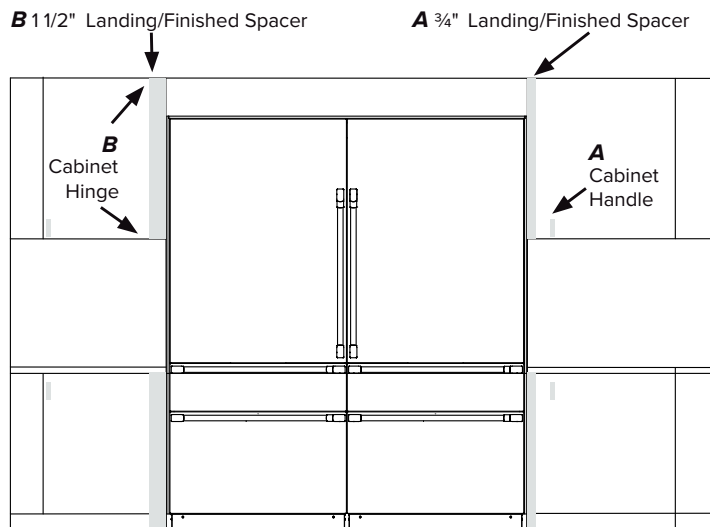

STANDARD INSTALLATION

HELPFUL TIPS

C A minimum 6" (15.2) finished return matching cabinet exterior recommended on interior on all sides and top at front of opening

- Stainless steel panel and handle options:
 - ZK3SN364WRH: Right-hand single door bottom freezer stainless steel door panel kit
 - ZK3SN369WLH: Left-hand single door bottom freezer stainless steel door panel kit
 - CXSB3H3PZSS: Brushed Stainless handle kit
 - CXSB3H3PVBZ: Brushed Bronze handle kit
 - CXSB3H3PVCG: Brushed Brass handle kit
 - CXSB3H3PVCU: Brushed Copper handle kit
 - CXSB3H3PVBT: Brushed Black handle kit
 - CXSB3H3PVFB: Flat Black handle kit

- Dual installation accessory kits:
 - ZKW72V: Standard dual installation kit (required when installing in a 71 1/2" wide and 24" deep cutout)
 - ZKK72R: 71 1/2" stainless full-width toe-kick
 - ZKMV: Integrated bottom-freezer unification/heater kit

*Product at Standard dual-install trim is 72 15/16" (185.2cm) wide, 28 15/16" (73.5cm) deep (with handles), and 84 1/2" (214.6cm) height.

- Minimum Clearance Dimensions with Trims Installed:
 - 3/4" landing needed for cabinetry door/drawer edge adjacent with hinge opposite of cutout
 - 1 1/2" landing needed for cabinetry door/drawer with hinge adjacent to cutout

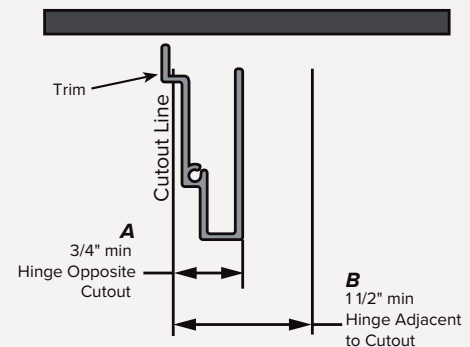

A. Option clearance Cabinet Handle next to trim. 3/4" Minimum landing clearance (matching cabinet finish) needed from cutout opening for Standard Trim.

B. Option clearance Cabinet hinge next to trim. 1 1/2" Minimum landing clearance (matching cabinet finish) needed from cutout opening for Standard Trim to clear cabinetry door hinges.

- GE SmartConnect™ Refrigerator Tubing Kits:
 - The only Café-approved plastic tubing is supplied in the SmartConnect Refrigerator Tubing kits.
 - WX08X10006: Water Line 8' (2.5m)
 - WX08X10015: Water Line 15' (4.6m)
 - WX08X10025: Water Line 25' (7.6m)

⚠ WARNING:

When installing appliance, you must use and follow the product installation instructions. These can be found with unit or on web at cafeappliances.com

