

# CVIU338RX



<b>Product Family</b>	Wine cooler
<b>Installation</b>	Built-in
<b>Built-In Niche</b>	82-87 cm
<b>Defrost</b>	Automatic
<b>Cooling type</b>	Fan-assisted
<b>Hinge type</b>	Standard
<b>Hinge position</b>	Right-hand



## Wine compartment features



<b>Number of fixed shelves</b>	2
<b>Number of removable shelves</b>	3
<b>Shelves material</b>	Wood
<b>Removable shelves on telescopic guide rails</b>	Yes
<b>Type of internal light</b>	LED
<b>Air filter</b>	Activated charcoal filter

## Functions



<b>Control setting</b>	Touch controls	<b>Child lock</b>	Yes
<b>Controls</b>	External, in the door	<b>Forced light on</b>	Time-limited
<b>Display type</b>	LED	<b>Continuous fan mode</b>	Yes
<b>Display functions</b>	Temperature Alarm, Temperature indication	<b>Temperature Alarm</b>	Yes
<b>Power-on indicator</b>	Yes	<b>Door open alarm</b>	Yes

## Technical Features

<b>Adjustable temperature zones</b>	2	<b>Number of compressors</b>	1
<b>Independent cooling systems</b>	2	<b>Compressor type</b>	Reduced vibration
<b>Number of door glasses</b>	2	<b>Refrigerant gas type</b>	R600a
		<b>Refrigerant quantity</b>	26.5 oz
		<b>Foam agent</b>	Cyclopentane

Temperature range	41°-68°F	Metal back panel	Metal
Temperature setting type	Electronic	Adjustable feet	2 Front + 2 Rear
Anti-UV door glass	Yes		
Integrated heating element	Yes		

## Performance / Energy Label NEW

Noise level	43 dB(A) re 1pW
-------------	-----------------

## Electrical Connection



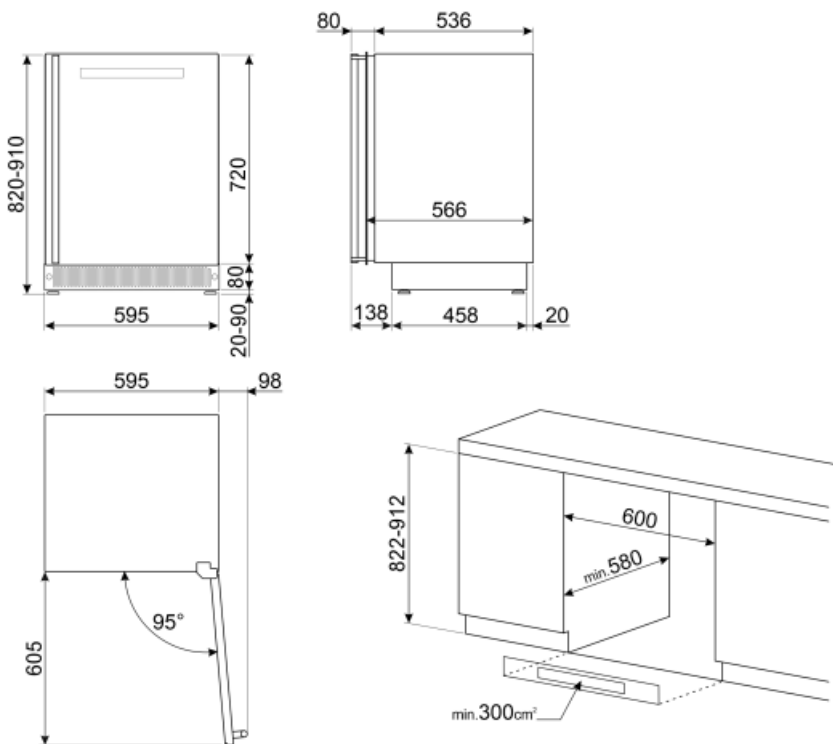



Plug	(A) USA & Mexico	Voltage (V)	120 V
Electrical connection rating	40 W	Frequency (Hz)	50/60 Hz
Current	1,95 A	Power cord length	59 1/16 "



---

## Symbols glossary (TT)

---

- |  |  |   |  |
|--|--|---|--|
|  | The automatic defrost system works by automatically defrosting at regular intervals eliminating the need to defrost altogether.            |  | LED display: to show programmes, functions and options selected and the time to the end of the cycle.              |
|  | Ventilated: Forced distribution of cold air in the refrigerator compartment, which allows even temperature distribution within the fridge. |  | Fingerprint proof stainless steel: Fingerprint proof stainless steel keeps stainless steel looking as good as new. |
|  | LED interior lighting: is a more energy efficient and long lasting way of illuminating the interior of the appliance.                      |  | Built-in niche   |
|  | Touch controls: Easy to use touch controls allow the appliance to be programmed at the touch of a button.                                  |   |  |