

Miele

Operating and Installation Instructions

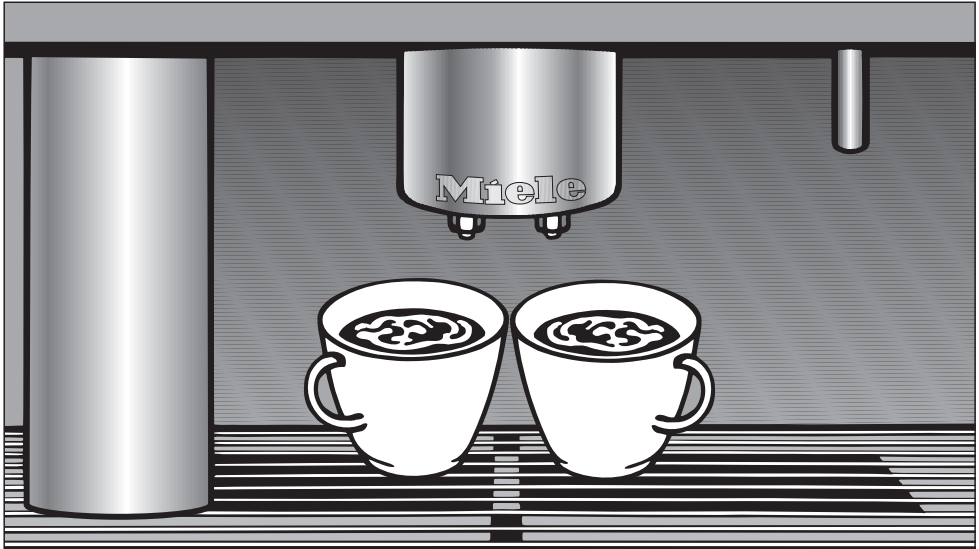

Coffee System with convertible water connection CVA 4066

To prevent accidents
and machine damage
read these instructions

before

installation or use.

en - US, CA

M.-Nr. 07 357 310

Contents

IMPORTANT SAFETY INSTRUCTIONS	4
Guide to the coffee system	8
Included accessories	10
First steps to use	11
Touch controls	11
Display	11
Filling water, beans or ground coffee	13
Filling the water tank	13
Filling the bean container	14
Filling ground coffee	14
Preparing drinks	15
Turning on	15
Pre-warming cups	15
Adjusting main dispenser height	16
Coffee and espresso prepared from coffee beans	16
Coffee and espresso prepared from ground coffee	17
Beverages with milk	18
User profile beverages	20
Adjusting the coffee grinder	21
Settings	22
Language	22
Time of day	23
Timer	24
Coffee jug (dispensing several servings, one directly after another)	25
Amount of coffee	26
Pre-brewing	26
Temperature	27
Automatic rinsing	27
Steam system	28
Lighting: Adjusting the brightness	28
Lighting: Setting the switch-off time	29
Info (displaying No. of drinks)	29
System lock	30
Water hardness	30

Display	31
Tone options	32
Water supply	32
Showroom program	32
Restoring factory default settings	33
Setting the serving sizes	34
User profiles	37
Selecting a user profile	37
Cleaning and care	40
Overview	40
Descaling the appliance	51
Frequently asked questions	53
After sales service	61
Installation instructions	63
Caring for the environment	64
Plumbing	65
Electrical connection	66
Installation	67
Adjusting the door hinges	69

IMPORTANT SAFETY INSTRUCTIONS

When using electrical appliances basic safety precautions should always be followed, including the following:

Read all instructions before installation or use of the coffee system.

Please read these instructions carefully to prevent accidents and machine damage.

This appliance complies with current safety requirements. Improper use of the appliance can cause personal injury and material damage.

Read this safety information carefully before operating the appliance. They contain important information on the safe installation, operation, and care of your coffee system. To avoid the risk of personal injury or damage to the coffee system, it is important that you carefully read the instructions.

Keep them in a safe place and pass them on to any future user.

Proper use

► This coffee system is for household use only, for the preparation of coffee beverages (espresso, cappuccino, latte macchiato, etc.).

Do not use this machine other than for its intended use. Any other use could be hazardous. The manufacturer will not be held liable for damage caused by unauthorized use or improper operation of any kind.

Persons which lack physical, sensory or mental abilities or experience with the machine should not use it without supervision or instruction by a responsible person.

Children

► Close supervision is necessary when any appliance is used by or near children. They could easily be scalded or burned.

► Never let children play with the coffee system.

IMPORTANT SAFETY INSTRUCTIONS

Technical safety

- ▶ Before installing the appliance, check for externally visible damage. Do not operate a damaged appliance.
- ▶ Before connecting the appliance to the electrical supply make sure that the voltage and frequency listed on the data plate correspond with the household electrical supply. If in doubt, consult a qualified technician.
- ▶ Be certain your appliance is properly installed and grounded by a qualified technician. To guarantee the electrical safety of this appliance, continuity must exist between the appliance and an effective grounding system. It is imperative that this basic safety requirement be met. If there is any doubt, have the electrical system of the house checked by a qualified electrician. The manufacturer cannot be held responsible for damages caused by the lack, or inadequacy, of an effective grounding system.
- ▶ The appliance must be properly installed before operation to ensure that no electrical components are accessible. Ensure that power is not supplied to the appliance while installation work, repairs or maintenance is performed.
- ▶ Do not use an extension cord to connect the appliance to electricity. Extension cords do not guarantee the required safety of the appliance (danger of overheating and open ground circuit).
- ▶ Do not install or use outdoors even if installed in the display cabinet.
- ▶ Before service or maintenance disconnect the power supply by either removing the fuse, "tripping" the circuit breaker or unplugging the unit.
- ▶ This appliance is not designed for maritime use or for use in mobile installations such as recreational vehicles or aircraft. However, under certain conditions it may be possible for installation in these applications. Please contact the Miele Technical Service Department with specific requirements.
- ▶ The unit is designed for a cold water connection. Do not connect it to hot water, it will get damaged.
- ▶ The water supply must be accessible after installation.
- ▶ Do not damage or kink the cover of the water intake hose.
- ▶ The waterproof system will only work if:
 - it is installed correctly.
 - it is damaged, the machine repaired or faulty parts replaced.
 - the water supply is shut off when not using the coffee system for an extended period of time, e.g. vacationing.
- ▶ Installation work and repairs must only be performed by a trained technician in accordance with national and local safety regulations. Repairs and other work by unauthorized persons could be dangerous and may void the warranty.

IMPORTANT SAFETY INSTRUCTIONS

- ▶ While the appliance is under warranty repairs should only be performed by an authorized service technician. Otherwise the warranty is void.
- ▶ Defective components should be replaced by Miele original spare parts only. Only with these parts can the manufacturer guarantee the safety of the appliance.
- ▶ To protect against fire, electric shock and injury to persons do not submerge the cord or plugs in water or other liquids.
- ▶ Do not let the cord hang over the edge of a table or counter, or touch hot surfaces.
- ▶ Do not operate any appliance with a damaged cord or plug, or after the appliance malfunctions or has been damaged in any manner. Contact Miele.
- ▶ Always attach the cord to the appliance first, then plug it into the wall outlet. To disconnect, turn the machine off, then remove the plug from the wall outlet.
- ▶ Never open the outer casing of the appliance. Tampering with electrical connections or components and mechanical parts is dangerous and may cause machine damage.
- ▶ If installed in combination with another appliance, a protective base must be installed between the coffee system and the appliance.
- ▶ Install or locate this appliance only in accordance with the provided installation instructions.

Use

Caution! Do not look directly or with an optical instrument into the lighting - laser radiation.

Caution! Risk of burns when dispensing hot beverages, they are extremely hot.

- ▶ Before the first use, flush the supply lines for water and milk and thoroughly clean the coffee system and stainless-steel milk container.
- ▶ Only fill the water tank with cold, fresh tap water. Warm or hot water, or any other liquids may damage the machine. The water should be changed daily to prevent bacteria or mold growth.
- ▶ Do not use deionized or mineral water. They may lead to heavy calcium built-up in the machine that can damage the unit.
- ▶ Do not put anything but coffee beans into the beans container. Do not put ground coffee in the beans container, it will damage the grinding unit.
- ▶ Do not fill anything but ground coffee or a cleaning tablet (for the brew unit) in the funnel for ground coffee, otherwise it will get damaged.
- ▶ Only use plain milk. Flavored milk products contain substances that can clog the coffee system.

IMPORTANT SAFETY INSTRUCTIONS

- ▶ Sugar can damage the appliance! Caramelized or otherwise pre-treated coffee beans or other sugar containing beverages must not be put in the machine.
- ▶ Never place a cup with an alcohol-coffee mixture underneath the main dispenser. Plastic parts of the unit could catch fire!
- ▶ The hot water and steam dispensed could cause scalding. These functions must be used carefully. Never hold any parts of the body under the steam nozzle or the hot water dispenser. The machine must never be used to clean objects.
- ▶ Never use a steam cleaner to clean the appliance. Pressurized steam could damage electrical components and cause a short circuit.
- ▶ Clean the coffee system daily to prevent bacterial growth. All parts of the coffee system are dishwasher-safe except for the brew unit, bean container, stainless-steel milk container and lid, and main dispenser cover. Failure to properly maintain machine may cause health issues.
- ▶ Be aware of how long milk is stored in the milk container. If milk is not continually cooled it can readily spoil causing illness. Be sure the milk container and pipework are properly cleaned and maintained. See "Cleaning and Care" for more information.
- ▶ To avoid injuries allow the coffee system to cool before cleaning or putting on and taking off parts. Turn the machine off at the main switch when not in use and before cleaning.
- ▶ The appliance must be descaled regularly with the supplied descaling tablets. In areas with very hard water the machine may need to be descaled more often. The manufacturer cannot be held responsible for damages resulting from insufficient descaling.
- ▶ Only use the descaling tablets provided by Miele. Take care to use the correct mixture of water and descaler, otherwise it may cause damage.
- ▶ Depending on the oil content of the coffee, the brew unit may clog. Clean the brew unit every 200 cups with a cleaning tablet. The display shows a reminder message.
- ▶ Dispose of the coffee waste in a trash can, not in the sink. The sink could get clogged.
- ▶ Do not hang, lean, sit or place heavy items on the door. The machine could be damaged.
- ▶ The use of accessory attachments not recommended by the appliance manufacturer may result in fire, electric shock or injury to persons.
- ▶ The appliance is designed for use in room temperatures between 59 °F and 140 °F. Do not use the appliance outside of this range of temperatures.

The manufacturer cannot be held liable for damage caused by non-compliance with these Important Safety instructions.

**SAVE THESE INSTRUCTIONS
AND REVIEW THEM
PERIODICALLY**

Guide to the coffee system

Front view

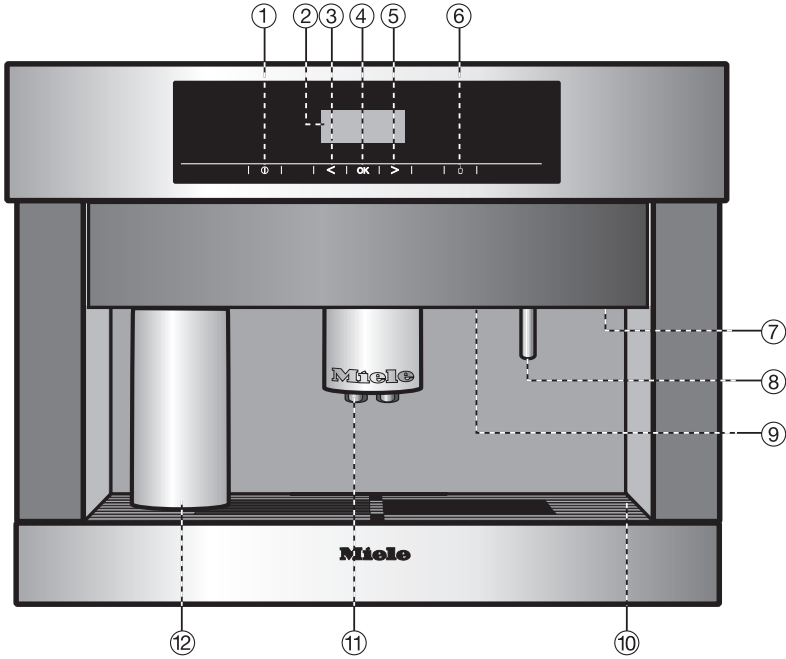

- ① On/Off ① touch control
- ② Display
- ③ Left arrow <, to scroll through program options
- ④ OK touch control, to confirm selected program options and save settings
- ⑤ Right arrow >, to scroll through program options
- ⑥ Hot water  touch control
- ⑦ Door grip
- ⑧ Hot water dispenser
- ⑨ Lighting
- ⑩ Drip tray
- ⑪ Main dispenser, height-adjustable
- ⑫ Stainless-steel milk container

Interior view

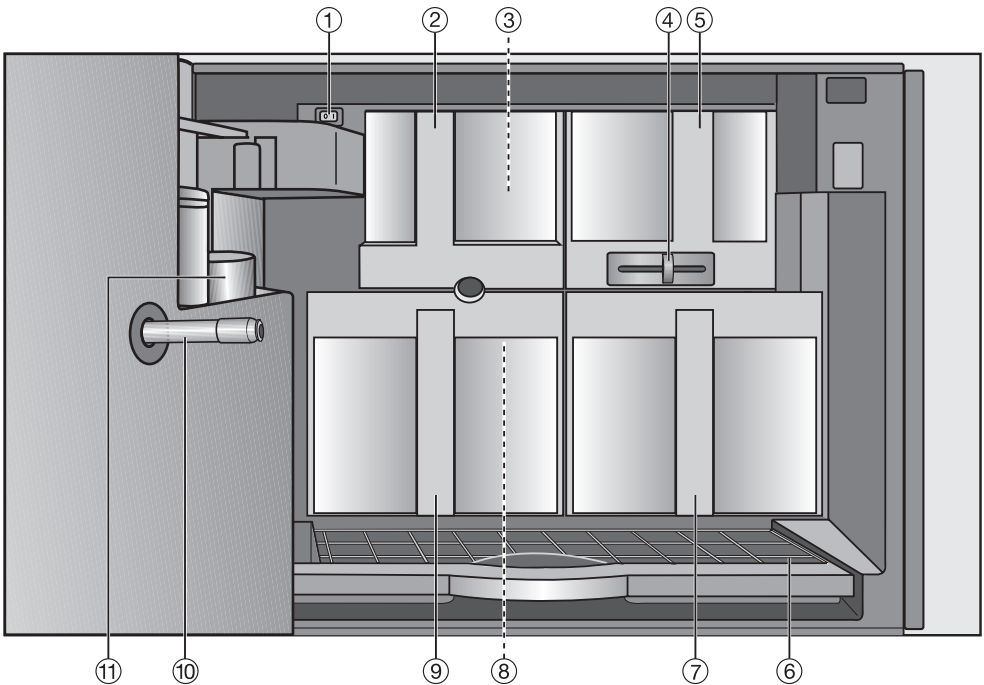

- ① Main switch
- ② Storage drawer
- ③ Ground coffee chute
- ④ Grind control slide
- ⑤ Coffee bean container
- ⑥ Drip tray with no-spill grid for transport
- ⑦ Water tank
- ⑧ Brew unit
- ⑨ Waste unit
- ⑩ Main dispenser connector (connects the brew unit to the main dispenser)
- ⑪ Stainless-steel milk container

Guide to the coffee system

Included accessories

Stainless steel milk container



To hold and insulate milk, with lid/handle and additional cover for storing milk in the refrigerator (not dishwasher-safe)

Cleaning containers

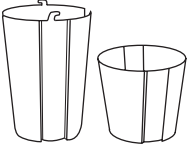

Large and small, for rinsing and cleaning the milk lines

Coffee spoon

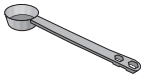

To measure ground coffee

Cleaning agent



For daily cleaning of the milk lines

Cleaning tablets



To clean the brew unit

Descaling tablets



To descale the coffee system

Additional accessories are available. Contact Miele or visit the Miele.com web site for more information









Touch controls

Select a touch control with your fingertip to use the machine.

Display



The main menu in the display shows the following symbols:

-  Espresso
-  Coffee
-  Cappuccino
-  Latte macchiato
-  Hot milk
-  Milk froth
-  User profile for up to nine different users
-  Maintenance programs
-  Settings: to customize your coffee system

Use the arrow buttons to select a program item from the display. Once highlighted, confirm with OK.

Before the first use

The appliance must be correctly installed and connected before the first use. See "Electrical connection", "Plumbing" and "Installation instructions".

Clean the appliance and remove any protective film before the first use. See "Cleaning and Care".

Turning on

- Select On/Off  to turn the machine on.

The first few times the machine is turned on with the main switch, a welcome screen will appear briefly on the display, followed by additional messages. The welcome screen is displayed each time the machine is turned on until 5 drinks have been prepared:



During the very first use, you will be prompted to select a **language**.

- Tap < or > until the desired language appears in the display.
- Confirm with OK.
The language is now set.

First steps to use

You will then be prompted to set the **Time format**.

- Tap < or > until the time format you wish to select (12-hour or 24-hour) is highlighted, confirm with OK.
- Enter the **Time of day**: First set the hours using < or >, confirm with OK. Repeat to set the minutes.
- Now specify when the time of day should be displayed:
 - **On**: The time will be displayed even when the machine is turned off.
 - **On for 60 seconds**: The time will be displayed for 60 seconds after the machine has been turned off.
 - **Do not display**: The display will go dark as soon as the machine is turned off.
- Confirm with OK.

Select OK to confirm the message indicating that your coffee system is communication enabled.

If everything has been entered correctly, **Set up successful** will appear in the display.

- Confirm the message with OK.

Turning off

- Tap the On/Off button  to turn the machine off.

If the automatic rinse feature is enabled, the machine will start the rinse cycle as soon as a coffee or milk-based drink has been dispensed. It will not shut off until after the rinse cycle is complete.

Filling water, beans or ground coffee

Clean the appliance thoroughly before loading the water tank and bean container (see "Cleaning and care").

Be sure to enter the water hardness (see "Settings - Water hardness").

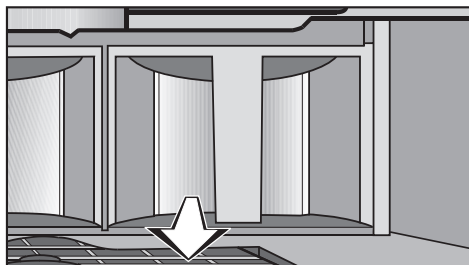

Filling the water tank

The beans and the water quality is important for a good espresso or coffee. The water tank must be washed and filled with fresh cold drinking water before each day of use. The unit displays a reminder when turned on.

Never add hot water or any other liquids except cold water to the water tank.

Do not use deionized or mineral water. They may lead to heavy calcium built-up in the machine that can damage the unit.

- Pull the water tank out.
- Fill the container with fresh, cold tap water to the "Max." mark.

The valve on the water tank ensures that water cannot leak out.

- Close the lid and push the water tank into the unit until it clicks into place.

The water tank must be positioned correctly or the valve will leak. If the water tank has not clicked into place, pull the tank out, check and clean the niche.

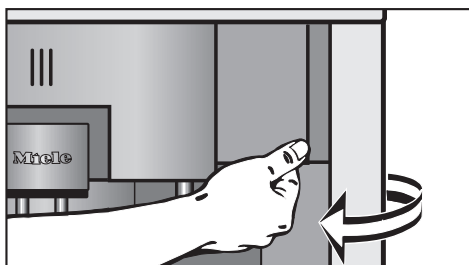

- Open the appliance door.

Filling water, beans or ground coffee

Filling the bean container

Only fill espresso or coffee beans in the beans container. Anything else - including ground coffee - will damage the grinding unit.

Caramelized, flavored or otherwise pre-treated beans or sugar containing beverages must not be filled into the appliance. It will damage the coffee system.

- Pull the bean container out.

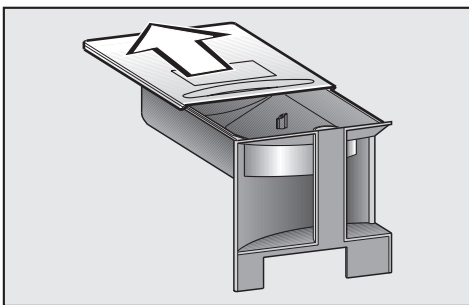

- Push the lid back and fill the container with roasted coffee beans.
- Push the lid back into place and put the beans container back into the appliance.
- Close the door.

Filling ground coffee

A funnel for ground coffee is provided in case you would like to prepare a different coffee type, e.g. decaffeinated coffee.

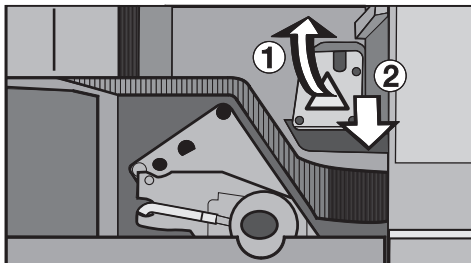

- Pull the storage drawer out of the appliance and lift the funnel lid, ①.
- Place one spoonful of ground coffee into the funnel, ②, (using the supplied spoon) and close the lid.
- Push the drawer back into the appliance and close the door.

See "Preparing drinks - Espresso and coffee made from ground coffee".

Clean the coffee system daily to prevent bacterial growth. All parts of the coffee system are dishwasher-safe except for the brew unit, bean container, stainless-steel milk container and lid, and main dispenser cover. Failure to properly maintain machine may cause health issues. See "Cleaning and Care".

The lines should be rinsed daily before the first use. This will happen automatically if the rinsing feature is set to "On" (see "Settings - Rinse Automatic") and the machine is cold. After heating, hot water runs out of the two spouts into the drip tray. If the rinse feature was set to "Off", select "Rinsing" to rinse the lines. See "Cleaning and Care - Rinsing the system".

Turning on

- Select On/Off .

The following message appears in the display:

Heating phase

If the automatic rinse feature is set to "on" (factory default), the following message is displayed after the heating phase:

Rinsing

Water will now flow from the main dispenser and into the drip tray. The machine will notify you when the drip tray is full, but the tray should be emptied daily.

The main menu then appears in the display:



Pre-warming cups

All beverages should be made in a warm cup, to develop the aroma. The smaller the amount of coffee or espresso and the thicker the cups, the more important it is to pre-warm the cups.

- Place an empty cup under the hot water spout.
- Select hot water .
- Hot water is dispensed. Select OK to stop the flow.
- Let the hot water sit for a moment to pre-warm the cup, then empty the cup and prepare the beverage.

Preparing drinks

Adjusting main dispenser height

The height of the main dispenser can be adjusted, to keep the shortest distance to the cup and retain heat, and maintain a better crema and froth.

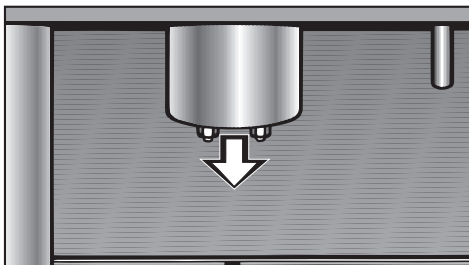

- Slowly pull the main dispenser up or down as desired.

Coffee and espresso prepared from coffee beans

Espresso, coffee, double espresso, and double coffee are all prepared in the same way:

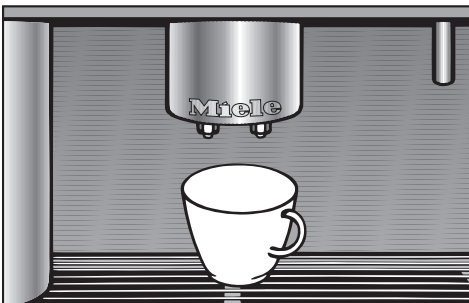

- Place a cup under the main dispenser.

The beverage is dispensed through both dispensers at the same time.



- Use the arrow buttons to select the desired beverage, confirm by tapping OK **once**.

The machine grinds the beans and pre-brews the coffee (if "On" is selected under "Pre-brewing"). The selected beverage is dispensed.

Do not open the appliance door during the brewing process. The appliance will be damaged.

Discard the very first two coffees dispensed once you have started to using the appliance, this will ensure that any coffee residue from factory testing is eliminated from the brew unit.

Double portion

If you would like a double portion of coffee or espresso, or to prepare two portions at the same time,

- tap the **OK button a second time**, while the display reads "2 portions?".

The two portions are always prepared **one after the other**.

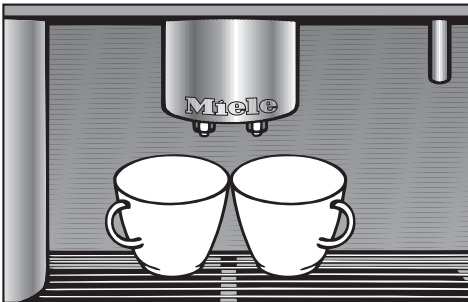

- To fill two cups at the same time, place one cup under each spout.

Be sure to wait for 2 dispensing cycles to be completed before removing the cups.

Interrupting preparation

- Tap OK when you see "Stop" in the display.

Preparation will immediately stop.

Coffee and espresso prepared from ground coffee

After filling the funnel with ground coffee (see "Filling water, beans or ground coffee - Filling ground coffee"), the display shows:

Make the coffee?

Yes

No

- Tap < or > until "Yes" is highlighted.

Select "No" if no ground coffee is filled in the funnel. Otherwise the coffee system assumes that ground coffee is in the machine and dispenses only water the next time coffee is made.

The display reverts to the main menu, and you can select the desired beverage type.

Preparing drinks

Prepare beverages

- Place a cup under the main spout.
- Tap the OK button.

The appliance brews the espresso or coffee, and the selected beverage is dispensed from the main spout.

Do not open the appliance door during the brewing process. The appliance will be damaged. After dispensing, the appliance **automatically** reverts to **bean operation**.

Interrupt preparation

- During preparation, tap the OK button when "Stop" appears in the display.

Preparation will immediately stop.

If you use ground coffee, only **one** serving is prepared at a time. The appliance always uses the entire portion of ground coffee loaded into the funnel, for **one** beverage.

Beverages with milk

Stainless steel milk container

The stainless steel milk container is vacuum insulated, to keep milk cold for a period of time. With an ambient temperature of about 68°F (20°C), milk at 43°F (6°C) can be stored for 11-12 hours and remain under 55°F (13°C). (Milk that is warmer than 55°F (13°C) should not be used because it will not make good milk froth.)

Milk cannot be stored as long if there is a warming drawer underneath the coffee machine.

Do **not** fill the container to the rim, leave a gap of approx. 1" - 1 ½" (2 - 3 cm) from the top.

Make sure to keep the top and seals of the container clean. Soiling can cause affect the functioning of the milk container.

Cold milk is best for creating froth.

Always pre-warm the cup with hot water, before you prepare a beverage.

To prepare beverages with milk,

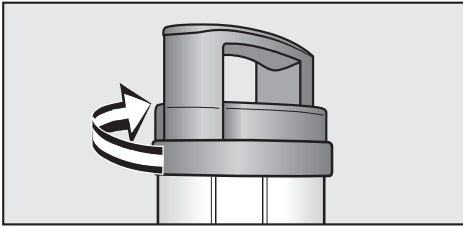

- place the lid on the stainless steel milk container and turn the lid to the left, so that it clicks into place.

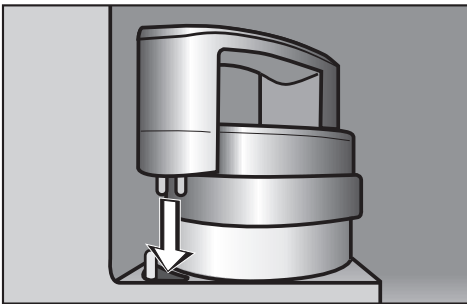

- Open the appliance door and hang the milk container in the appliance (as shown).
- Close the appliance door.

Cappuccino, latte macchiato, hot milk, froth

- Place a suitable cup or glass under the **both** dispensers.

For best results when preparing a latte macchiato, place the glass under the spout in such a way that the espresso flows into the middle of the froth.

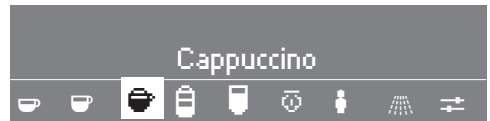

- Tap the right arrow button until the beverage symbol is highlighted, tap OK **once**.
- To **interrupt preparation**, tap OK again.

To set the proportions for beverages (coffee, espresso, froth, hot milk), see "Setting serving sizes".

After preparing your drink a "Clean the milk pipework" reminder will appear in the display.

- Tap OK to return to the main menu.

Preparing drinks

User profile beverages

The user profile function is used to prepare beverages to suit your taste, by adjusting the amounts of water, milk, and ground coffee, as well as temperature and pre-brewing (see "Creating a user profile").

If you have already created a user profile, first select it then prepare the beverage.

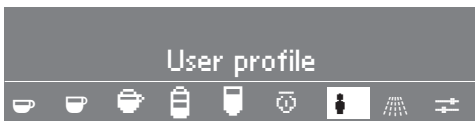

- Tap < or > until "User profile" is highlighted, confirm with OK.
- Tap < or > to select "Select", confirm with OK.
- Use < or > to select the desired user profile, confirm with OK.

A large user profile  symbol will appear in the display to show that a profile has been selected.

You can now operate the appliance as you would for a "standard" profile.

After use

Before turning the machine off, or at the end of the day, flush the water lines, the brew unit, the spouts and the milk lines in order to prevent the machine from clogging (see "Cleaning and care").

Adjusting the coffee grinder

The finer the coffee beans are ground determines the strength of the coffee and the quality of the crema.

To prevent machine damage adjust the coffee grinder **one level at a time** and let the beans grind before adjusting another notch. Otherwise the machine will be damaged.

The grinder should be adjusted:

- If the espresso flows too quickly into the cup, the pressure cannot be built up because the beans have been ground too coarsely. The grinder should be adjusted to a finer setting.
- If the espresso only trickles into the cup, the beans have been ground too fine and the coffee will be bitter. The grinder should be adjusted to a coarser setting.
- If the crema is evenly colored but pale, the ground coffee is too coarse.
- If the crema is very dark brown on one side, graduating almost to white on the other, the ground coffee is too fine.

To adjust the grinder setting

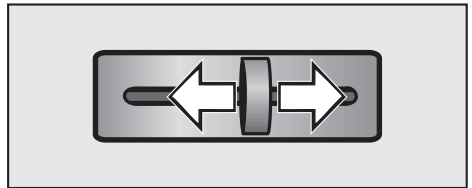

- Push the slide control to the left for a finer grind or to the right for a coarser grind.

You should be able to feel the notches when moving the slide control.

If the slide control will not move:

- Close the machine and dispense a cup of coffee.

Then try to move the slide control again.

Settings

The coffee system can be customized to suit individual preferences.

Settings menu



- Tap < or > until Settings  is highlighted. Confirm with OK.
- Tap < or > until the desired option is highlighted and confirm with OK.

The current setting(s) will be marked with a check.

To return to the previous options in the menu, select "Back .

The possible setting options are described in detail on the following pages.

Language

You can select the language for all text and messages displayed on your machine.

- Select "Settings " and confirm with OK.



- Tap OK.
- Tap < or > until the language you wish to select is highlighted.
- Confirm with OK.

This setting is automatically saved, and the display returns to the previous screen.

All display text will now appear in the language selected.

If you select the wrong language accidentally, follow the flag icon  to find the "Language" option.

Time of day

- Select "Settings", confirm with OK.



Settings

Time of day

Timer

- Tap < or > until "Time of day" is highlighted, confirm with OK.

Three options are now available:

Display

The time display can be turned on or off.

- Use < or > to select "Display".

You can now choose from among three settings:

- **"On"**: The time will be displayed even when the machine is turned off.
 - **"On for 60 seconds"**: The time will be displayed for 60 seconds after the machine has been turned off.
 - **"Do not display"**: The display will go dark as soon as the machine is turned off.
- Once a display format has been selected, confirm the setting with OK.

Clock format

- Use < or > to select "Clock format".
- Tap < or > to select a 24-hour or 12-hour display.
- While the desired options is highlighted, confirm with OK.

The clock format is now saved.

Setting the time of day

- Use < or > to select "Set".
- Tap < or > to set the hours. Confirm with OK. Repeat to set the minutes.

The time of day is now saved.

Settings

Timer

- Select "Settings ", confirm with OK

Settings

Timer

Coffee jug

- Select < or > until "Timer" is highlighted, confirm with OK.
- Use < or > to select "Set", confirm with OK.

Three options are now available:

Switch on at

You can program your machine to turn on automatically at a certain time, for example, at breakfast time.

- Tap < or > to select "Switch on at", confirm with OK.
- Tap < or > to set the hours. Confirm with OK. Repeat to set the minutes.

The machine will turn on each day at the specified time once you have **activated the timer** (see "Activate").

If the machine is turned on automatically three times and no beverages were dispensed, the machine will no longer turn on automatically. The programmed times stay saved and will be activated again when the machine is manually turned on the next time. This safety measure is designed so that the machine does not turn on every day if the setting was not canceled before a longer time of absence, e.g. vacationing.

Switch off after

The machine will turn off automatically to save energy after a programmed period of time (ranging from 15 minutes to 9 hours after the last use). When the "Switch off after" option is set, the machine will turn off automatically after the programmed amount of time.

- Use < or > to select "Switch off after", confirm with OK.

A display of 1:00, for example, indicates that the machine will turn off after one hour.

- Tap < or > to set the hours. Confirm with OK. Repeat to set the minutes.

The machine will now turn off after the programmed amount of time.

If the automatic rinse feature is turned on, and the machine has been used to prepare a beverage, it will always run a brief rinse cycle before turning off.

Switch off at

A specific time of day can be set to turn the coffee system off.

- Use < or > to select "Switch off at", confirm with OK.
- Tap < or > to set the hours. Confirm with OK. Repeat to set the minutes.

The machine will turn on each day at the specified time one you have **activated the timer** (see "Activate").

If the automatic rinse feature is turned on, and the machine has been used to prepare a beverage, it will always run a brief rinse cycle before turning off.

Activate

- Use < or > to select "Activate", confirm with OK.

The program items "Switch on at" and "Switch off at" are displayed.

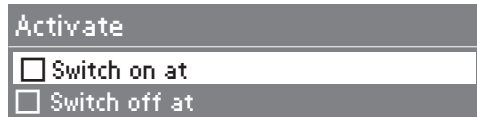

- Use < or > to select the program item(s) you wish to activate.

Tap OK to activate (select the check box) or deactivate (clear the check box) the desired option.

- Use < or > to select "Accept", confirm with OK.
- Use < or > to select "Back" , confirm with OK.

Coffee jug (dispensing several servings, one directly after another)

With this function, you can dispense up to eight servings of coffee one immediately after another. The brewing process will run automatically for all servings.

- From the main menu, select "Settings"  then tap ok.

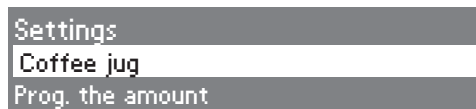

- Tap the right arrow button until "Coffee jug" is highlighted and then tap the OK button
- Using the arrow button, select the number of servings you wish to be dispensed (3 to 8) and confirm with OK.
- Place the desired container under the main dispenser and follow the instructions on the display.

Each cup of coffee will be individually ground, brewed and poured. Meanwhile, the display reports on the process while it is going on. You can interrupt the process at any time by tapping the OK button ("Stop").

- When the display shows the process is complete, confirm with OK.

Settings

Amount of coffee

The amount of coffee will determine both the strength and the crema of your brewed coffee.

Depending on the type of coffee, the ideal amount ranges from approximately 0.2 ounces and 0.5 ounces (6 g to 14 g per) cup. The higher the value, the stronger the prepared espresso, coffee, latte macchiato, or cappuccino will be.

The crema is also influenced by the amount of coffee.

- If the crema has an even but white/yellow coloring, the ground amount might be too little.
- If the crema is dark brown to black in color on the one side and almost white on the other side, the amount of coffee might be too much.
- Using < or > select Settings , and confirm with OK.

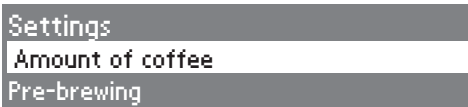

- Tap < or > until "Amount of coffee" is highlighted, confirm with OK.
- Use < or > to select a beverage, confirm with OK.
- Using < or > adjust the amount of coffee to "more" or "less".
- To save the setting, tap OK.

Pre-brewing

During the pre-brew step, the freshly ground coffee is first moistened with hot water. After a short steeping period, the remaining water is then forced through the moistened coffee at high pressure. This process produces a much more intense coffee aroma.

If the function is turned off, the hot water will be immediately pushed at a high pressure through the ground coffee.

You can program normal or long pre-brew or turn the pre-brew function off. The **default factory setting** for the **pre-brew** function of your machine is **Off (= without)**.

- Select "Settings ", and confirm with OK.



- Tap < or > until "Pre-brewing" is highlighted, confirm with OK.
- Tap < or > until the desired pre-brew setting is highlighted.

Tap OK to save the setting.

Temperature

Three temperature settings are available for each coffee beverage and two settings for hot water.

Not every coffee type allows high temperatures. Some types react so sensitively that the crema cannot be properly built.

- Select "Settings ", and confirm with OK.

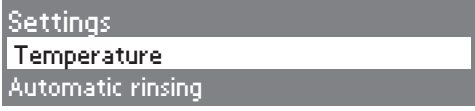

Settings
Temperature
Automatic rinsing

- Tap < or > until "Temperature" is highlighted, confirm with OK.
- Tap < or > until the beverage is highlighted in which you wish to set the temperature for. Confirm with OK.
- Tap < or > until the desired temperature is highlighted.
- Tap OK to save the setting.

Automatic rinsing

It is important to flush out any residual coffee from the lines when starting to use the machine for the day. If the automatic rinse function is activated and the machine is cold, the rinse cycle will begin automatically as soon as the machine is turned on. This will also pre-heat the lines with the hot water used during the rinse cycle. This is indicated by a message in the display. If a beverage has already been made, the machine will also automatically run a rinse cycle just before turning off.

The **factory default setting** for the automatic rinse function is On.

If you do not want the rinse water to collect in the drip tray, always place an empty cup or the small cleaning container underneath the main dispenser.

- Select "Settings ", confirm with OK.



Settings
Automatic rinsing
Steam system

- Tap < or > until "Automatic rinsing" is highlighted, confirm with OK.
- Tap < or > to select "On" or "Off", confirm with OK.

It is recommended that you set this program option to "On" to ensure that the rinse cycle will not be forgotten.

Settings

Steam system

This appliance has two heating systems, making it possible for you to prepare milk froth/hot milk and coffee/espresso, one right after the other. If you seldom need milk froth or hot milk, you can turn the steam heating system off to save energy.

If you select milk froth or hot milk with the steam heating system turned off, it will take a little longer, as the heater is only turned on once a milk option is selected. The steam heating system will remain **On** until the machine has been turned off completely.

- Select "Settings ", confirm with OK.



Settings
Steam system
Lighting

- Tap < or > until "Steam system" is highlighted, confirm with OK.
- Tap < or > to select "On" or "Off".
- Tap OK to save the setting.

Lighting: Adjusting the brightness

The brightness of the machine lighting can be adjusted.

- Select "Settings ", confirm with OK.



Settings
Lighting
Info

- Tap < or > until "Lighting" is highlighted, confirm with OK.
- Select "Brightness", confirm with OK.
- Use < or > to select a lighter or darker setting.
- Confirm with OK to save the setting.

If you continue to tap < all the way to the **left** until you can no longer see the small white bars, the **lighting will turn off**.

Lighting: Setting the switch-off time

Whenever the machine is On, the machine lighting is also On. The lighting turns off automatically when the machine has been idle for 15 minutes.

When the machine is turned off, you can program the lighting to remain On and to shut off automatically after a certain amount of time if the machine is not used

You can choose a duration from 15 minutes to 6 hours.

- Turn the machine off.
- With the machine turned off, confirm with OK.
- Select "Lighting", confirm with OK.
- Select "Switch off after", confirm with OK.
- Use < or > to select a switch-off time, confirm with OK.
- Select "Brightness" and tap OK
- Tap the arrow button to increase or decrease the brightness, then tap OK to save the setting (Factory Default: Off).
- Select "Back" symbol twice to exit the menu.

The machine will now automatically turn the lighting off after the programmed amount of time.

Info (displaying No. of drinks)

The "Info" option allows you to display the number of beverages that have been dispensed from the machine and the number of beverages the machine can still make before descaling is necessary.

- Select "Settings ", confirm with OK.



- Tap < or > until "Info" is highlighted, confirm with OK.
- Use < or > to select "No. of drinks" or "Portions until descaling", confirm with OK.

Under "No. of drinks", you can display "Total number of coffees" or a breakdown according to each individual coffee beverage, milk froth, milk, and hot water.

- Tap OK to go back to previous menu.

When the machine requires descaling, you will be notified automatically. It is not necessary to check these messages regularly.

Settings

System lock

The coffee system can be locked so that it cannot be used by children or those not familiar with the operating instructions.

When the machine is locked, the timer setting "Switch on at" will not work.

Activating/Deactivating the System lock

- Select "Settings" , confirm with OK.



Settings
Safety
Water hardness

- Use < or > to select "Safety", confirm with OK.
- Tap < or > until "System lock" is highlighted, confirm with OK.
- Use < or > to select "On", confirm with OK.

As soon as the machine is turned off, it will lock and cannot be turned back on. A closed padlock  and a message will appear in the display, whenever a button is touched.

To deactivate the system lock, follow the same procedure as above, but select "Off".

Overriding the system lock

- Press and hold OK for approx. 3 seconds.

The machine is now temporarily unlocked and can be used to prepare beverages. **It will lock again as soon as it is turned off.**

Water hardness

The hardness of the water used in the coffee system must be determined and programmed into the appliance. The water hardness will determine how frequently the unit must be descaled to maintain the coffee system properly. The machine monitors the volume of water used (including the amount required for producing steam), and will then let you know when a descaling cycle is necessary.

To measure the hardness of your water, use the test strip that is included in your installation kit.

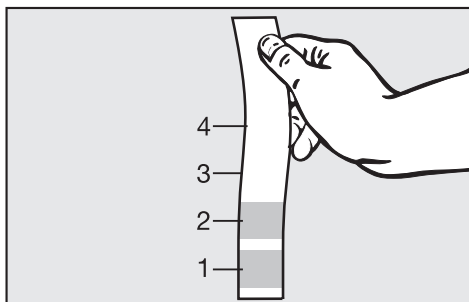

- Place the test strip under your kitchen tap for a second and shake off any remaining water. The result is visible in about 1 minute.

If the water hardness is greater than 40 gr/gal (40°D), the water **must** be descaled more often than displayed. Calcium will build up faster than at a lower water hardness and may damage the machine.

You can program four hardness levels on the machine:

- **Level 1 (soft):**
0 - 3 gr/gal (0 - 3 °d)
 - **Level 2 (moderately hard):**
4 - 7 gr/gal (4 - 7 °d)
 - **Level 3 (hard):**
7 - 15 gr/gal (7 - 14 °d)
 - **Level 4 (very hard):**
15 - 22 gr/gal (14 - 21 °d)
- Select "Settings ", confirm with OK.



Settings

Water hardness

Display

- Tap < or > until "Water hardness" is highlighted, confirm with OK.
- Tap < or > to program the water hardness level, confirm with OK.

The selected water hardness level is now saved.

Display

The display contrast and brightness can be adjusted.

- Select "Settings ", confirm with OK.



Settings

Display

Volume

- Tap < or > until "Display" is highlighted, confirm with OK.
- Tap < or > to select "Contrast" or "Brightness", confirm with OK.
- Tap < or > to adjust the contrast lower or higher or make the display brighter or darker.
- Tap OK to save the setting.

Settings

Tone options

A tone can be selected to confirm the selection of a touch control. The volume of the tone can also be adjusted.

- Select "Settings ", confirm with OK.



- Tap < or > until "Volume" is highlighted, confirm with OK.
- Tap < or > to select "Buzzer tones" or "Keypad tone", confirm with OK.
- Tap < or > to increase or decrease the volume.

If you continue to tap < all the way to the **left** until you can no longer see the small white bars, the **sound will turn off**.

- Tap OK to save the setting.

Water supply

This machine is designed for use with or without a plumbed water connection. If the "Plumbed water supply" option is set to "On", water is automatically taken into the water container. If the option is set to "Off", the water tank will need to be filled manually.

- Select "Settings ", confirm with OK.

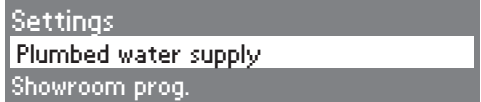

- Tap < or > until "Plumbed water supply" is highlighted, confirm with OK.
- Use < or > to select "On" or "Off", confirm with OK.

Showroom program

The showroom program is used to demonstrate the machine at exhibits. In this demo mode, the machine lighting is On, but the machine does not heat up.

Restoring factory default settings

The "Factory default" setting can be used to reset different settings back to their original default status.

You can select whether to reset **all settings** or delete any **user profiles**.

- Select "Settings ", confirm with OK.



- Tap < or > until "Factory default" is highlighted, confirm with OK.

Two options are now available:

User profiles

Selecting "User profiles" deletes all user profiles that you have entered, leaving only the default (standard) profile.

- Under "User profiles", select "Reset", confirm with OK.

The user profiles are deleted.

All settings

Selecting "All settings" restores all settings back to the factory default.

- Under "All settings", select "Reset", confirm with OK.

All settings are now reset to the default.

Factory default settings

- Amount of coffee (medium)
- Temperatures for coffee beverages and hot water (medium for both)
- Pre-brewing (without)
- Automatic rinse and steam system (both On)
- Showroom program (Off)
- Time display (On for 60 seconds), Time format (24 h), Timer - Switch on at (12:00), Timer - Switch off after (1:00), Timer - Switch off at (12:00), ("Switch on at" and "Switch off at" both deactivated)
- Coffee jug (3 cups)
- Lighting: Brightness (medium)
- Safety: System lock (Off)
- Water hardness (very hard 4)
- Display: Contrast (medium), Brightness (maximum)
- Volume: Buzzer tones and keypad tone (both at maximum setting)
- User profile: Revert (when machine is turned on)
- Plumbed water supply (On)

If "Reset" is selected by accident, turn the machine off **before** pressing OK, the settings will not be reset.

Setting the serving sizes

The flavor of a **coffee beverage** depends not only on the type of coffee, but also on the quantity of water used. Not every espresso or cappuccino cup is the same size. Use this feature to set the volume of water to suit your taste and cup sizes.

For **beverages with milk** the proportions of espresso, milk, and froth have an important impact on flavor. You can set the appliance to suit your preferences for cappuccino and latte macchiato.

To program serving sizes, you can either press and hold the OK button, or via the "Settings" option.

When a user profile is activated, the serving size is set for that particular profile only.

If you want to set the serving size for all profiles, select the "Standard" user profile.

Setting serving sizes of espresso, coffee, hot milk and milk froth using OK

- Place the desired cup under the main dispensers.
- Select the beverage type.
- Press and hold OK until the display reads "Prog. the amount".
- Tap OK again once the cup is filled to your desire. "Save" appears in the display.

The programmed volume of water or milk will now be dispensed each time that particular drink is selected.

Once the maximum water or milk volume is reached, the appliance automatically stops the water supply. The maximum fill amount for each beverage is then stored.

If the water tank or milk container becomes empty during portion programming, the process is canceled and the size is **not** stored.

Setting serving sizes for cappuccino and latte macchiato using OK

- Place the cappuccino cup or latte macchiato glass you will be using to set the portion size under the main dispensers.
- Select cappuccino or latte macchiato.
- Press and hold OK until the display shows the options for Cappuccino (Milk froth, Espresso) or Latte Macchiato (Hot milk, Milk froth, Espresso).

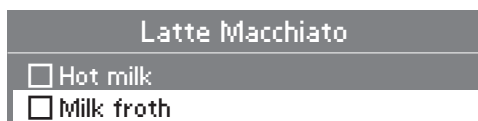

- Use < or > to reach the option you wish to program to a certain serving size.
- Tap OK to place a check mark next to the desired component to show that you would like to program this component.
- Repeat this process until all components you wish to program the serving size for are marked with a check.
- Use < or > to select "Start", confirm with OK.

The appliance now begins preparing a cappuccino or latte macchiato.



As soon as the component (which you have checked) is being dispensed, the display will read "Program the amount".

- Once the cup is full to your liking with that component and "Save" appears in the display, tap OK to save the amount.
- Repeat this process for the other components you have chosen for this type of coffee.

Each time the drink is prepared it will contain the programmed amount of coffee, milk, etc.

Setting the serving sizes

Setting the serving size for hot water

- Place the desired cup under the hot water dispenser.
- Tap  until the display reads "Prog. the amount".
- Tap  again once the cup is filled as desired and "Save" appears in the display.

Each time the hot water is prepared the programmed amount will be dispensed.

Setting serving sizes via "Settings"

- Select "Settings ", confirm with OK.

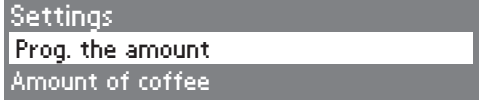

- Tap < or > until "Prog. the amount" is highlighted, confirm with OK.
- Use < or > to select the beverage you wish to set a serving size for.
- Select "Start", confirm with OK.

Proceed as you would for programming using OK or .

User profiles

Creating a user profile

- Tap < or > until "Create" is highlighted, confirm with OK.

Up to 9 user profiles can be created. If you try to create more than 9 user profiles, the message "**Memory full**" will appear, you will need to delete a profile to create space.

Letters and numbers will now appear in the display. Use < or > to select the desired letters or numbers.

A new word will always be capitalized, the appliance will then switch to lower-case letters.

- Use < or > to select the desired characters.
- Tap OK to confirm a character.

You will see the selected characters in the top line of the display.

If you **misspelled** a word, use the arrow buttons to select the trash can symbol, confirm with OK. The last character entered will be deleted.

Saving an entry

- Once you have completed an entry, use < or > to select "OK", confirm with OK.

The display will briefly show the User profile welcome screen, followed by the main menu.

Canceling an entry

- If you do not wish to save an entry you have made, use < or > to select "back ", confirm with OK.

Changing a user profile

- Select "Change user profile", confirm with OK.
- Select the user profile you wish to change, confirm with OK.

Continue as you would for "Creating a user profile".

Deleting a user profile

- Select "Delete user profile", confirm with OK.
- Use < or > to select the user profile you wish to delete, confirm with OK.

A check mark appears after the user profile, and it will be erased shortly.

Revert

The appliance can be set so that it automatically reverts to the standard user profile or continues to use the most recently selected user profile set.

- Use < or > to select "Revert".

You can now choose between:

Manually

The appliance retains the selected user profile until another profile is selected.

- Use < or > to select "Manually", confirm with OK.

After dispensing

After each drink prepared, the appliance automatically reverts back to the standard user profile.

- Use < or > to select "After each use", confirm with OK.

When switched on

Each time the appliance is turned on, the standard user profile will automatically be selected, no matter which user profile was set before it was last turned off.

- Use < or > to select "When switched on", confirm with OK.

Cleaning and care

Overview

Frequency	What needs to be done?
Every time milk is prepared, if there is more than one hour between uses	Rinse the milk pipework
Every day (at least at the end of the day, before you switch off the appliance)	Flush the system (intake lines)
	Clean the milk lines (with cleaning powder)
	Clean the stainless steel milk container and lid
	Clean the main dispenser
	Clean the water tank
	Clean the waste unit
	Clean the drip tray and no spill grid
Once a week (more often if there is a heavy soiling)	Clean the bean container
	Clean the main dispenser connector
	Clean the interior
	Clean the inside door tray
	Clean the brew unit
	Clean the front of the appliance (especially right after descaling)
Once a month	Lubricate the cap on the main spout connection
Approx. every 200 portions	Clean the brew unit (use the cleaning tablets)
Depending on the water hardness	Descale the appliance

Allow the coffee system to cool before cleaning. Danger of burns!

Do not clean the unit with a steam cleaner.

Never use cleaners containing chlorides, sand, baking soda or scouring agents. These will damage the surface.

To avoid mold, growth and odors it is important to clean the machine regularly.

All removable parts are dishwasher-safe, **except** the following:

- Brew unit
- Bean container
- Stainless-steel milk container and lid
- Main dispenser cover

When the parts are cleaned in the dishwasher they might get discolored by food residues such as tomatoes or their surface coating may become damaged.

Rinsing the system

Before switching your machine off for an extended period of time, you should clean the supply lines, the brew unit, and the main dispenser.

If you have turned off the automatic rinse feature (see "Settings - Automatic rinsing"), the lines will need to be rinsed manually. When performing a manual rinse cycle, it is recommended that you place the small cleaning container under the main dispenser.



- Tap < or > until "Maintenance" is highlighted, confirm with OK.
- Select "Rinse the system", confirm with OK.
- Select "Start", confirm with OK.

When the main menu reappears in the display, the lines have been rinsed. The appliance can now be turned off.

Cleaning and care

Milk pipework

Rinsing the milk pipework

To prevent the milk residue from spoiling or drying in the machine and pipework, you should clean these lines after use. In addition to rinsing after use, the lines need to be cleaned at the end of the day.



- Tap < or > until "Maintenance" is highlighted, confirm with OK.
- Select "Rinse milk pipework", confirm with OK.
- Select "Start", confirm with OK.
- Follow the instructions in the display.

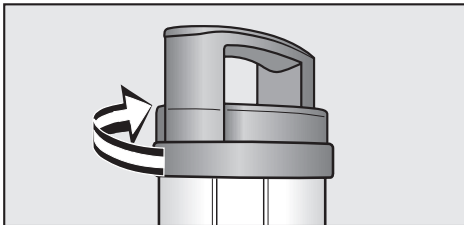

To rinse the pipework in the lid of the stainless-steel milk container, fill the large cleaning container to the "max." mark with **cold** water. Fit the lid of the stainless-steel milk container into place on the large cleaning container. Place the cleaning container in the appliance where the milk container would normally sit.

Cleaning the milk pipework

To prevent milk residue from spoiling or drying in the machine and pipework, it should be cleaned at the end of each day milk was used to make a beverage.

- If the milk pipework in the lid is clogged, clean under running water using the cleaning brush. Insert the cleaning brush into the pipework, and push it in and out.



- Tap < or > until "Maintenance" is highlighted, confirm with OK.
- Select "Clean milk pipework", confirm with OK.
- Select "Start", confirm with OK.
- Follow the instructions in the display.

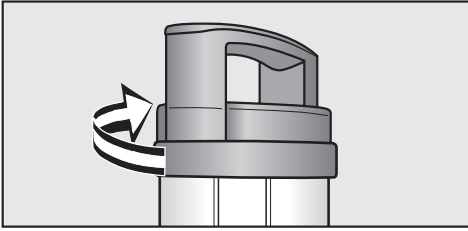

To rinse the pipework in the lid of the stainless-steel milk container, fill the large cleaning container to the "max." mark with **lukewarm** water to dissolve the cleaning agent. Fit the lid of the stainless-steel milk container into place on the large cleaning container. Place the cleaning container in the appliance where the milk container would normally sit.

Use only Miele cleaning agent, which was developed especially for this coffee system. You can obtain this cleaning agent from your Miele dealer or the Miele.com website.

The cleaning process has now begun. When **Prog. finished** appears on the display, the lines are clean, and you can turn the machine off.

Stainless-steel milk container

The stainless-steel milk container and lid must be cleaned **by hand** with hot water.

Make sure to keep the top and seals of the container clean. Soiling can cause affect the functioning of the milk container.

- Clean the stainless-steel container with hot water.
- Rinse the handle under running water and then clean it thoroughly with a damp cloth to remove all milk residue.
- If the milk pipework in the lid is clogged, clean under running water using the cleaning brush. Insert the cleaning brush into the line, and push it in and out.

Cleaning and care

Main dispenser

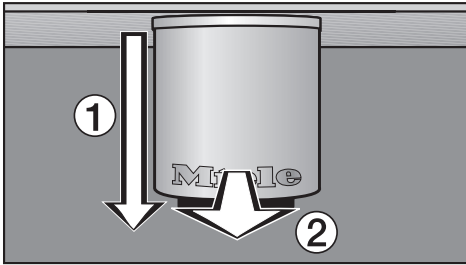

- Pull the main dispenser all the way down ① and pull the cover forward to remove ②.

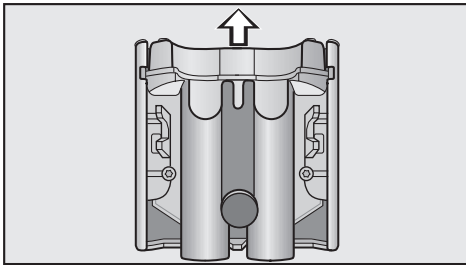

- Turn the cover around, slide the insert upward and out, and clean both parts thoroughly.
- Slide the insert back into the cover until it clicks into place.

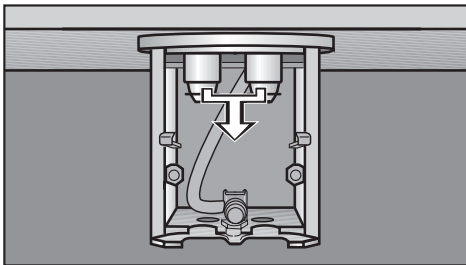

- Pull the nozzles of the main dispenser out.

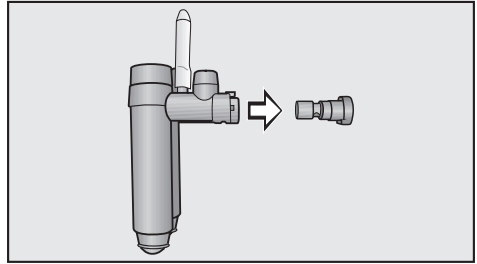

- Pull both rubber stoppers out and clean the stoppers and nozzles thoroughly.
- Put the rubber stoppers back into place.

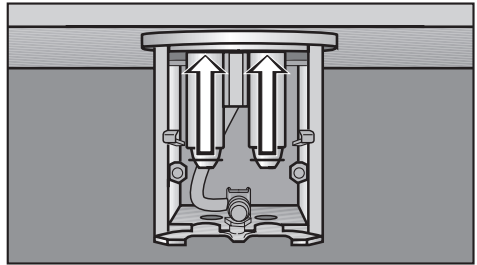

- After cleaning the nozzles of the main dispenser, slide them back into the machine firmly upward to ensure they are securely in place.
- Replace the cover and slide the main dispenser up.

Water tank

Empty the water tank daily and refill before preparing the first drink with fresh, cold tap water.

Check if the valve is clean. If the valve has residues on it, the water tank will not connect properly and might leak.

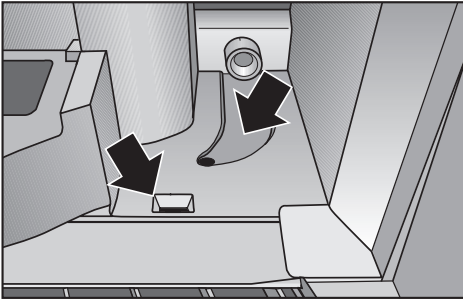

- Clean the niche of the water tank.
- For cleaning, remove the plastic spout from the lid of the water tank.

Waste unit

The display shows a message to empty the waste unit. Clean the waste unit **daily**. Coffee waste can mold if there is water in the waste unit from the rinse process.

There may be water in the waste container from the rinsing process. This is normal.

Line the waste unit with a paper towel to make for easier cleaning.

- Pull the waste unit out.
- Wash the waste container in the dishwasher or by hand with hot water and liquid dish soap and dry with a soft cloth.
- Thoroughly clean the niche of the waste unit in the machine.
- Push the waste unit completely into the machine.

Cleaning and care

Drip tray

The drip tray contains a sensor which causes the display to show when the tray is full and needs to be emptied.

Clean the drip tray **daily**.

Remove the drip tray after the final rinse when no more water runs from the lines.

Carefully remove the drip tray from the machine; the water may be very hot and could cause scalding.

- Open the door and pull the drip tray out.

The drip tray contains a grid to avoid spilling during transport.

- Wash the drip tray and grid in the dishwasher or by hand with hot water and liquid dish soap, then dry with a soft cloth.

Take care that the metal contacts at the back of the drip tray are clean and dry. If the contacts are soiled or wet the unit cannot detect when the drip tray is full and needs to be emptied.

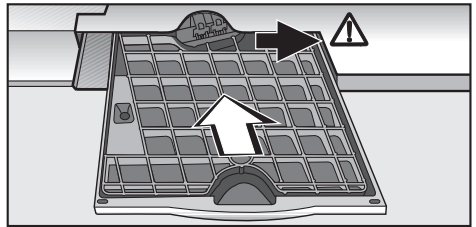

- Push the drip tray with grid along the right edge all way in the machine.
- Close the door.

Drip tray cover

- Remove the drip tray cover and wash it.

Bean container

The bean container must be cleaned **by hand** with hot water and liquid dish soap. **Do not use a dishwasher.**

- Pull the bean container out and push the lid back.
- Wash the bean container by hand with hot water and liquid dish soap, then dry with a soft cloth.
- Push the lid back and reinsert the bean container into the machine.

Main dispenser connector

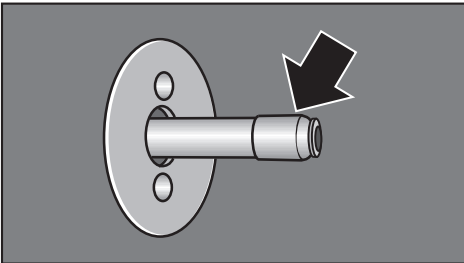

A connecting piece between the brew unit and the main dispenser is located on the inside of the door.

- Clean this connector regularly with a damp cloth without removing the lubricant for the cap.
- Lubricate the cap once a month with the supplied food grade silicone lubricant.

Interior and door

- Once all movable parts are removed clean the interior with a solution of hot water and liquid dish soap.

Dry ground coffee can be vacuumed.

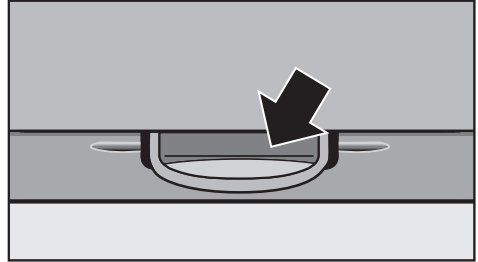

- The lower part of the inner door has a drip tray. Clean the drip tray.

Cleaning and care

Brew unit

Manually clean the brew unit weekly. The movable parts are lubricated and the gaskets will get damaged in the dishwasher. **Do not use a dishwasher** this will cause damage.

- Take out the water tank, waste unit and the storage drawer.

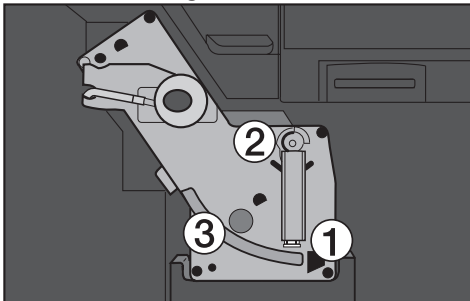

- Press the light colored button on the brew unit handle, ①, and turn the handle to the left, ②.
- Press the brew unit catch, ③, downwards and carefully pull the brew unit out.

The brew unit is not in the correct position if it is hard to pull out. See "Frequently asked questions".

- Clean the brew unit under running warm water. **Do not use soap.**

Leave the handle in position or the brew unit cannot be inserted properly.

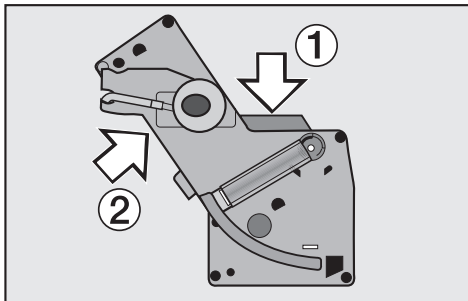

- Rub off any coffee residue from the filters with a sponge. One filter is in the funnel, ①, the second is to the left of the funnel, ②.
- Dry the funnel, ①, to prevent ground coffee from sticking.
- Clean the interior and remove coffee residues.

Dry coffee grounds can be vacuumed.

- Push the brew unit in the track straight into the appliance.

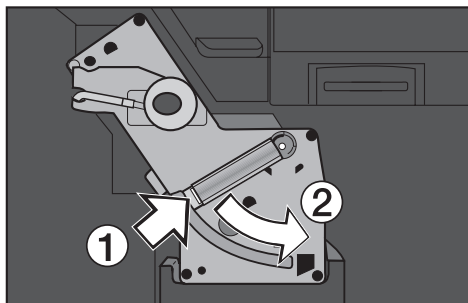

- Press the light colored button on the brew unit handle, ①, and turn the handle to the right, ②, to lock it into place.

Cleaning the brew unit

Depending on the oil content of the coffee, the brew unit can clog. Clean the brew unit approx. every 200 cups with the enclosed detergent tablets. They are specially developed for the coffee maker to optimize the degreasing. The cleaning tablets can be purchased from Miele.

As a reminder the display shows "Please run cleaning program" after 200 cups and then until the machine is cleaned. The cleaning process takes about 6 minutes.



- Tap < or > until "Maintenance" is highlighted, confirm with OK.
- Select "Clean brew unit", confirm with OK.
- Select "Start", confirm with OK.
- Follow the instructions in the display.

To avoid having to empty the drip tray too frequently, place the small cleaning container beneath the main dispenser. The inside of the machine is also rinsed, therefore you will still have to empty the drip tray when prompted during the cleaning process.

When the display prompts you to **Please drop the cleaning tablet in the ground coffee funnel.**

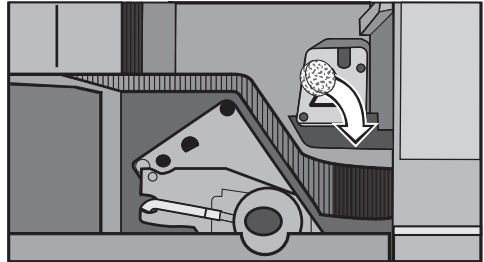

- Remove the storage drawer and open the funnel lid.
- Drop a cleaning tablet into the funnel.
- Close the lid, replace the drawer, and close the machine door.
- Follow the instructions in the display.
- When the display shows **Process finished**, tap OK.

The brew unit is now degreased, and the machine is ready for use.

Cleaning and care

Exterior

To avoid scratches or discoloration, immediately remove any soiling from the machine front.

- Turn off the machine using the On/Off button.
- The front of the appliance can be cleaned with a sponge and a solution of warm water and non abrasive liquid dish soap. Dry with a soft cloth.

Only use a slightly damp sponge when cleaning the controls. Water could penetrate into the electronics and cause damage.

The external surfaces of the coffee machine are susceptible to scratching. Scratches on the glass surface could also weaken the glass making it more susceptible to breakages.

Glass cleaners **may be used** to clean the exterior. However **do not** allow them to sit or "puddle", this can cause damage to the surface.
Remove the cleaner promptly.

To better maintain your appliance avoid the following:

- cleaners containing soda, ammonia, thinners, or chlorides
- cleaners containing descaling agents or lime removers,
- abrasive cleaners,
- stainless steel cleaners,
- caustic (oven) cleaners,
- scouring pads, steel wool, hard brushes,
- metal scrapers.

Wipe any spills from descaling immediately!

Descaling the appliance

The coffee system must be descaled regularly. The appliance will display a reminder message to descale and will eventually lock if not descaled.

The display will show "Please descale the coffee system. Remaining number of servings: 50". This message will now appear after each preparation.

- Tap OK to acknowledge this message.

If the counter has elapsed to 0, the appliance will be locked, and the display reads: **Please descale.**

- Tap OK to start the descaling cycle immediately.

Descaling takes about 20 minutes. If you want to continue at a later point in time, turn the unit off. The appliance can only be used again once descaling is performed.

The machine will automatically switch to water container operation for the descaling program.

Only use the **enclosed descaling tablets** for descaling. They are specially developed for the coffee system to optimize the descaling.

The descaling tablets can be purchased from Miele.

Other agents may damage the machine and affect the taste of coffee and hot water.

The machine could also be damaged.

Use the correct proportion of descaling agent in solution to prevent damage to the machine.

Use the supplied descaling funnel to protect the appliance front from the descaling agent. Clean up any **descaling spills** immediately to avoid damage to the appliance front.

Thoroughly clean the water tank and the drip tray of descaling residues.

Descaling the appliance

Descaling



- Tap < or > until "Maintenance  " is highlighted, confirm with OK.
- Select "Descale" and confirm with OK or, when the appliance is switched off, tap the OK button.
- Select "Start", tap OK to begin the descaling process.

The display prompts the user through the single steps of the descaling process. Follow the prompts.

If the descaling is started while the machine is still hot, the appliance will cool down for 10 minutes before the descaling begins.

The descaling process cannot be canceled once "OK" is selected. The process now needs to be completed. This is a safety feature to ensure the process will be completed. It is important for best results and the longevity of the machine.

To dissolve the descaling tablets:

- Remove the water tank and fill it up to the  mark with **lukewarm** water. (Do not **under-fill** the water tank, because this will cause the descaling cycle to end prematurely, before completion.)

- Add **2 descaling tablets** to the water and allow them to dissolve completely before closing the water tank and placing it back into the machine.

During the descaling cycle, the descaling agent-water solution will run out of the hot water spout and the main dispenser. This will be followed by a pause to allow the solution to dissolve the internal mineral buildup, after which more descaling solution will be released from the spouts. This process will repeat itself until the cycle is finished.

- When the display prompts you to **Add fresh water to tank**, rinse the tank thoroughly with clear water (all traces of descaling residue must be removed) and fill it with clean drinking water up to the k mark.

During rinsing, water will run out of the dispensing spouts. Because the inside of the machine is also rinsed out, you must **empty the drip tray** in the final step.

The machine is fully descaled when the display shows the message: **Descaling finished**. Follow the display prompts. The machine will perform a brief final rinse.

If the appliance was set to the plumbed water supply before descaling, once the descaling process is complete it will return to that setting.

Frequently asked questions

Repairs to electrical appliances should only be carried out by a suitably qualified person in accordance with local and national safety regulations. Repairs and other work by unqualified persons could be dangerous. The manufacturer cannot be held responsible for unauthorized work.

The light does not illuminate when the appliance is turned on.

Is the lighting turned off?

- See "Settings - Lighting".
If not, the lighting is defective.
Contact Miele.

The display remains dark.

The unit has no power.

- The main switch is turned off.
- The machine is not plugged in.
- Check that the fuse had not blown or is defective. If the fuse has blown contact Miele's Technical Service Department.

The unit suddenly turns off.

- Is the machine programmed to switch off after a programmed time?
- There could be pebbles within the coffee beans. The unit shuts off after 20 secs. to avoid damage.
- Is the machine plugged in?

- The machine goes into standby mode when not used for a programmed time. See "Settings - Timer - Switching off after".
- Contact Miele's Technical Service Department.
- Plug in the machine.

The light turns off suddenly.

The light turns off automatically when the machine has not been used for 15 minutes. See "Settings - Lighting".

Frequently asked questions

What if the machine does not switch on, even though the "Switch on at" timer setting is activated?	
The System Lock is activated.	See "Settings - System Lock".
The display messages are difficult to read.	
The contrast or brightness of the displays are too low / high.	Adjust the display contrast / brightness. See "Settings - Display".
No milk or milk froth comes out of the main dispenser.	
The dispenser is clogged.	See "Cleaning and Care".
The display prompts me to fill or insert the stainless steel milk container even though the container has already been filled and inserted	
The container needs to be cleaned.	See "Cleaning and Care".
The grinding sounds louder than usual.	
There could be pebbles within the coffee beans.	<ul style="list-style-type: none">– Turn off the unit immediately.– Contact the Miele's Tech. Service if the bean container is not empty. Otherwise fill the container with fresh beans.
The coffee/espresso flows too fast into the cup.	
The grind control is set too coarse.	Set the grind control slide to a finer grind.
The coffee/espresso flows too slow into the cup.	
The grind control is set too fine.	Set the grind control slide to a coarser grind.
The coffee/espresso is not hot enough.	
<ul style="list-style-type: none">– Were the supply lines and cup pre-heated?– The temperature is set too low.– Check if the brew unit is clogged.	<ul style="list-style-type: none">– The smaller the cup, the more important it is to pre-heat.– Check on what temperature range the coffee type is set.– Clean the brew unit.

Frequently asked questions

No drink is prepared although the beans were grinded and enough water is in the container.

- | | |
|--|---|
| <ul style="list-style-type: none">– The grind control is set to the finest or the amount of coffee is set to the maximum.– The process is timed, the process might need so long, there is no time for brewing any more. | <ul style="list-style-type: none">– Adjust the grind control slide to a different position, or the amount of coffee more or less. |
|--|---|

The door cannot be closed.

- | | |
|---|----------------------------------|
| <ul style="list-style-type: none">– Check if all containers are properly inserted.– The door hinges need to be adjusted. | See "Installation Instructions". |
|---|----------------------------------|

The steam heating system is turned off but steam can still dispensed.

Steam can be dispensed as long as the steam heating system is heated. Once it has cooled, steam can only be dispensed once the steam system has heated.

The coffee dispensing is interrupted.

The water tank is empty.	<p>If the unit is plumbed, check the water line and plumbing.</p> <p>If the unit is used with the water tank, refill the water tank with fresh cold tap water.</p> <p>You will be asked whether you would like the coffee dispensing to continue after the water tank has been filled. If you do not confirm with "OK" within 5 minutes the coffee preparation will be canceled.</p>
--------------------------	--

Frequently asked questions

Instead of coffee only water is dispensed.

- | | |
|---|--|
| <ul style="list-style-type: none">- The beans may have gotten stuck.- The ground coffee funnel cover was opened and closed and a preparation with ground coffee was selected but no ground coffee was inserted.
The coffee system switches automatically back to bean use after preparation. | <ul style="list-style-type: none">- Pull the bean container out and push it back in. |
|---|--|

The drip tray is empty but a message to empty it is displayed.

- | | |
|---|---|
| <ul style="list-style-type: none">- The metal contacts are soiled or wet.- Check if the drip tray is inserted correctly. | <ul style="list-style-type: none">- Clean and dry the contacts.- Insert the drip tray as described in "Cleaning and Care - Drip tray".- Turn the machine off and on again with the main switch.- If the message still appears contact Technical Service. |
|---|---|

The machine does not rinse when turned on although the automatic rinse feature is set to "On".

When the machine is still at a temperature of about 140°F (60°C). The machine will not rinse when it is too hot.

The water (or milk) dispensing stops when programming the serving size.

- | | |
|--|--|
| <ul style="list-style-type: none">- There was not enough water in the tank or milk in the milk container. The dispensed amount will not be saved.- If the maximum amount is dispensed, the flow stops automatically. The maximum amount is saved. | <ul style="list-style-type: none">- Fill the water tank or milk container before programming the serving size. |
|--|--|

Frequently asked questions

Water is in the waste unit.	
This is not a fault.	This is residual water from the cleaning process.
"Coffee water" is in the waste unit.	
If the grind setting is too coarse, this can result in too much coffee water in the waste unit.	Adjust the grind setting and/or amount of coffee.
The descaling process was started accidentally.	
The descaling process cannot be canceled once it is started. The process needs now to be completed. This is a safety feature to ensure the process will be completed. It is important for best results and the longevity of the machine. See "Descaling".	
The machine makes loud noises during descaling	
During a descaling cycle, the machine is relatively loud because water is being forced through the lines at high pressure. This is not a fault.	
The preheating time is increased, the water flow amount is not correct and the unit performs less?	
The machine needs to be descaled.	– See "Descaling the appliance". If the "Descale" reminder did not appear retest the water hardness to ensure that the machine is set correctly.
No water flows from the main dispenser.	
The filters in the brew unit are clogged.	Rub any residue off the filters with a sponge. See "Cleaning and Care".
The brew unit or waste unit could not be pulled from the machine.	
<ul style="list-style-type: none">– The brew unit is not in the correct position.– The door was opened during grinding or brewing.	<ul style="list-style-type: none">– Close the door. The brew unit automatically gets into the correct position.

Frequently asked questions

No crema has formed or it is "different".

- | | |
|---|--|
| <ul style="list-style-type: none">- Check if the grind setting is too coarse or too fine.- Check what temperature range the coffee type is set. If the temperature is too high, there are black areas in the crema.- Some coffee types produce too much crema when the coffee / espresso temperature is set to the maximum and the amount of ground coffee is too much. | <ul style="list-style-type: none">- Adjust the grind setting.- Lower the temperature and amount of ground coffee. See "Settings".- The coffee is not fresh enough.- The coffee is unsuitable for use in this machine.- The coffee dispensers are set too high. |
|---|--|

The message "Insert water tank until it engages" appears

- | | |
|-------------------------------|--|
| <p>No water is dispensed.</p> | <ul style="list-style-type: none">- The water tank is not inserted properly. Take it out and reinsert correctly.- The water tank was not filled correctly during the descaling process. Fill the water tank up to the correct mark.- If the message still appears contact Technical Service. |
|-------------------------------|--|

The message "Check water inlet" appears

- | | |
|--|---|
| <p>The plumbed water intake is faulty.</p> | <ul style="list-style-type: none">- Check for kinks in the water intake hose and open the water supply all the way.- Slide the water tank back in to the appliance.- If the fault is displayed again, call Technical Service. |
|--|---|

Frequently asked questions

The gasket of the coffee dispenser connector is damaged and leaking.

- The gasket is worn.
- Check the door. Is the alignment off from damage to the gasket?
- Change the gasket with a new one (supplied).
- Adjust the door hinges. See "Installation - Adjusting the door hinges".

Too much crema has formed and is above the coffee dispensers.

Some coffee types produce too much crema when the coffee / espresso temperature is set to the maximum and the amount of ground coffee is too much.

Lower the temperature and amount of coffee.

The grind control slide will not move.

Close the unit and prepare a coffee/espresso. The grind grade can now be reset.

The message "Fault - 73" appears in the display.

The brew unit is clogged and cannot reset to the correct position.

- Select "OK".
- Take out and clean the brew unit. See "Cleaning and Care - Brew unit".
- Reinsert the brew unit and close the door.
- If the message still shows contact Technical Service.

The message "Check brew unit" appears on the display?

Follow the display prompts.
Clean the brew unit (see "Cleaning and care" - "Brew unit").

Frequently asked questions

The message "Fault - 28" appears on the display?

If too much ground coffee passes through the coffee chute the machine is unable to process it.

– Tap the button next to OK.
The machine is again ready for use.

One of the messages "Fault - 1" to "Fault - 4" or "Fault - 80" to "Fault - 83" appears in the display.

Switch off the machine using the On/Off button and wait about one hour before switching it on again.

If the fault message appears in the display again, call Customer Service.

The message "Fault - 74" or "Fault - 77" appears in the display.

Turn the machine off and then on again after a short period of time.

If the fault message appears in the display again call Customer Service.

The storage drawer cannot be pushed in properly.

Close the lid of the ground coffee funnel.

The door is hard to open and close.

Adjust the door with the door hinges. See "Installation - Adjusting the door hinges".

You hear water gurgle or rushing.

The water tank has automatically filled.

In the event of a fault which you cannot easily fix yourself, please contact the Miele Technical Service Department at the contact information on the back of this booklet.

When contacting the Technical Service Department, please quote the model and serial number of your appliance given on the data plate inside the appliance.

MieleCare

(USA only)

MieleCare, our Extended Service Contract program, gives you the assurance of knowing that your appliance investment is covered by 5 years of worry free ownership.

MieleCare is the only Extended Service Contract in the industry that guarantees repairs by a Miele Authorized Service Provider using genuine Miele parts. Only genuine Miele parts installed by factory trained professionals can guarantee the safety, reliability, and longevity of your Miele appliance.

Please note that unless expressly approved in writing by Miele's Service department, Extended Service Contracts offered by other providers for Miele products will not be recognized by Miele. Our goal is to prevent unauthorized (and untrained) service personnel from working on your Miele products, possibly doing further damage to them, you and/or your home.

To learn more about **MieleCare** Extended Service Contracts, please contact your appliance dealer or visit us online at:

<http://miele.com/mielecare>

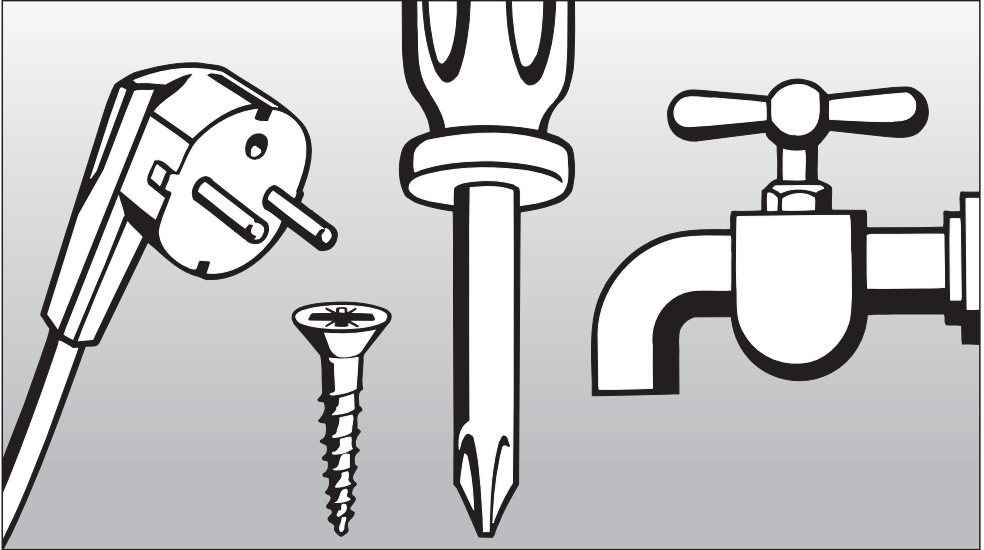

Installation instructions

Caring for the environment

Disposal of packing material

The cardboard box and packing materials protect the appliance during shipping. They have been designed to be biodegradable and recyclable. Please recycle.

Ensure that any plastic wrappings, bags, etc. are disposed of safely and kept out of the reach of children.
Danger of suffocation!

Disposal of an old appliance

Old appliances may contain materials that can be recycled. Please contact your local recycling authority about the possibility of recycling these materials.

Ensure that the appliance presents no danger to children while being stored for disposal. Before discarding an old appliance, unplug it from the outlet, cut off its power cord and remove any doors to prevent hazards.

The machine must be connected to the water supply in accordance with local and national regulations. The water being used should have the drinking water standards of the respective country where the machine is used.

- All units and systems used to deliver the water to the coffee system must conform with the requirements of the respective country.
- Only connect the machine to the cold water supply.
- The machine can be connected without a non-return valve.
- The on-site water line must have a water valve to turn the water off if needed. If not present, have a water valve installed by a licensed plumber.
- The water faucet must be accessible after installation.
- Water pressure on-site:
Minimum: 14.5 psi
Maximum: 145 psi, if higher, install a pressure reduction valve.
- Suitable 1/4" tubing or copper piping must be supplied for plumbing.
- To ensure the best coffee quality, the maximum length of the tubing or copper pipe should not exceed 4 ft. 11" (1.5 m). If too much water remains in the tubing the coffee quality could be affected.

Connection to the water supply

- Disconnect the machine from the electrical supply.
- Remove the water connection cover at the lower rear side of the coffee machine.

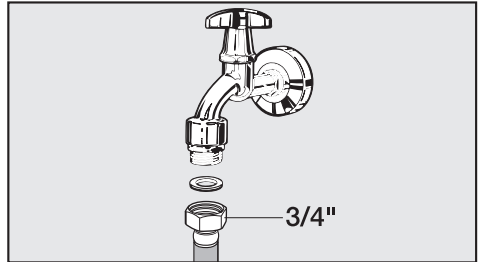

- Screw the supplied brass compression fitting, with the 3/4" end, tightly onto the water connector of the coffee machine. (Tighten the compression fitting by hand, do not use a tool.) The fitting includes an opening for standard 1/4" piping.
- Connect the compression fitting to the water supply.
- Check for leaks.

Electrical connection

Ensure that power is not supplied to the machine while installation or maintenance work is performed.

All electrical work should be performed by a qualified electrician in strict accordance with national and local safety regulations. Installation, repairs and other work by unqualified persons could be dangerous.

The manufacturer cannot be held responsible for unauthorized work.

Important

The coffee system comes equipped with a 6 ft (1.8 m) power cord with a NEMA 5-15P molded plug for connection to a 120 V, 15 A, 60 Hz power supply.

Verify that the voltage, load and circuit rating information found on the data plate match the household electrical supply before installing the coffee system.

If there is any question concerning the electrical connection of this appliance to your power supply, please consult a licensed electrician or contact Miele's Technical Service Department. See back page for contact information.

WARNING:
THIS APPLIANCE MUST BE
GROUNDED

Installation options

The coffee system is designed to be built into cabinetry.

Miele appliances can be installed flush or proud. Discuss your installation requirements with your architect, designer and installer.

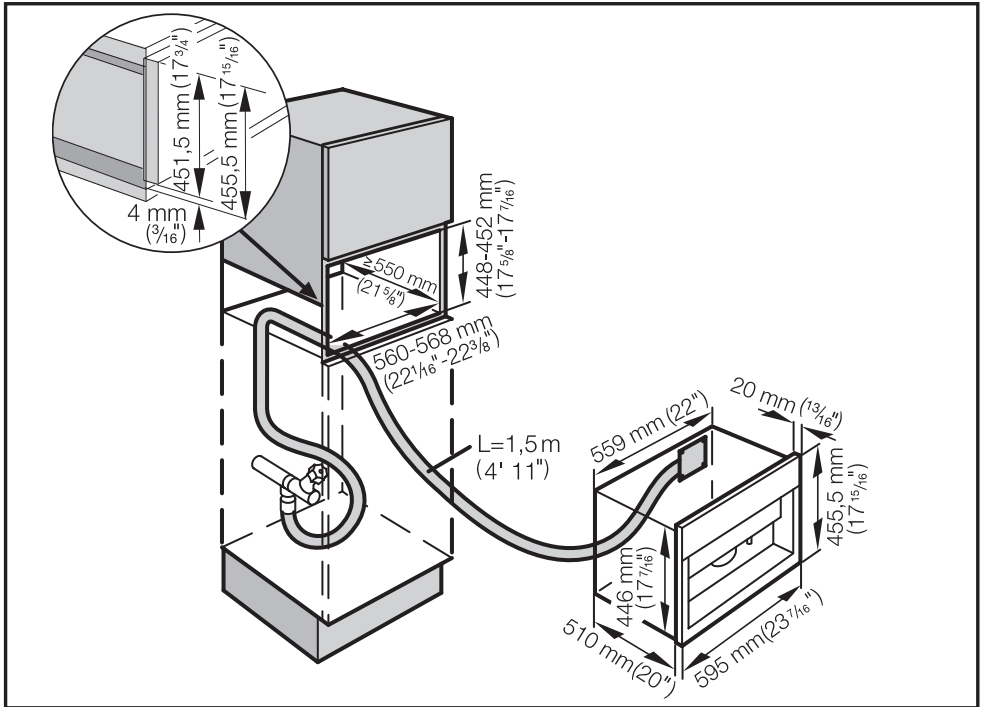

A combination with other Miele built in appliances is possible. If the machine is installed in combination with other appliances, it should be installed with a protective base between the appliance and the unit (exception: installation with a built-in plate warmer).

A special display cabinet is also available from your dealer or Miele, as an installation option.

Installation

Installation

Make sure power is not supplied to the appliance while installation or maintenance work is performed. Disconnect the power supply to the work area by unplugging the unit, tripping the circuit breaker or removing the fuse. The coffee system must be installed into cabinetry before being used. This unit should only be used in room temperatures ranging between 59 °F and 140 °F. Do not use the appliance outside of this range of temperatures

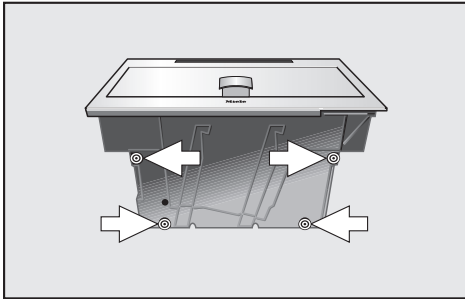

- Unscrew the height adjustable feet on the underside of the machine about 1/16" (2 mm).
- Push the appliance all the way back into the cabinet and center it. If necessary level the unit with the four height adjustable feet.

The feet can be turned out up to 3/8" (10 mm).

- If your cabinet has 3/4" (19 mm) side walls, drill four holes for the mounting.
- Center the unit and turn the screws a little bit in and then out again.
- Take the unit out of the niche and drill four holes at the screw markings (1/16" [2 mm], diameter 3/16" [4.5 mm]).
- Connect the water supply.
- Plug the appliance into the electrical outlet.
- Push the appliance into the niche.
- Open the door and partially tighten the screws.

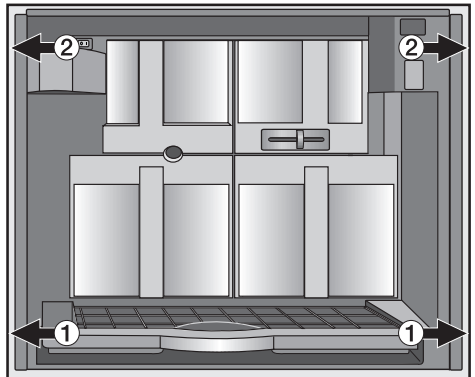

- Carefully turn the lower screws, ①, to center the machine.
- To secure the appliance in the cabinet, tighten the upper screws, ②, by hand. Do not use an electric screwdriver.

Adjusting the door hinges

The door hinges can be adjusted if the door cannot be opened easily.

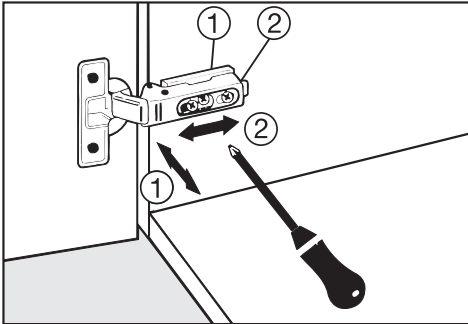

- To adjust the door sideways, ①, turn screw ①.
- To adjust the door to the front or back, ②, turn screw ②.

**Please have the model and serial number
of your appliance available before
contacting Technical Service.**



**U.S.A.
Miele, Inc.**

National Headquarters

9 Independence Way
Princeton, NJ 08540
Phone: 800-843-7231
609-419-9898
Fax: 609-419-4298
www.miele.com

**Technical Service & Support
Nationwide**

Phone: 800-999-1360
Fax: 888-586-8056
TechnicalService@mieleusa.com

**Canada
Miele Limited**

Headquarters and Showroom

161 Four Valley Drive
Vaughan, ON L4K 4V8
Phone: 800-643-5381
905-660-9936
Fax: 905-532-2290
www.miele.ca
info@miele.ca (general enquiries)
professional@miele.ca (commercial enquiries)

MieleCare National Service

Phone: 800-565-6435
905-532-2272
Fax: 905-532-2292
customercare@miele.ca (technical enquiries)

Alteration rights reserved / 0809

M.-Nr. 07 357 310 / 04

CVA 4066

For the most updated manual please see the Miele web site.