

# Honeywell

## Portable Evaporative Air Cooler User Manual (Web)

Read and save these instructions before use

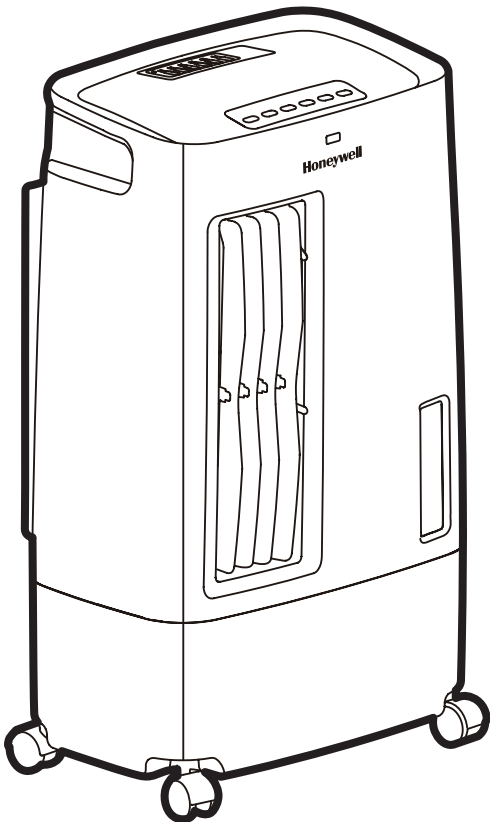

---

Model:  
CS071AE

---

# PARTS DESCRIPTION

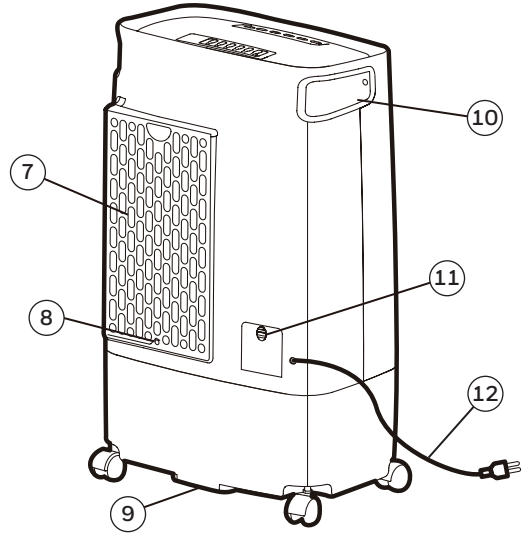
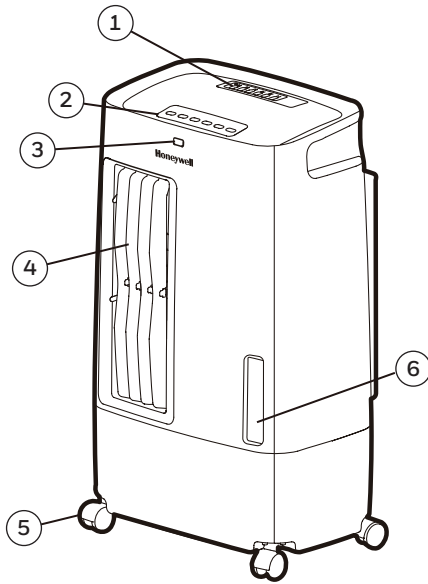

1) Remote Control

2) Control panel

3) Remote Control Receptor

4) Louvers

5) Casters

6) Water Level Indicator

7) Rear Grill

8) Rear Grill Screw

9) Drain Plug

10) Handle

11) Water Fill Door





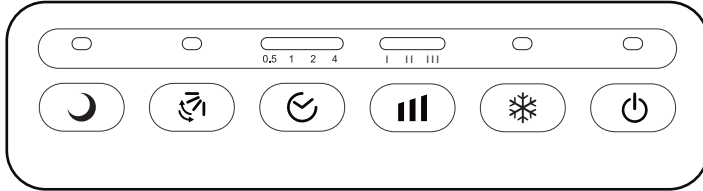

12) Power Cord & Plug

**WARNING -- READ AND SAVE THE AIR COOLER SAFETY & MAINTENANCE GUIDE AND USER MANUAL BEFORE USING THIS PRODUCT. FAILURE TO FOLLOW THESE INSTRUCTIONS MAY DAMAGE AND/ OR IMPAIR ITS OPERATION AND VOID THE WARRANTY. IN CASE THERE IS ANY INCONSISTENCY OR CONFLICT BETWEEN THE ENGLISH VERSION AND ANY OTHER LANGUAGE VERSION OF THE CONTENT OF THIS MATERIAL, THE ENGLISH VERSION SHALL PREVAIL.**

## CONTROL PANEL



### Icons on Control Panel

- |   |                |   |          |
|---|----------------|---|----------|
|  | Power On / Off |  | Speed    |
|  | Cool           |   | = Low    |
|  | Swing          |   | = Medium |
|  | Sleep*         |   | = High   |
|  | Timer Setting  |   |          |



\* Applicable for models with Sleep feature only.

## FUNCTION BUTTONS

### POWER

Press the  button to turn the unit on. The cooler will start automatically at medium speed. After a few seconds the speed will switch to low. To turn the unit off, press the button again.

### COOL

Please make sure water is added prior to setting the Cool Mode. Press the  button until the  indicator light is illuminated on the control panel. This activates evaporative cooling. The water pump will operate and you will feel the cooler air after the Honeycomb Cooling Media is completely wet. In COOL mode, unit may make a gargling sound when water level is below the minimum level mark. This is normal. Follow instructions to refill water tank with adequate water.

**Note:** When the  indicator light is switched OFF, the unit can still function in a fan only mode (without evaporative cooling). The Sleep\* function can still be switched on in a Fan only mode.



### SPEED

Press the  button repeatedly to change the speed between Ultra Low - Low - Medium - High - Turbo. The indicator light will show the selected speed.

### TIMER

Press the  button until the desired time duration setting is selected. When the set time has passed, the unit will automatically turn off (unit remains in Standby mode until power cord is unplugged from electrical socket). The TIMER function allows you to program the unit for up to 7.5 hours of use.

### SWING

Press the  button until the  indicator light is illuminated on the control panel. The louvers will begin to move left to right automatically.









### SLEEP\*

When SLEEP\* mode is selected, the fan speed will start running on Turbo Speed for one hour and then reduce one speed level every hour until it reaches Ultra Low speed. The fan will then remain at Ultra Low Speed until it is turned Off.

\* Applicable for models with Sleep feature only

## REMOTE CONTROL



|   |        |   |
|---|--------|---|
|  | POWER  | : ON / OFF                                      |
|  | SPEED  | : Ultra Low / Low / Medium / High / Turbo       |
|  | COOL   | : Evaporative cooling ON / OFF                  |
|  | SWING  | : Controls the motion of the louvers            |
|  | TIMER  | : Controls the Timer function for automatic off |
|  | SLEEP* | : Turn ON / OFF Sleep* mode                     |

\* Applicable for models with Sleep feature only

### NOTE:

- The remote control requires a CR2032(1 x 3V) coin type or equivalent battery for replacement. Open the battery compartment at the back of the remote control and insert the battery inside. Care must be taken to insert the batteries according to the correct polarity (+ / -) markings shown inside the battery compartment.
- Always point the remote control signal transmitter towards the unit when operating. Make sure that the signal path is not obstructed.
- Remove the batteries if the unit is not going to be used for an extended period of time.
- Do not drop the remote control.
- Do not mix different types of batteries such as alkaline, carbon-zinc, or rechargeable batteries.
- Do not mix old and new batteries.
- Do not recharge the battery.
- Exhausted batteries are to be removed from the product and safely disposed of as per local regulations.
- Do not dispose of batteries in fire. Batteries may explode or leak.
- This product contains a lithium button/coin cell battery. If a new or used lithium button/ coin cell battery is swallowed or enters the body, it can cause severe internal burns and can lead to death in as little as 2 hours. Always completely secure the battery compartment. If the battery compartment does not close securely, stop using the product, remove the batteries, and keep it away from children. If you think batteries might have been swallowed or placed inside any part of the body, seek immediate medical attention.
- The batteries shall be disposed of properly, including keeping them away from children.
- Even used batteries may cause injury.

 **WARNING:** Chemical Burn Hazard. Keep batteries away from children.

# USE & OPERATION (CONTINUED)

## COOLER LOCATION

Make sure to position the air cooler correctly before you set up and start using the product. Please refer to the COOLER LOCATION (IMPORTANT TO READ) section of the separate Safety & Maintenance Guide.

## FILLING WITH WATER

**CAUTION:** Unplug the unit from the electrical power outlet before emptying or refilling the water tank. Open the Water Fill Door.

Open the Water Fill Door located on the back of the unit.

The Water Level Indicator is located at the front of the unit. Refill the water tank when water level is low. Do not fill water above the "Max." water level mark to avoid water droplets collecting on the louvers. Check the water level in the tank before running the COOL function. Make sure that the water in the tank is above the minimum water level mark. Running the unit in COOL mode with inadequate water may cause pump failure.

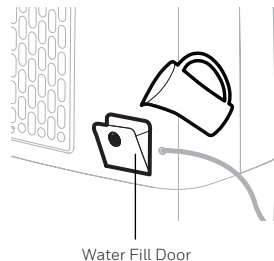

**Note:** The water capacity refers to the total volume of water that can be contained within the air cooler water tank and water distribution system. The water capacity in the tank at the "Max." indicator level may be lower than the actual water capacity of the air cooler.

**WARNING:** Do not fill water tank with dirty water or salt water. This can damage the unit and Honeycomb media.

## CLEANING & DRAINING THE WATER TANK

Below are instructions on how to clean and maintain your air cooler. If the cooler will not be used for a long period of time, please refer to the STORAGE & MAINTENANCE GUIDELINES located in the separate Safety & Maintenance Guide.

**WARNING:**

Before cleaning the unit, switch the unit OFF and disconnect from the electrical socket.

- Move the unit to a location where the water can be drained. Remove the cap from the drain plug located at the bottom of the unit. Allow the tank to empty.
- Refill the water tank with clean water, up to the maximum level and drain it completely.
- Use a damp cloth to remove the dirt and dust from the surface of the unit. Never use corrosive elements or chemicals to clean this product.
- When the product is not in use, store the unit in a dry place out of direct sunlight.

## CLEANING THE CARBON DUST FILTER\* AND HONEYCOMB COOLING MEDIA

### WARNING:

Before cleaning the unit, switch the unit OFF and disconnect the power adapter from the unit and electrical socket.

- The appliance is supplied with a Carbon Dust Filter\* and Honeycomb Cooling Media.
- The Carbon Dust Filter\* and Honeycomb Cooling Media are located inside the Rear Grill. See Figure 1 for instructions on how to remove them from the unit for cleaning and maintenance.
- Do not run the unit in COOL mode with stale water in the tank. You must empty the water tank and refill with fresh water, especially if the tank has not been cleaned in a long time.
- The cleaning frequency for the Honeycomb media depends on local air and water conditions. In areas where the mineral content of water is high, mineral deposits may build up on the Honeycomb Cooling Media and restrict air flow. Draining the water tank and refilling with fresh water at least once a week will help reduce mineral deposits. If mineral deposits remain on the Honeycomb Cooling Media, the media should be removed and washed under fresh water. The media should be cleaned every two months or sooner, depending on your needs.
- For best results allow the Honeycomb Cooling Media to dry after each use by turning off the cool function 15 minutes before turning the unit off.

### Removing the Carbon Dust Filter\* / Honeycomb Cooling Media:

1. Remove all the screws from the Rear Grill of the Air Cooler.
2. Carefully pull out the Rear Grill from the cooler.
3. Slide out the Carbon Filter\* and clean with water.
4. Pull out the Honeycomb Cooling Media.
5. Replace or clean media with water and a damp cloth as needed.

**WARNING:** DO NOT operate the Air Cooler when the Rear Grill is removed from the Air Cooler, or if there is a loose-fitting Rear Grill. Doing so can cause serious injury or dangerous electrical shock.

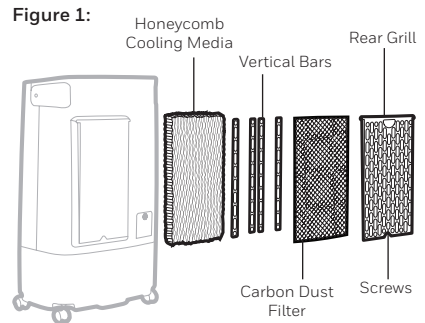

\* Applicable for models with Carbon Dust Filter only.