

# Table of Contents

<b>1 Description</b>	<b>10</b>
1.1 General Description	10
1.2 Cooktop	11
1.3 Control panel	11
1.4 Other parts	12
1.5 Available accessories	13
<b>2 Use</b>	<b>15</b>
2.1 Instructions	15
2.2 Using the accessories	17
2.3 Using the cooktop	20
2.4 Using the storage compartment	23
2.5 Using the main oven	23
2.6 Using the auxiliary oven	25
2.7 Cooking advice	26
2.8 Programming clock	27
<b>3 Cleaning and maintenance</b>	<b>32</b>
3.1 Instructions	32
3.2 Cleaning the hob	33
3.3 Cleaning the door	34
3.4 Cleaning the oven cavity	36
3.5 Extraordinary maintenance	39

## IMPORTANT SAFETY INSTRUCTIONS

**WARNING:** If the instructions contained in this manual are not followed precisely, fire or explosion may result causing property damage, personal injury or loss of life.

- Do not store or use gasoline or other flammable vapors or liquids near this or any other appliance.

### WHAT TO DO IF YOU SMELL GAS

- Do not try to light any appliance.
- Do not touch any electrical switches.
- Do not use any telephones in your building.
- Immediately call your gas supplier from a neighbor's phone. Follow the gas supplier's instructions.
- If you cannot reach your gas supplier, call the fire department.
- Installation and service must be performed by a qualified installer, service company or gas supplier.



## Important Safety Instructions

### TIP OVER HAZARD

#### WARNING



- A child or adult can tip the range and be killed.
- Make sure that the anti-tip device has been properly installed and attached. The wall-mounted brackets should anchor the sides of the range (primary system) or, in case of floor-mounted brackets, they should anchor the rear of the range to the ground.
- Make sure that the anti-tip device is re-attached when the range is moved. The wall-mounted brackets should anchor the sides of the range (primary system) or, in case of floor-mounted brackets, they should anchor the rear of the range to the ground.
- Do not operate the range without the anti-tip device in place and attached.
- Failure to do so can result in loss of life or serious burns to children or adults.



**READ AND SAVE THESE INSTRUCTIONS** - Your safety and the safety of others are very important.

We have provided many important safety messages throughout this manual and on the appliance.

Read all the instructions before using the appliance and always obey all safety messages.



### RECOGNIZE SAFETY INFORMATION

This is a safety alert symbol. This symbol alerts you to potential hazards that can result in severe personal injury or loss of life.

### UNDERSTAND SIGNAL WORDS

A signal word - DANGER, WARNING or CAUTION - is used with the safety alert symbol. DANGER denotes the most serious hazards. It means you could lose your life or be seriously injured if you do not immediately follow the instructions. WARNING means you could lose your life or be seriously injured if the instructions are not followed. CAUTION indicates a potentially hazardous situation which, if not avoided, could result in minor to moderate injury.

# Important Safety Instructions



EN

## WARNING



- This appliance is intended for use in the home only.
- Use this appliance only for its intended purpose. The manufacturer cannot be held liable for damage caused by improper use of this range.
- This appliance complies with current safety regulations. Improper use of this range can result in personal injury and material damage.
- Read all the instructions before installing or using the range for the first time.
- Keep these operating instructions in a safe place and pass them on to any future user.

The safety messages will inform you of potential hazards, on how to avoid the risk of injury and what can occur if the instructions are not followed.

**IMPORTANT: Observe all codes and ordinances in force.**



**NOTE:** This range is manufactured for use with natural gas. To convert the appliance to LP/Propane gas, see the instructions in the Gas Conversion Kit provided in the literature package.

The proper gas supply connection must be available. See "Gas supply requirements".

**WARNING: For your safety, the instructions contained in this manual must be followed to minimize the risk of fire or explosion and to prevent property damage, personal injury or loss of life.**

Do not store or use gasoline or other flammable vapors, liquids or materials near this or any other appliance.



**NOTE:** This range is NOT designed for installation in manufactured (mobile) homes or in recreational vehicles (RVs).

**DO NOT install this range outdoors.**

## WARNING



To reduce the risk of fire, electrical shock, personal injury, or damage when using the range, follow basic safety precautions, including the following:



## Important Safety Instructions

### WARNING



#### PRIMARY FASTENING SYSTEM:

Visually check that the wall-mounted brackets are inserted into the appropriate lateral hooks (on both sides).

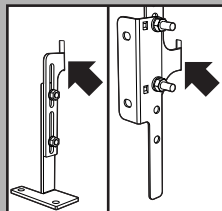

#### SECONDARY FASTENING SYSTEM:

Visually check from the inside of the drawer that the floor-mounted bracket is inserted into the appropriate lateral hooks (left or right).

- Proper installation is your responsibility. Make sure your appliance is properly installed and grounded by a qualified installer.
- **WARNING: NEVER** use this appliance as a space heater to heat or warm the room. Doing so may result in carbon monoxide poisoning and overheating of the oven.
- **DO NOT LEAVE CHILDREN UNATTENDED:** Children should not be left alone or unattended in the area where the appliance is being used. Never allow children to sit or stand on any part of the appliance.
- **CAUTION** - Do not store items of interest to children in cabinets above a range or on the backguard of a range - children climbing on the range to reach items could be seriously injured.
- **WEAR PROPER APPAREL:** loose-fitting or hanging garments should never be worn while using the appliance.
- For safety reasons and to avoid damage to your appliance, never sit, stand or lean on the oven door.
- **FLAMMABLE MATERIALS SHOULD NEVER BE STORED IN THE OVEN OR NEAR THE SURFACE BURNERS.**
- **GREASE IS FLAMMABLE:** Allow hot grease to cool before attempting to handle it. Do not allow deposits of grease to accumulate.
- **DO NOT USE WATER ON GREASE FIRES:** Turn the appliance off and smother the fire with baking soda or use a dry chemical or a foam-type extinguisher.
- **USE ONLY DRY POTHOLDERS:** Moist or damp potholders on hot surfaces may cause burns from steam. Do not allow potholders to touch hot surface burners. Do not use towels or other bulky cloth in place of potholders.
- Never allow garments, potholders or other flammable materials to come into direct or indirect contact with burners until they have completely cooled.

# Important Safety Instructions



- **DO NOT TOUCH SURFACE BURNERS OR THE INSIDE OF THE APPLIANCE:** Heating elements may be hot even though they are dark in color. The oven cavity can be hot enough to cause burns. During and after use, do not touch areas near burners or the inside of the oven until they have had sufficient time to cool. Do not allow garments or any flammable material to come into contact with hot surfaces. If personal clothing or hair catches on fire, drop and roll immediately to extinguish the flames.
- **PLACE THE OVEN RACKS IN THE DESIRED POSITION WHILE THE OVEN IS COOL:** If a rack must be removed while the oven is hot, do not allow the potholders to come in contact with the broiler burner.
- **USE CAUTION WHEN OPENING THE OVEN DOOR:** Allow hot air or steam to escape before removing or placing foods in the oven.
- Do not leave the packing materials around the home. Sort the various items of waste and take them to the nearest specialized waste collection facility.
- Do not obstruct oven vents or openings for air intake.
- **ELECTRICAL GROUNDING IS REQUIRED.** It is the customer's responsibility:
  - 1 To contact a qualified electrician.
  2. To ensure that the electrical system is adequate and in compliance with the National Electrical Code ANSI / NFPA 70 Electrical Code – latest edition – Or the CANADIAN ELECTRICAL CODE, C22.11 – 1982 and C22.2 No. 01982 – or latest edition – and all local codes and ordinances.
- Always check that the controls are in the "zero" (off) position when the range is not in use.
- Use only pots or pans with a perfectly smooth, flat bottom on the range surface burners. **NEVER USE THE RANGETOP AS A WORK SURFACE.**
- Do not attempt to repair or replace any part of this appliance unless specifically recommended in this manual. All other servicing should be done by a qualified technician.
- Never use any part of the range or oven for storage. Flammable materials can ignite and plastic items may melt or burst into flame.
- Do not hang articles on any part of the appliance or place anything against the oven. Some fabrics are extremely flammable and could ignite.
- **IMPORTANT:** After a spill or boilover, turn off the burner and clean around it. After cleaning, check that the burner functions properly.



## Important Safety Instructions

- DO NOT USE ALUMINUM FOIL TO LINE ANY PART OF THE OVEN OR RANGETOP. Use of a foil liner can result in an electrical shock or fire hazard or obstruct the flow of heat and air. Foil is an excellent heat insulator, allowing heat to be trapped under it. This can interfere with cooking and can damage the enamel of the oven.
- Prevent aluminum foil from contacting the heating elements.
- Never leave the range unattended when using high heat settings. Boilover can cause smoke and spattered grease can ignite.
- Not all types of glass, thermally resistant glass-ceramic, ceramic, earthenware, or other glazed cookware are suitable for range use. This type of cookware can break with sudden temperature changes. Use only on low or medium heat settings in accordance with the instructions supplied by the manufacturer.
- DO NOT HEAT UNOPENED FOOD CONTAINERS: A buildup of pressure can cause the containers to burst.
- DO NOT USE FLAMMABLE PRODUCTS TO CLEAN THE RANGE.
- Do not clean, rub, damage or remove the oven door gasket. It is essential for a good, tight seal during baking and when the self-clean cycle is engaged. Replace the oven door gasket if it becomes damaged or encrusted with food residue.
- Be sure all range surface burner controls are turned off and that the rangetop is cool before using any type of cleaning product. The chemical elements in these products could, in the presence of heat, ignite or cause metal parts to corrode.
- ONLY QUALIFIED SERVICE PERSONNEL SHOULD PERFORM REPAIRS. Service personnel must disconnect the power supply before servicing this unit.



**NOTE:** The California Safe Drinking Water and Toxic Enforcement Act requires the Governor of California to publish a list of substances known to the State of California to cause cancer, birth defects or other reproductive harm, and requires businesses to warn customers of potential exposure to such substances.

**WARNING:** This product contains a chemical known by the State of California to cause cancer, birth defects or other reproductive harm.

This appliance can cause low-level exposure to some of the substances listed, including benzene, formaldehyde, carbon monoxide, toluene, and soot.





# Important Safety Instructions





- Make sure that your range is properly secured and the anti-tip device is correctly installed. Refer to the instructions inside the installation manual.
- Do not stand or sit on the oven door or drawer.
- Remove all packing materials and temporary labels from the oven and rangetop.
- Record the Model and Serial number on Page 2 of this booklet. The Model and Serial numbers are on the Range ID plate. The ID Plates are visibly located on the back of the appliance and on the oven door frame. THE ID PLATE MUST NOT BE REMOVED.
- BEFORE BAKING OR BROILING FOR THE FIRST TIME, turn on the oven and broiler to burn off any dirt, oil or grease remaining from the manufacturing process. Turn the oven on and set to 450°F (230°C) for 20 to 30 minutes, then turn on the broiler for the same amount of time.

## How to read the user manual

This user manual uses the following reading conventions:

- Instructions**  
 General information on this user manual, on safety and final disposal.
- Description**  
 Description of the appliance and its accessories.
- Use**  
 Information on the use of the appliance and its accessories, cooking advice.
- Cleaning and maintenance**  
 Information for proper cleaning and maintenance of the appliance.

-  Safety instructions
-  Information
-  Advice

1. Use instruction sequence.
  - Single use instruction.

## SAVE THESE INSTRUCTIONS



# Description

## 1 Description

### 1.1 General Description

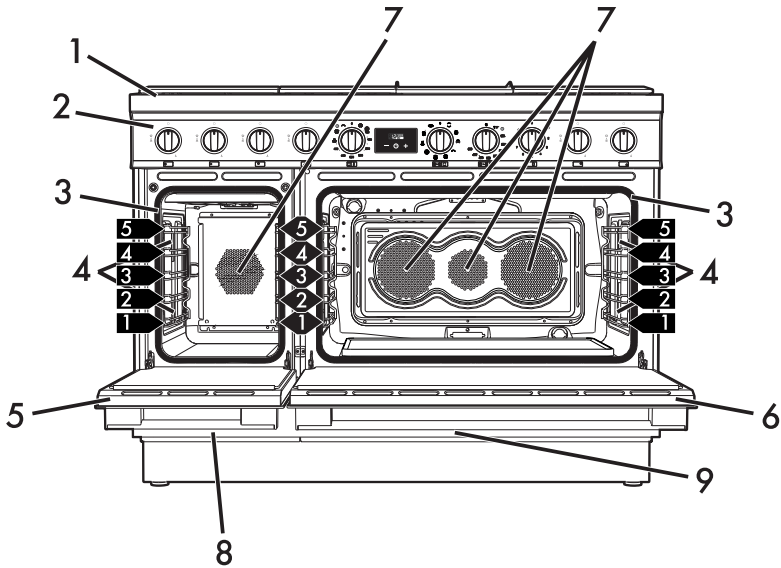

1 Cooktop

2 Control panel

3 Seal

4 Oven light

5 Small oven door

6 Main oven door

7 Fans

8 Small oven storage compartment

9 Main oven storage compartment

**1,2,3** → Rack/tray support frame shelf





## 1.2 Cooktop

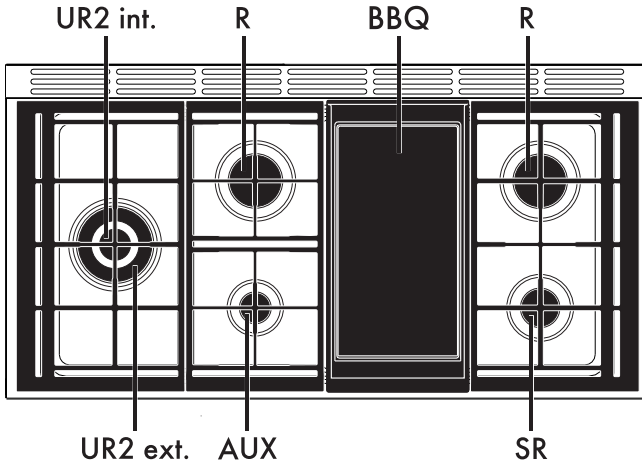



**AUX** = Auxiliary  
**R** = Rapid  
**SR** = Semi-rapid

**UR2 int.** = Ultra-rapid internal  
**UR2 ext.** = Ultra-rapid external  
**BBQ** = Barbecue plate

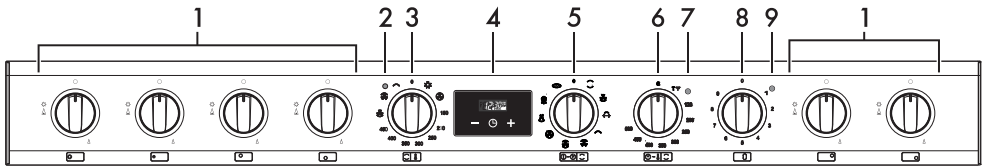
## 1.3 Control panel



### 1 Hob burner knobs

Useful for lighting and adjust the hob burners. Press and turn the knobs anti-clockwise to the value  to light the relative burners. Turn the knobs to the zone between the maximum  and minimum  setting to adjust the flame.

Return the knobs to the  position to turn off the burners.

### 2 Auxiliary oven pre-heating indicator light

The pre-heating indicator light comes on to indicate that the oven is pre-heating up. It turns off as soon as it reaches the set temperature.

It flashes regularly to indicate that the temperature set inside the oven is kept constant.



## Description

### 3 Auxiliary oven function/temperature knob

The oven's various function are suitable for different cooking models. The cooking temperature is selected by turning the knob clockwise to the required setting, between **120°F** and **450°F**

### 4 Programming clock

Useful for displaying the current time, set programmed cooking operations and program the timer.

### 5 Main oven function knob

The oven's various functions are suitable for different cooking modes. After selecting the required function, set the cooking temperature using the temperature knob.

### 6 Main oven temperature knob

This knob allows you to select the cooking temperature. Turn the knob clockwise to the required value, between **120°F** and **500°F**.

### 7 Main oven pre-heating indicator light

The pre-heating indicator light comes on to indicate that the oven is pre-heating up. It turns off as soon as it reaches the set temperature.

It flashes regularly to indicate that the temperature set inside the oven is kept constant

### 8 Barbecue knob

Adjusts the power of the barbecue element on the hob.

Turn the knob to any position from **1** to **9** to activate the heating element.

### 9 Barbecue indicator light

Turns on to indicate that the barbecue heating element is on. It turns off as soon as it reaches the set temperature. It flashes regularly to indicate that the temperature set for the element is kept constant.

## 1.4 Other parts

### Interior lighting

The appliance's interior lighting comes on:

- When the door is opened.
- When any function is selected.



When the door is open, it is not possible to turn off the interior lighting.

### Shelves

The appliance features shelves to position trays and racks at different heights. The insertion heights are indicated from the bottom upwards (see 1.1 General Description).



## Cooling fan

The fan cools the oven and comes into operation during cooking.

The fan causes a steady outflow of air that exits from the rear of the appliance and which may continue for a brief period of time even after the appliance has been turned off.

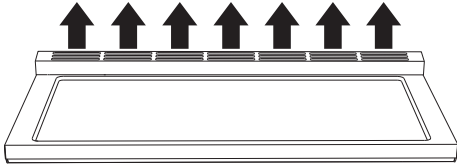

Do not obstruct ventilation openings and heat dispersal slots.

## 1.5 Available accessories

### Teppanyaki plate

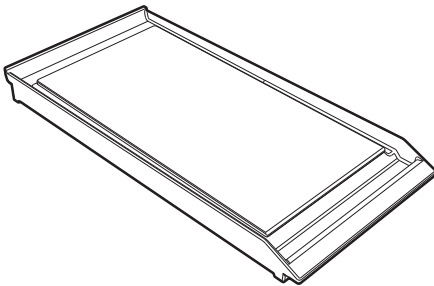

Useful for cooking meat, fish and vegetables directly on the plate without adding fats or oils, staying true to the tradition of Japanese cuisine that seeks to exalt the natural flavours and aromas of food ensuring light nourishment while preserving all nutritional elements.

### Griddle

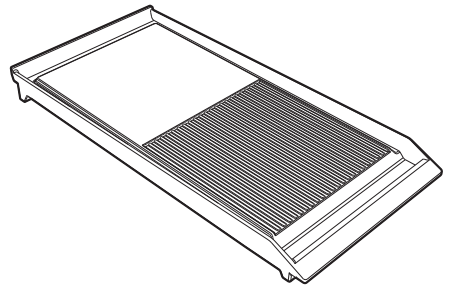

Useful for grilling, gratinating or barbecue cooking, seeking to exalt the natural flavours and aromas of food ensuring light nourishment while preserving all nutritional elements.

### WOK ring

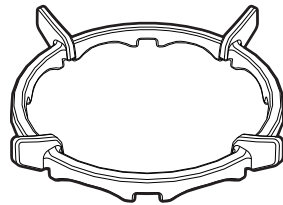

Useful when using a wok.

### Oven tray

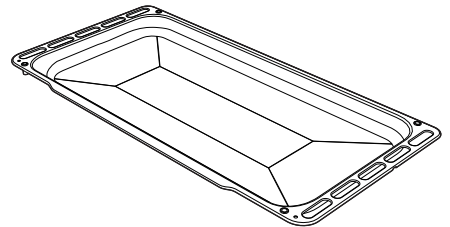

Useful for collecting fat from foods placed on the rack above.



## Description

### Rack

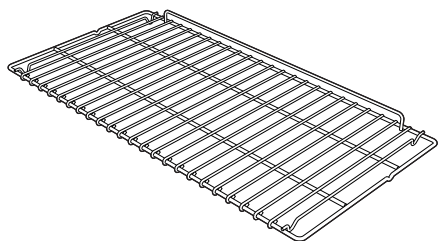

Useful for supporting containers with food during cooking.

### Rotisserie

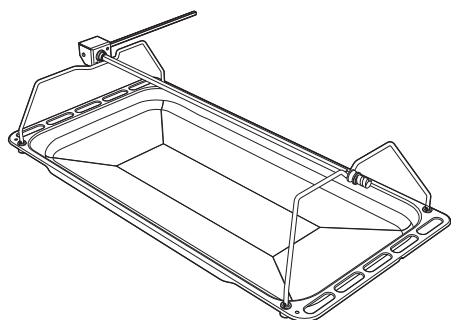

Useful for cooking chicken and all foods which require uniform cooking over their entire surface.

### Tray rack

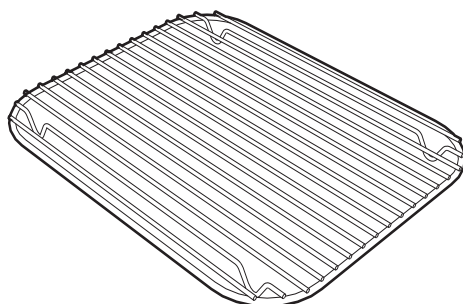
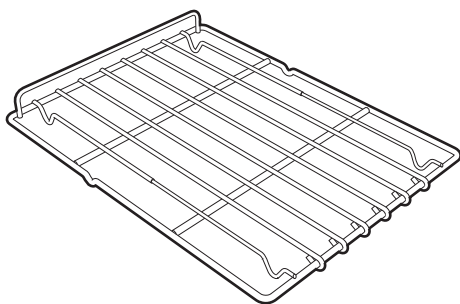

This is placed above the oven tray, and is used for cooking foods that might drip.



Some models are not provided with all accessories.



The accessories intended to come into contact with food are made of materials that comply with the provisions of current legislation.



Supplied and optional accessories can be requested to Authorised Assistance Centres. Use only original accessories supplied by the manufacturer.



## 2 Use

### 2.1 Instructions



#### High temperature inside the oven during use Danger of burns

- Keep the oven door closed during cooking.
- Protect your hands by wearing oven gloves when moving food inside the oven.
- Do not touch the heating elements inside the oven.
- Do not pour water directly onto very hot trays.
- Keep children under the age of 8 away from the appliance when it is in use.
- If you need to move food or at the end of cooking, open the door 5 cm for a few seconds, let the steam come out, then open it fully.



#### Improper use Danger of burns

- Make sure that the flame-spreader crowns are correctly positioned in their seats with their respective burner caps.
- Oils and fats could catch fire if overheated. Be very careful.



#### Improper use Risk of damage to surfaces

- Do not cover the bottom of the oven cavity with aluminium or tin foil sheets.
- If you wish to use greaseproof paper, place it so that it will not interfere with the hot air circulation inside the oven.
- Do not place pans or trays directly on the bottom of the oven cavity.
- Do not use the open door to rest pans or trays on the internal glass pane.
- Do not pour water directly onto very hot trays.
- Cooking vessels or griddle plates should be placed inside the perimeter of the hob.
- All pans must have smooth, flat bottoms.
- If any liquid does boil over or spill, remove the excess from the hob.



#### High temperature inside the storage compartment Danger of burns

- Do not open the storage compartment when the appliance is on and still hot.
- The items inside the storage compartment could be very hot after using the appliance.



High temperature inside the oven during use

## Danger of fire or explosion

- Do not spray any spray products near the appliance.
- Do not use or leave flammable materials near the appliance or the storage compartment.
- Do not use plastic cookware or containers when cooking food.
- Do not put sealed tins or containers in the oven.
- Do not leave the appliance unattended during cooking operations where fats or oils could be released.
- Remove all trays and racks which are not required during cooking.

## A gas leak can cause an explosion.

If you smell gas or there are faults in the gas system:

- Immediately turn off the gas supply or close the valve on the gas cylinder.
- Extinguish all naked flames and cigarettes.
- Do not turn on power switches or appliances and do not remove plugs from power sockets. Do not use phones or mobile phones inside the building.
- Open the window in order to ventilate the room.
- Call customer assistance services or your gas supplier.

## Malfunctions

Any of the following indicate a malfunction and you should contact a service centre.

- Yellowing of the burner plate.
- Damage to kitchen utensils.
- The burners do not ignite properly.
- It is difficult to keep the burners lit.
- The burners go out when the appliance is in use.
- It is difficult to turn the gas valves.

If the appliance does not work properly, contact your local Authorised Service Centre.

## First use

1. Remove any protective film from the outside or inside of the appliance, including accessories.
2. Remove any labels (apart from the technical data plate) from the accessories and from the oven cavity.
3. Remove and wash all the appliance accessories (see 3 Cleaning and maintenance).
4. Heat the empty appliance to the maximum temperature to burn off any residues left by the manufacturing process.



## 2.2 Using the accessories

### Barbecue griddle



High temperature  
Burn hazard

- After extended use the cooking plate will stay hot even after the heater element has switched off. Keep children at a distance.
- Remove the griddle only when it is cold.

Useful for grilling, gratinating or barbecue cooking.

1. Before cooking, remove the barbecue griddle.
2. Lift the heater element **A** and lock it with the suitable catch **B**.

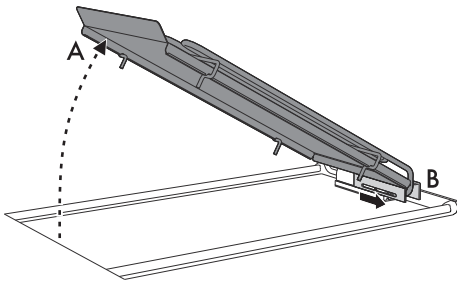

3. In the tray under the heater element you can place:
  - Water to gather fat and oil coming from cooking.
  - Molten rock to keep heat longer and improving cooking times and quality.
4. Remove the catch of the heater element **B** and lower it so that the four references lie on the bottom of the tray.

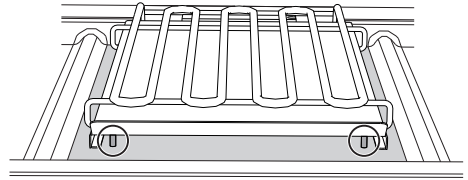

Pay attention not to go beyond the edge of the tray.

5. Reposition the griddle on the hob.
6. Rotate the barbecue heater element knob to a position ranging between **1** and **9**. The indicator light comes on to indicate that the heater element is in use.



It is advisable to preheat the barbecue heater element for 5-6 minutes before positioning the food.



## Ring reducers

The ring reducers must be placed on the hob grids. Make sure they are placed properly.

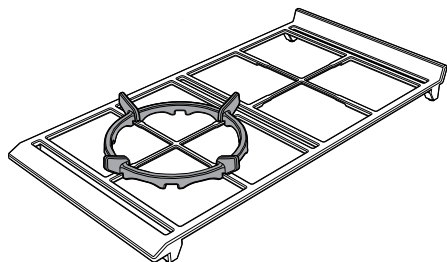

## Racks and trays

Racks and trays have to be inserted into the side guides until they come to a complete stop.

The mechanical safety locks that prevent the rack from being taken out accidentally have to face downwards and towards the oven back.

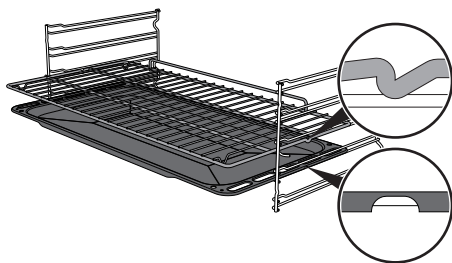

## Rotisserie

1. Insert the 4 supplied bushings in the 4 corner holes of the deep tray and screw them onto the ring nuts with a suitable tool (such as a screwdriver).

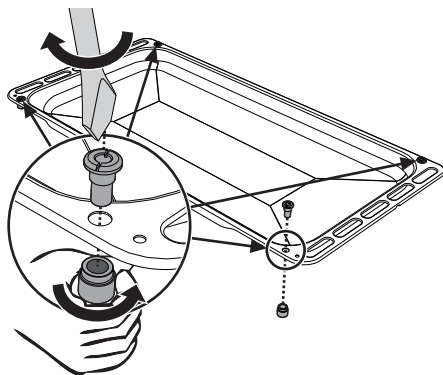

2. Position the rotisserie supports in the bushings as shown in the figure below.

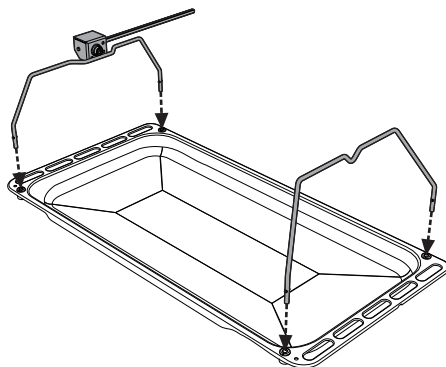

Gently insert racks and trays into the oven until they come to a stop.



Clean the trays before using them for the first time to remove any residues left by the manufacturing process.





3. Prepare the rotisserie rod with the food using the clip forks provided. The clip forks can be tightened using the fastening screws.

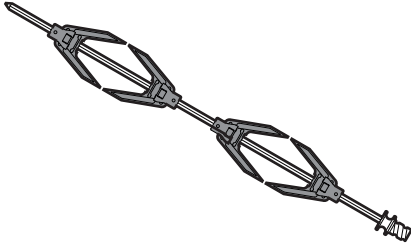

4. Once you have prepared the rotisserie rod, place it on the supports. Insert the tip of the rod in the housing of the mechanism on the left-hand support until it stops.

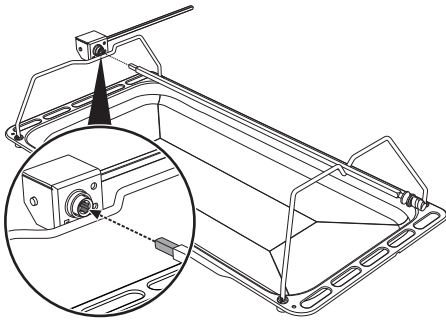

5. Place the tray on the first runner (see "General Description").
6. Insert the tip of the rod in the rotisserie motor housing on the left of the rear wall of the oven.

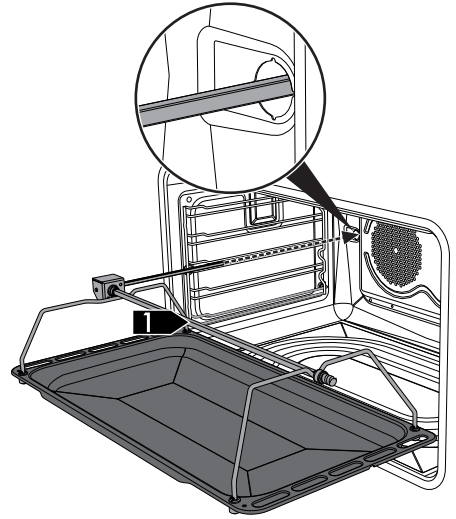

These operations must be performed with the oven off and cold.



## Use

7. To activate the rotisserie, turn the function knob to select the  function and use the temperature knob to set a cooking temperature.



Pour a little water into the tray to prevent smoke from forming.

8. When cooking is complete, remove the tray with the rotisserie.
9. Screw on the handle provided so that you can handle the rotisserie rod more easily.

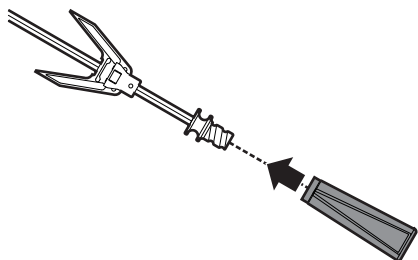

### 2.3 Using the cooktop



#### WARNING FIRE HAZARD

- For your safety: do not allow the burner flame to extend beyond the edge of the pan.

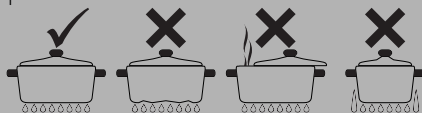

- Turn off all controls when the range is not in use.

All the appliance's control and monitoring devices are located together on the front panel. The burner controlled by each knob is shown next to the knob. The appliance is equipped with an electronic ignition device. Simply press the knob and turn it counter-clockwise to the maximum flame symbol, until the burner lights. If the burner does not light in the first 15 seconds, turn the knob to  and wait 5 minutes before trying again. After lighting, keep the knob pressed in for a few seconds to allow the thermocouple to heat up. The burner may go out when the knob is released: in this case, the thermocouple has not heated up sufficiently. Wait a few moments and repeat the operation. Keep the knob pressed in longer.



In case of an accidental turning off, a safety device will be tripped, cutting off the gas supply, even if the gas tap is open. Return the knob to  and wait at least 5 minutes before lighting it again.



## Simmer function

**i** This function is extremely useful for melting food like butter, chocolate or similar and for simmering small quantities of food.

1. Switch on the DUAL burner internal cup.
2. Set the flame to the minimum.
3. Leave the external cup off.

 If the external cup switches on at full power, set half power at least for the internal cup.

## Correct positioning of the flame-spreader crowns and burner caps

Before lighting the hob burners, make sure that the flame-spreader crowns are correctly positioned in their seats with their respective burner caps. Make sure that the holes **1** of the flame-spreader crowns are aligned with the thermocouples **2** and igniters **3**.

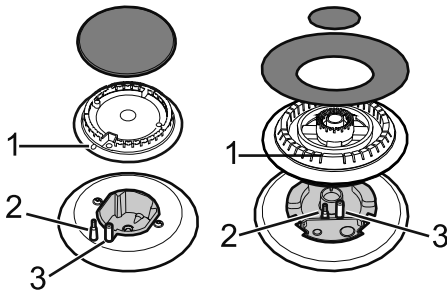

## Practical tips for using the hob

For better burner efficiency and to minimise gas consumption, use pans with lids and of suitable size for the burner, so that the flames do not reach up the sides of the pan. Once the contents come to the boil, turn down the flame far enough to ensure that the liquid does not boil over.



Cookware diameters:

- **AUX:** 12 - 14 cm.
- **SR:** 16 - 24 cm.
- **R:** 18 - 26 cm.
- **UR2 int + ext.:** 18 - 28 cm.

## Cookware

Ideally, cookware should have a flat bottom, straight sides, a tight-fitting lid and medium-to-heavy thickness.

Rough cookware finishes may scratch the rangetop. Aluminum and copper may be used in cookware as a core material or base. However, when used as a base they can leave permanent marks on the rangetop or grates.

Cookware properties are a factor in how quickly and evenly heat is distributed, which affects cooking results. A non-stick finish has the same characteristics as its base material. For example, a non-stick finish on aluminum cookware will take on the properties of aluminum.



## Use

Refer to the following chart as a guide to the physical properties of cookware.

### Aluminum

- Heats quickly and evenly.
- Suitable for all types of cooking.
- Medium or heavy thickness is best for most cooking tasks.

### Cast iron

- Heats slowly and evenly.
- Good for browning and frying.
- Maintains heat for slow cooking.

### Ceramic or glass-ceramic

- Follow the manufacturer's instructions.
- Heats slowly but unevenly.
- Best results with low to medium heat settings.

### Copper

- Heats very quickly and evenly.

### Earthenware

- Follow the manufacturer's instructions.
- Use low heat settings.

### Porcelain enameled steel or cast iron

- See stainless steel or cast iron.

### Stainless steel

- Heats quickly but unevenly.
- Stainless steel cookware with aluminum or copper as a core material or bottom provides even heating.

### Correct positioning of the hob grids

Before lighting the hob burners, make sure that the grids are correctly positioned on the hob.

Bear in mind that:

- Each grid has its own position on the hob.
- The raised section must always face the appliance's upstand.

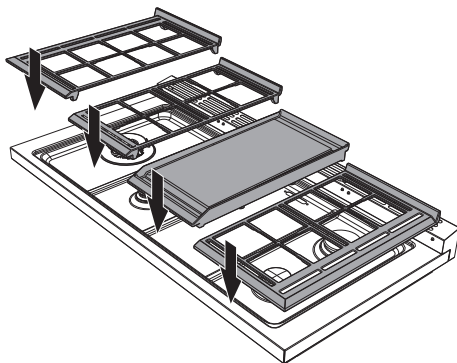

- The left-hand (**A**) and right-hand (**C**) grids have one thicker edge which must be turned to face the side of the appliance.
- The edges of the centre grid (**B**) are of the same thickness.

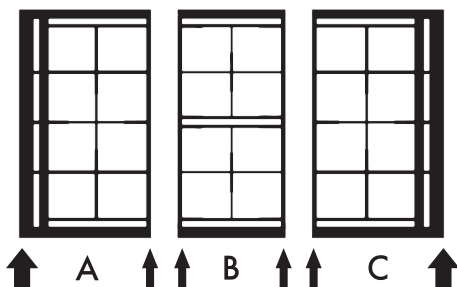



## 2.4 Using the storage compartment

There is a storage compartment located at the bottom of the cooker; this can be used to store pans or metal objects required for its use.

1. To open the storage compartment, pull lightly the door.

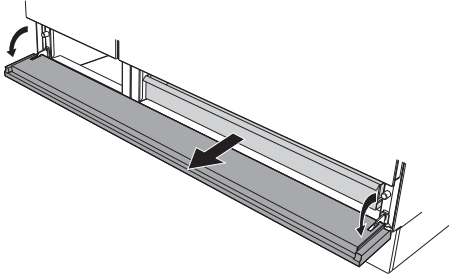

2. Gently release the storage compartment door.
3. To close the storage compartment again, lift the door until it's closed.

## 2.5 Using the main oven

### Switching on the main oven

To switch the oven on:

1. Select the cooking function using the function knob.
2. Select the temperature using the temperature knob.

**i**

Ensure that the programmer clock shows the cooking duration symbol , otherwise it will not be possible to turn on the oven.

Press the key  to reset the programmer clock.

### Functions list



#### Static

As the heat comes from above and below at the same time, this system is particularly suitable for certain types of food. Traditional cooking, also known as static cooking, is suitable for cooking just one dish at a time. Perfect for all types of roasts, bread and cakes and in any case particularly suitable for fatty meats such as goose and duck.



## Use



### Fan-assisted bottom

The combination of the fan with only the bottom heating element allows cooking to be completed more rapidly. This system is recommended for sterilizing or for finishing off the cooking of foods already well-cooked on the surface, but not inside, which therefore need a little more heat. Perfect for any type of food.



### Rotisserie grill

The rotisserie works in combination with the grill element allowing food to be perfectly browned.



### Grill

The heat coming from the grill element gives perfect grilling results above all for thin and medium thickness meat and, in combination with the rotisserie (where fitted), gives the food an even browning at the end of cooking. Perfect for sausages, spare ribs and bacon. This function enables large quantities of food, particularly meat, to be grilled evenly.



### Fan with grill

The air produced by the fan softens the strong heatwave generated by the grill, grilling perfectly even very thick foods. Perfect for large cuts of meat (e.g. shin of pork).



### Fan assisted

The operation of the fan, combined with traditional cooking, ensures consistent cooking even with complex recipes. Perfect for biscuits and cakes, even when simultaneously cooked on several levels. (For multiple-level cooking, we recommend using the 2<sup>nd</sup> and 4<sup>th</sup> shelves).



### Fan with circulaire

The combination of the fan and the circulaire heating element (incorporated in the rear of the oven) allows you to cook different foods on several levels, as long as they need the same temperatures and same type of cooking. Hot air circulation ensures instant and even distribution of heat. It will be possible, for instance, to cook fish, vegetables and biscuits simultaneously (on different levels) without odours and flavours mingling.



### Lower element

The heat coming just from the bottom allows you to complete the cooking of foods that require a higher bottom temperature, without affecting their browning. Perfect for cakes, pies, tarts and pizzas.



### Rapid defrost

Rapid defrost is helped by switching on the fan provided and the top heating element that ensure uniform distribution of low temperature air inside the oven.



### Pizza

The operation of the fan, combined with the grill and the lower heating element, ensures uniform cooking even with complex recipes. Perfect not just for pizzas, but also for biscuits and cakes.



### Fan-assisted bottom

The combination of the fan with only the bottom heating element allows cooking to be completed more rapidly. This system is recommended for sterilizing or for finishing off the cooking of foods already well-cooked on the surface, but not inside, which therefore need a little more heat. Perfect for any type of food.



### Fan with grill

The air produced by the fan softens the strong heatwave generated by the grill, grilling perfectly even very thick foods. Perfect for large cuts of meat (e.g. shin of pork).



### Grill

The heat coming from the grill element gives perfect grilling results above all for thin and medium thickness meat and, in combination with the rotisserie (where fitted), gives the food an even browning at the end of cooking. Perfect for sausages, spare ribs and bacon. This function enables large quantities of food, particularly meat, to be grilled evenly.

## 2.6 Using the auxiliary oven

### Switching on the auxiliary oven

To switch the oven on:

- Select the cooking function using the function/temperature knob.

### Functions list



### Fan with circulaire

The combination of the fan and the circulaire heating element (incorporated in the rear of the oven) allows you to cook different foods on several levels, as long as they need the same temperatures and same type of cooking. Hot air circulation ensures instant and even distribution of heat. It will be possible, for instance, to cook fish, vegetables and biscuits simultaneously (on different levels) without odours and flavours mingling.



## 2.7 Cooking advice



### General advice

- Use a fan-assisted function to achieve uniform cooking at several levels.
- It is not possible to shorten cooking times by increasing the temperature (the food could be overcooked on the outside and undercooked on the inside).
- Using more ovens at the same time might affect the final cooking results.

### Advice for cooking meat

- Cooking times vary according to the thickness and quality of the food and to consumer taste.
- Use a meat thermometer when roasting meat, or simply press on the roast with a spoon. If it is hard, it is ready; if not, it needs another few minutes cooking.

### Advice for cooking with the Grill and the Fan-assisted grill

- Meat can be grilled even when it is put into the cold oven or into the preheated oven if you wish to change the effect of the cooking.
- With the Fan-assisted grill function, we recommend that you preheat the oven before grilling.
- We recommend placing the food at the centre of the rack.
- With the Grill  and Small grill  functions, we recommend that you turn the temperature knob to the maximum value to optimise cooking.

- Foods should be seasoned before cooking. Foods should also be coated with oil or melted butter before cooking.
- Use the oven tray on the first bottom shelf to collect fluids produced by grilling.
- Grilling processes should never last more than 60 minutes using multifunction ovens, 30 minutes inside the auxiliary oven.

### Advice for cooking desserts and biscuits

- Use preferably dark metal moulds: they help to absorb the heat better.
- Temperature and cooking time depend on the quality and consistency of the dough.
- To check whether the dessert is cooked right through: at the end of the cooking time, put a toothpick into the highest point of the dessert. If the dough does not stick to the toothpick, the dessert is cooked.
- If the dessert collapses when it comes out of the oven, on the next occasion reduce the set temperature by about 50°F, selecting a longer cooking time if necessary.
- While cooking desserts or vegetables, excessive condensation may form on the glass. In order to avoid this, open the door very carefully a couple of times while cooking.





### Advice for defrosting and proving

- Place frozen foods without their packaging in a lidless container on the first shelf of the oven.
- Avoid overlapping the food.
- To defrost meat, use the rack placed on the second level and a tray on the first level. In this way, the liquid from the defrosting food drains away from the food.
- The most delicate parts can be covered with aluminium foil.
- For successful proving, a container of water should be placed in the bottom of the oven.

### To save energy

- Stop cooking a few minutes before the time normally used. Cooking will continue for the remaining minutes with the heat which has accumulated inside the oven.
- Reduce any opening of the door to a minimum to avoid heat dispersal.
- Keep the inside of the appliance clean at all times.

## 2.8 Programming clock



The programming clock only works for the main oven.



Value decrease key



Clock key



Value increase key



Ensure that the programmer clock shows the cooking duration symbol , otherwise it will not be possible to turn on the oven.

Press the key  to reset the programmer clock.







## Use



### Setting the time

**i** If the time is not set, the oven will not switch on.

On the first use, or after a power failure, the digits  will be flashing on the appliance's display.

1. Keep the clock key  for two seconds. The dot between the hours and the minutes flashes.
2. The time can be set via the value increase key  and value decrease key . Keep the key pressed in to increase or decrease rapidly.
3. Wait 7 seconds. The dot between the hours and the minutes stops flashing.







The symbol  on the display indicates that the appliance is ready to start cooking.

 To change the time, hold down the value increase key  and value decrease key  at the same time for two seconds, then set the time.

### Minute minder timer

**i** The minute minder timer does not stop the cooking operation but rather informs the user when the set time has run out.

The minute minder timer can be activated at any time.









1. Keep the clock key  pressed for a few seconds. The display shows the figures  and the symbol  flashing between the hours and minutes.
2. Use the value increase  and value decrease  keys to set the number of minutes required.
3. Wait approx. 5 seconds without pressing any key to finish setting the minute minder. The current time and the symbol  appear on the display.
4. A buzzer will sound when the set time is reached.
5. Press the value decrease key  to turn the buzzer off.

**i** The minute minder timer can be set from 1 minute to a maximum of 23 hours and 59 minutes.





## Timed cooking



**i** Timed cooking is the function which allows a cooking operation to be started and then ended after a specific length of time set by the user.

1. Keep the clock key  pressed for a few seconds. The display shows the figures  and the symbol  flashing between the hours and minutes.
2. Press the clock key  again. On the display the digit  appear alternating with the digit  and the symbol  flashing under the minutes.
3. Use the value increase  and value decrease  keys to set the required minutes of cooking.
4. Select a function and a cooking temperature.

5. Wait approx. 5 seconds without pressing any key in order for the function to activate. The current time and the symbol **auto** will appear on the display.

- At the end of cooking the heating elements will be deactivated. On the display, the symbol  turns off, the symbol **auto** flashes and the buzzer sounds.
6. To turn the buzzer off, simply press one of the programmer clock keys.
  7. Press the clock key  to reset the programmer clock.

**i** It is not possible to set a cooking time of more than 10 hours.

 To cancel the set programming press and hold down the value increase  and the value decrease  keys at the same time and then turn the oven off manually.



## Programmed cooking

**i** Programmed cooking is the function which allows a cooking operation to be started at a set time and then ended after a specific length of time set by the user.

1. Set the cooking time as described in the previous point "Timed cooking".
2. Press the clock key again. On the display the digit **End** appear alternating with the current time digit **11:30** and the symbol **auto** flashing under the minutes.
3. Use the value increase and value decrease to set the cooking end time.
4. Select a function and a cooking temperature.
5. Wait approx. 5 seconds without pressing any key in order for the function to activate. The current time and the symbol **auto** will appear on the display. The symbol disappear on the display.

At the end of cooking the heating elements will be deactivated. On the display, the symbol turns off, the symbol **auto** flashes and the buzzer sounds.

6. To turn the buzzer off, simply press one of the programmer clock keys.
7. Press the clock key to reset the programmer clock.

## 12h or 24h format

The default mode is 12h format.

1. Keep the value increase key for a few seconds. The symbols **AM** or **PM** disappear on the display and 24h format is set.
2. Keep the value increase key for a few seconds to return in 12h format.

## Selecting the buzzer

The buzzer can have 3 tones.

1. Hold down the value increase and value decrease keys at the same time.
2. Press the clock key . On the display the digit **ton2** appear.
3. Press the value decrease key to select a different buzzer tone

(**ton1** or **ton3**).



## Cooking information table

Food	Weight (Kg)	Function	Shelf	Temperature (°F)	Time (minutes)	
Lasagne	3 - 4	Convection	1	430 - 450	45 - 50	
Pasta bake	3 - 4	Convection	1	430 - 450	45 - 50	
Roast veal	2	Fan assisted/Fan	2	360 - 380	90 - 100	
Pork	2	Fan assisted/Fan	2	360 - 380	70 - 80	
Sausages	1.5	Fan grill	4	MAX	15	
Roast beef	1	Fan assisted/Fan	2	400	40 - 45	
Roast rabbit	1.5	Fan forced	2	360 - 380	70 - 80	
Turkey breast	3	Fan assisted/Fan	2	360 - 380	110 - 120	
Roast pork neck	2 - 3	Fan assisted/Fan	2	360 - 380	170 - 180	
Roast chicken	1.2	Fan assisted/Fan	2	360 - 380	65 - 70	
					1 <sup>st</sup> surface	2 <sup>nd</sup> surface
Pork chops	1.5	Fan grill	4	MAX	15	5
Spare ribs	1.5	Fan grill	4	MAX	10	10
Bacon	0.7	Grill	5	MAX	7	8
Pork fillet	1.5	Fan grill	4	MAX	10	5
Beef fillet	1	Grill	5	MAX	10	7
Salmon trout	1.2	Fan assisted/Fan	2	300 - 320	35 - 40	
Delicate fish	1.5	Fan assisted/Fan	2	320	60 - 65	
Flounder	1.5	Fan assisted/Fan	2	320	45 - 50	
Pizza	1	Fan assisted/Fan	2	MAX	8 - 9	
Bread	1	Fan forced	2	380 - 400	25 - 30	
Focaccia	1	Fan assisted/Fan	2	360 - 380	20 - 25	
Ring cake	1	Fan forced	2	320	55 - 60	
Jam tart	1	Fan forced	2	320	35 - 40	
Ricotta cake	1	Fan forced	2	320 - 340	55 - 60	
Jam tarts	1	Fan assisted/Fan	2	320	20 - 25	
Paradise cake	1.2	Fan forced	2	320	55 - 60	
Profiteroles	1.2	Fan assisted/Fan	2	360	80 - 90	
Sponge cake	1	Fan forced	2	300 - 320	55 - 60	
Rice pudding	1	Fan assisted/Fan	2	320	55 - 60	
Brioche	0.6	Fan forced	2	320	30 - 35	

The times indicated in the table do not include preheating times and are provided as a guide only.



# Cleaning and Maintenance

## 3 Cleaning and maintenance

### 3.1 Instructions



#### **WARNING** **ELECTRICAL SHOCK HAZARD**

- Before servicing, disconnect the appliance from the power supply.



#### **Improper use** **Risk of damage to surfaces**

- Do not use steam jets to clean the appliance.
- Do not use cleaning products containing chlorine, ammonia or bleach on steel parts or parts with metallic finishes on the surface (e.g. anodizing, nickel- or chromium-plating).
- Do not use abrasive or corrosive detergents on glass parts (e.g. powder products, stain removers and metallic sponges).
- Do not use rough or abrasive materials or sharp metal scrapers.
- Do not wash the removable components such as the hob pan stands, flame spreaders and burner caps in a dishwasher.
- Keeping appliance area clear and free from combustible materials, gasoline and other flammable vapors and liquids.
- Not obstructing the flow of combustion and ventilation air.

### Recommendations



We recommend the use of cleaning products distributed by the manufacturer.

To keep the surfaces in good condition, they should be cleaned regularly after use. Let them cool first.

### Ordinary daily cleaning

Always use only specific products that do not contain abrasives or chlorine-based acids.

Pour the product onto a damp cloth and wipe the surface, rinse thoroughly and dry with a soft cloth or a microfiber cloth.

### Food stains or residues

Do not use metallic sponges or sharp scrapers as they will damage the surfaces.

Use ordinary non-abrasive products with the aid of wooden or plastic utensils if necessary. Rinse thoroughly and dry with a soft cloth or a microfiber cloth.

Do not allow residues of sugary foods (such as jam) to set inside the oven. If left to set for too long, they might damage the enamel lining of the oven.

### Cooktop grates

Remove the grates and clean them with lukewarm water and non-abrasive detergent. Make sure to remove any encrustations. Dry them thoroughly and return them to the cooktop.



## 3.2 Cleaning the hob

1. Pour some non-abrasive detergent on a damp cloth and wipe the surfaces.
2. Rinse thoroughly.
3. Dry with a soft cloth or a microfibre cloth.

### Cleaning cooktop grates, flame-spreader crowns and burner caps

1. Remove the components from the hob.
2. Clean with lukewarm water and non-abrasive detergent. Make sure to remove any encrustations.
3. Dry thoroughly with a soft cloth or a microfibre cloth.
4. Replace the components on the hob.



Continuous contact between the grates and the flame can cause modifications to the enamel over time in those parts exposed to heat. This is a completely natural phenomenon which has no effect on the operation of this component.

## Teppanyaki plate and Griddle

The Teppanyaki plate and the Griddle are easier to clean when it is still lukewarm.

- Use conventional specific detergents for stainless steel and non-abrasive sponges. Any remaining encrustations or food residues can be easily removed by soaking the plate for a while. For very stubborn encrustations, we recommend using the supplied scraper. Dry it carefully.



Do not soak the plate and/or griddle in water immediately after use. Wait for it to cool down.

## Flame spreaders and burner caps

For easier cleaning, the flame spreaders and the burner caps can be removed. Wash them in hot water and non-abrasive detergent. Carefully remove any encrustation, then wait until they are perfectly dry. Refit the flame spreaders making sure that they are correctly positioned in their housings with their respective burner caps.

Visually checking pilot(s) and burner flames.





# Cleaning and Maintenance

## Cleaning the igniters and thermocouples

- If necessary, clean the igniters and thermocouples with a damp cloth.
- If there is any dry residue, remove it with a toothpick or needle.

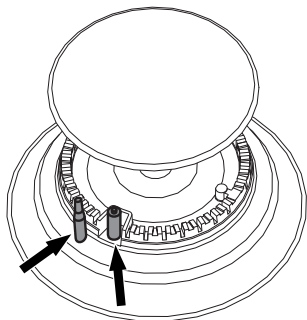

2. Grasp the door on both sides with both hands, lift it forming an angle of around 30° and remove it.

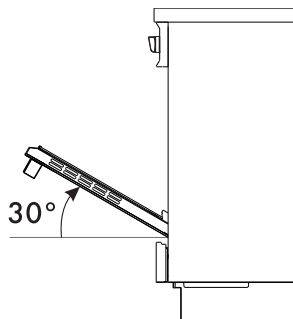

## 3.3 Cleaning the door

### Removing the door

For easier cleaning it is recommended to remove the door and place it on a tea towel.

To remove the door proceed as follows:

1. Open the door completely and insert two pins into the holes on the hinges indicated in the figure.

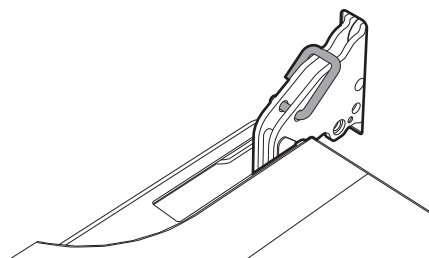

3. To reassemble the door, put the hinges in the relevant slots in the oven, making sure that grooved sections **A** are resting completely in the slots. Lower the door and once it is in place remove the pins from the holes in the hinges.

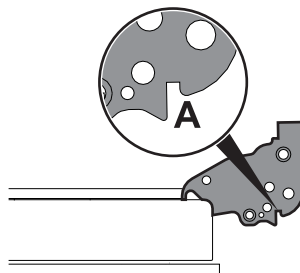

### Cleaning the door glazing

The glass in the door should always be kept thoroughly clean. Use absorbent kitchen roll. In case of stubborn dirt, wash with a damp sponge and an ordinary detergent.





## Removing the internal glass panes

For easier cleaning the internal glass panes of the door can be removed.

1. Pull the rear part of the internal glass pane gently upwards, following the movement indicated by the arrows (1).

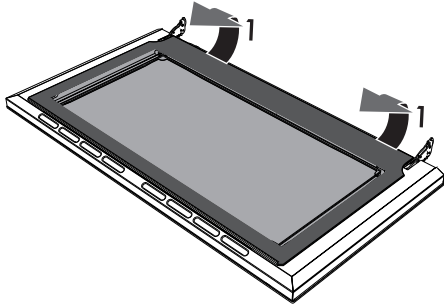

2. Extract the internal glass pane from the front strip (2) to remove it from the door.

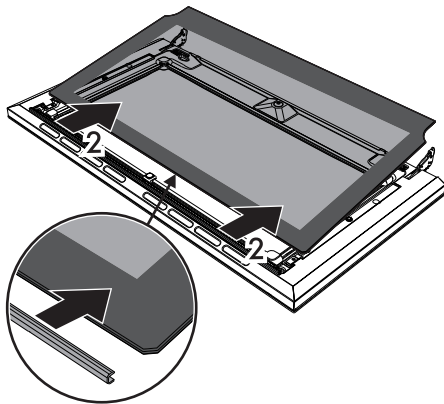

3. Remove the intermediate glass pane by lifting it upwards.

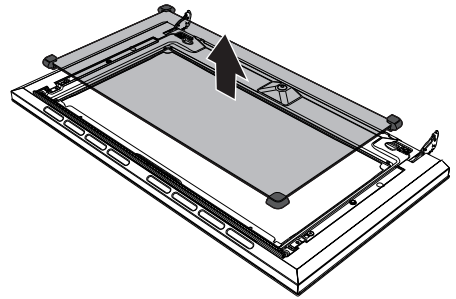

4. Clean the external glass pane and the panes removed previously. Use absorbent kitchen roll. In case of stubborn dirt, wash with a damp sponge and neutral detergent.

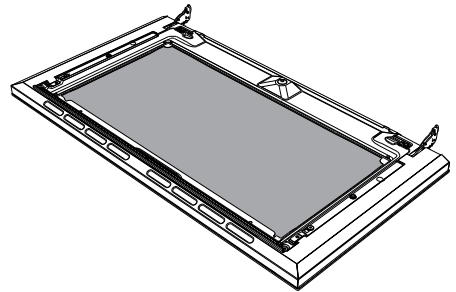

5. When you have finished cleaning, reinsert the intermediate glass pane in its housing in the door.
6. To reposition the internal glass pane, slide the upper part into the door strip and insert the two rear pins into their seats by pressing lightly.



## Cleaning and Maintenance

### 3.4 Cleaning the oven cavity

In order to keep your oven in the best possible condition, clean it regularly after letting it cool down.

Avoid letting food residue dry inside the oven cavity, as this could damage the enamel.

Take out all removable parts before cleaning.

For easier cleaning, we recommend removing:

- The door
- The rack/tray support frames
- Removable guides, where fitted
- The seal



In the event you are using specific cleaning products, we recommend running the oven at maximum temperature for 15-20 minutes in order to eliminate any residue.

### Removing racks/trays support frames

Removing the rack/tray support frames enables the sides to be cleaned more easily.

To remove the rack/tray support frames:

- Pull the frame towards the inside of the oven to unhook it from its groove **A**, then slide it out of the seats **B** at the back.

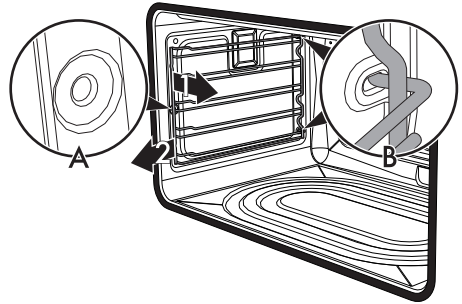

- When cleaning is complete, repeat the above procedures to put the rack/tray support frames back in.



## Cleaning the top section

The oven cavity is fitted with a tilting heating element which facilitates cleaning the top part (roof) of the oven.

1. Free the upper heating element by gently lifting it and rotating its retainers by 90 degrees.

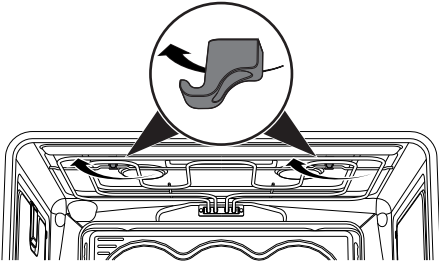

2. Gently lower the heating element until it stops.

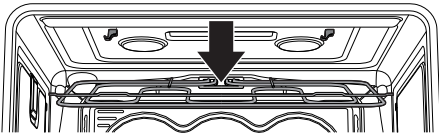

**Improper use**  
**Risk of damage to the appliance**

- Do not excessively flex the element during cleaning.

3. When you have finished cleaning, place the heating element back in position and turn the retainers to lock it in place again.

## Vapor Clean



Vapor Clean is an assisted cleaning procedure which facilitates the removal of dirt. Thanks to this process, it is possible to clean the inside of the oven very easily. The dirt residues are softened by the heat and water vapour for easier removal afterwards.



**Improper use**  
**Risk of damage to surfaces**

- Remove any food residues or large spills from previous cooking operations from the inside of the oven.
- Carry out assisted oven cleaning operations only when the oven is cold.

## Preliminary operations

Before starting the Vapor Clean function:

- Completely remove all accessories from inside the oven.
- Remove the rack/tray support frames.
- Detach removable guides, where fitted.
- Close the door.



## Cleaning and Maintenance

- Pour approximately 40 cc of water into the tray. Make sure it does not overflow out of the cavity.

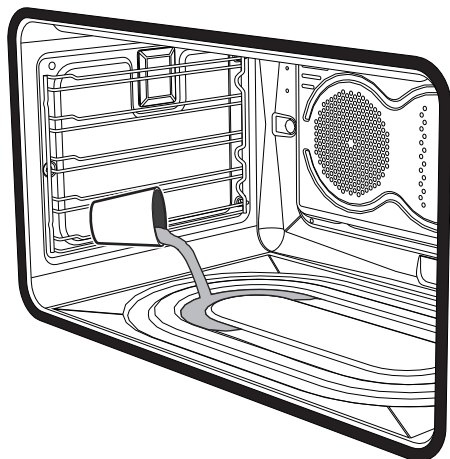

- Spray a water and washing up liquid solution inside the oven using a spray nozzle. Direct the spray against the side walls, upwards, downwards and towards the deflector.

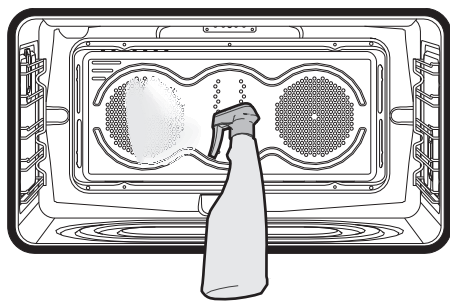

- Close the door.



We recommend spraying approx. 20 times at the most.

### Vapor Clean cycle setting

1. Turn the function knob to the symbol  and the temperature knob at a temperature ranging between **120°F** and **180°F**.
2. Set a cooking time of **18 minutes** using the programmer clock.

The Vapor Clean cycle starts a few seconds after the last press on the programmer clock keys.

3. At the end of the Vapor Clean cycle, the timer will deactivate the oven heating elements, the buzzer will start to sound and the numbers on the programmer clock dial will flash.



## End of the Vapor Clean cycle

4. Open the door and wipe away the less stubborn dirt with a microfibre cloth.
5. Use a non-scratch sponge with brass filaments on hard to remove deposits.
6. In case of grease residues use specific oven cleaning products.
7. Remove the residual water inside the oven.

For improved hygiene and to avoid food being affected by any unpleasant odours, we recommend that the oven is dried using a fan-assisted function at 360°F for approximately 10 minutes.



We recommend wearing rubber gloves for these operations.



We recommend removing the door in order to make the manual cleaning of the parts that are difficult to reach easier.

## 3.5 Extraordinary maintenance

### Replacing the internal light bulb



Live parts  
**Danger of electrocution**

- Unplug the appliance.



The oven is fitted with two 40W light bulbs.

1. Completely remove all accessories from inside the oven.
2. Remove the rack/tray support frames.
3. Remove the bulb cover using a tool (e.g. a screwdriver).



Pay attention not to scratch the oven cavity enamel.

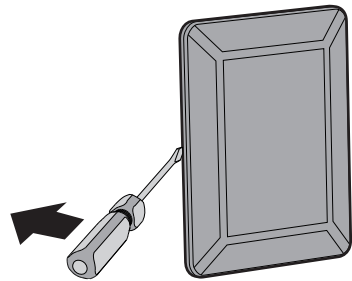



## Cleaning and Maintenance

4. Slide out and remove the light bulb.

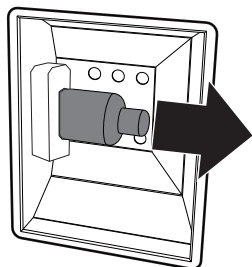

Do not touch the halogen light bulb directly with your fingers, but wrap it in insulating material.

5. Fit the new light bulb.  
6. Refit the cover. Ensure the moulded part of the glass (**A**) is facing the door.

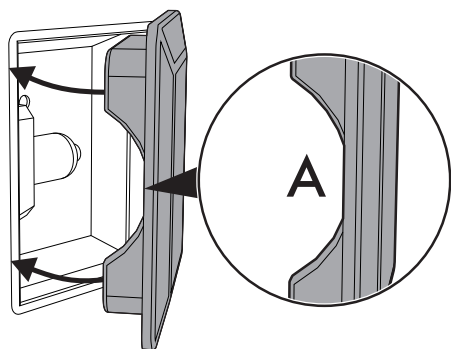

7. Press the cover completely down so that it attaches perfectly to the bulb support.

### What to do if...

#### The appliance is not working properly:

- The switch is defective: check the fuse box to see whether the switch is in working order.
- Loss of power: check that the appliance indicator lights are operational.

#### The gas burner does not light:

- Loss of power or moisture in the igniters: light the gas burner with a lighter or match.

#### The oven does not heat up:

- Defective fuse: check and replace the switch if necessary.
- The function knob has not been set: set the function knob.

#### All food prepared in the oven burns within a short time:

- Defective thermostat: contact an Authorised Service Centre

#### The door glass mists up when the oven is hot:

- Completely normal behaviour caused by the difference in temperature which has no effect on the oven's performance.



If the door is opened during a fan assisted function, the fan stops:

- This is not a fault. It is a normal operation of the appliance, useful when cooking foods in order to avoid excessive heat escaping. When the door is closed, the oven will return to normal operation.



If the problem has not been resolved or in the case of other types of fault, contact your local technical support centre.



If other ERRx error messages are indicated:  
Note down the error message, function and set temperature and contact your local technical support centre.

## Minimum adjustment

### For natural Gas:

Light the burner and turn the knob to the minimum position . Remove the gas tap knob and turn the adjustment screw at the side of the tap rod until the desired minimum flame is achieved.

Refit the knob and verify that the burner flame is stable (when turning the knob rapidly from the maximum to the minimum position the flame must not go out).

Repeat this operation on the remaining gas taps on the cooktop.

### For LP Gas:

Turn off the burners and unplug the appliance from the electrical power supply. For regulating the minimum with LP, the screws at the side of the tap rod must be turned clockwise all the way. Once the regulation has been completed, replace the seal on the by-passes using paint or similar materials. Follow the instructions given in point 9 to locate the adjustment screws.

### Lubricating the surface burner gas valves

Over time, the surface burner gas valves may become stiff or jam. Clean them internally and relubricate. This operation must be carried out by a qualified technician.

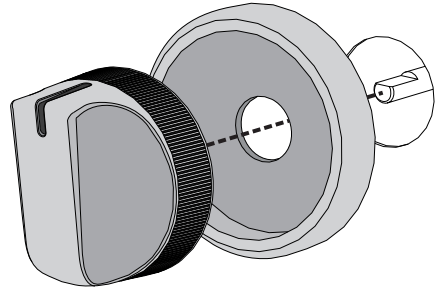

PAGE INTENTIONALLY LEFT BLANK