

# Owner's Manual

36" Rangetops

49-85218

05-14 GE



*Contents*

**Surface Cooking**  
Burners ..... 9  
Controls ..... 9, 10  
Cookware ..... 10  
Dual-Flame Stacked Burners ..... 9  
Features ..... 8  
Griddle ..... 13  
Grill ..... 11, 12

**Care and Cleaning**  
Burner Caps ..... 14  
Burner Grates ..... 15  
Control Panel and Knobs ..... 16  
Cutting Board ..... 16  
Grease Troughs ..... 15  
Griddle ..... 16  
Grill ..... 17  
Stainless Steel ..... 14

**Consumer Services**  
Important Phone Numbers ..... 19  
Model and Serial Number ..... 3  
Problem Solver ..... 18  
Safety Instructions ..... 4-7  
Warranty ..... 20

**⚠ WARNING:** If the information in this manual is not followed exactly, a fire or explosion may result, causing property damage, personal injury or death.

- Do not store or use gasoline or other flammable vapors and liquids in the vicinity of this or any other appliance.
- **WHAT TO DO IF YOU SMELL GAS**
  - Do not try to light any appliance.
  - Do not touch any electrical switch; do not use any phone in your building.
  - Immediately call your gas supplier from a neighbor's phone. Follow the gas supplier's instructions.
  - If you cannot reach your gas supplier, call the fire department.
- Installation and service must be performed by a qualified installer, service agency or the gas supplier.

---

*Remove packaging tape*

Carefully remove all packaging, foam pads and tape.

To assure no damage is done to the finish of the product, the safest way to remove the adhesive from packaging tape on new appliances is an application of a household liquid dishwashing detergent. Apply with a soft cloth and allow to soak.

**NOTE:** *The adhesive must be removed from all parts. It cannot be removed if it is heated.*

---

*Write down the model & serial numbers*

You'll find them on a label located behind the left burner knob or on the bottom of the rangetop.

**Before sending in the registration card, please write these numbers here:**

\_\_\_\_\_  
Model Number

\_\_\_\_\_  
Serial Number

Use these numbers in any correspondence or service calls concerning your rangetop.

---

*If you received a damaged rangetop*

Immediately contact the dealer (or builder) that sold you the rangetop.

---

*Troubleshooting tips*

Before you request service, check the Problem Solver in the back of this manual.

It lists causes of minor operating problems that you can correct yourself.

---

*If you need service*

To obtain service, see the Consumer Services page in the back of this manual.

We're proud of our service and want you to be pleased. If for some reason you are not happy with the service you receive, here are the steps to follow for further help.

FIRST, contact the people who serviced your appliance. Explain why you are not pleased. In most cases, this will solve the problem.

NEXT, if you are still not pleased, write all the details—including your phone number—to:

Manager, Customer Relations  
GE Appliances  
Appliance Park  
Louisville, KY 40225

# IMPORTANT SAFETY INSTRUCTIONS

---

## *IMPORTANT SAFETY NOTICE*

- The California Safe Drinking Water and Toxic Enforcement Act requires the Governor of California to publish a list of substances known to the state to cause cancer, birth defects or other reproductive harm, and requires businesses to warn customers of potential exposure to such substances.
- Gas appliances can cause minor exposure to four of these substances, namely benzene, carbon monoxide, formaldehyde and soot, caused primarily by the incomplete combustion of natural gas or LP fuels.  
  
Properly adjusted burners, indicated by a bluish rather than a yellow flame, will minimize incomplete combustion. Exposure to these substances can be minimized by venting with an open window or using a ventilation fan or hood.

---

## **⚠ WARNING:** *SAFETY PRECAUTIONS*

When using your appliance, follow basic safety precautions, including the following:

- **Have the installer show you the location of the rangetop gas shut-off valve and how to turn it off if necessary.**
- **Be sure all packing materials are removed from the rangetop** before operating it to prevent fire or smoke damage should the packing material ignite.
- **Locate the rangetop out of kitchen traffic path and out of drafty locations and areas with poor air circulation.**
- **Do not install this product with an air curtain hood** or other range hood that operates by blowing air down on the cooktop. This airflow may interfere with operation of the gas burners resulting in fire or explosion hazard.

# IMPORTANT SAFETY INSTRUCTIONS

---

## **⚠** WARNING: *SAFETY PRECAUTIONS*

- **Use this appliance only for its intended use** as described in this manual.
- **Be sure your appliance is properly installed and grounded** by a qualified technician in accordance with the provided installation instructions.
- **Do not attempt to repair or replace any part of your rangetop unless it is specifically recommended in this manual.** All other servicing should be referred to a qualified technician.
- **Before performing any service, DISCONNECT THE RANGETOP POWER SUPPLY AT THE HOUSEHOLD DISTRIBUTION PANEL BY REMOVING THE FUSE OR SWITCHING OFF THE CIRCUIT BREAKER.**
- **Do not leave children alone**—children should not be left alone or unattended in an area where an appliance is in use. They should never be allowed to sit or stand on any part of the appliance.
- **Do not store flammable materials near the rangetop.**
- **Do not store plastic, flammable liquids or combustible materials on top of the optional high shelf.**
- **CAUTION: ITEMS OF INTEREST TO CHILDREN SHOULD NOT BE STORED IN CABINETS ABOVE A RANGETOP OR ON THE BACKSPASH OF A RANGETOP—CHILDREN CLIMBING ON THE RANGETOP TO REACH ITEMS COULD BE SERIOUSLY INJURED.**
- **Never use this appliance as a space heater to heat or warm the room.** Doing so may result in carbon monoxide poisoning or overheating of the appliance.
- **Never wear loose-fitting or hanging garments while using the appliance.** Be careful when reaching for items stored over the rangetop. Flammable material could be ignited if brought in contact with surface burners or burner grates and may cause severe burns.
- **Use only dry pot holders**—moist or damp pot holders on hot surfaces may result in burns from steam. Do not let pot holders touch surface burners, burner grates or oven heating elements. Do not use a towel or other bulky cloth.
- **When surface cooking, do not touch surface burners, burner grates, grill or griddle (on some models) or the surrounding areas.**

These surfaces may be hot enough to burn.

During and after use, do not touch, or let clothing or other flammable materials contact, the surface burners, grill or griddle (on some models), and areas near the surface burners; allow sufficient time for cooling first.

Potentially hot surfaces include the rangetop, areas facing the rangetop, or any backguard or high shelf surface.
- **Keep the ventilator hood and grease filters clean to maintain good venting and to avoid grease fires.** Turn the ventilator OFF in case of fire or when intentionally “flaming” liquor or other spirits on the rangetop. The blower, if in operation, could spread the flames.

# IMPORTANT SAFETY INSTRUCTIONS

---

## **⚠ WARNING: SAFETY PRECAUTIONS**

- **Do not use water on grease fires. Never pick up a flaming pan.** Turn the controls off. Smother a flaming pan on a surface unit by covering the pan completely with a well-fitting lid, cookie sheet or flat tray. Use a multi-purpose dry chemical or foam-type fire extinguisher.  
Flaming grease outside a pan can be put out by covering it with baking soda or, if available, by using a multi-purpose dry chemical or foam-type fire extinguisher.
- **DO NOT STORE OR USE COMBUSTIBLE MATERIALS, GASOLINE OR OTHER FLAMMABLE VAPORS AND LIQUIDS IN THE VICINITY OF THIS OR ANY OTHER APPLIANCE.**
- **Do not let cooking grease or other flammable materials accumulate in or near the rangetop. Clean grease troughs (some models) and burner pans after every use.**
- **If you smell gas,** the installer has not done a proper job of checking for leaks. You can have a small leak, and therefore a faint gas smell, if the connections are not completely tight.  
Finding a gas leak is **NOT** a do-it-yourself procedure. Some leaks can only be found with the burner control in the ON position. For your protection, it must be done by a qualified service technician. Never use an open flame to locate a leak.
- **If by some chance a burner goes out and gas escapes, open a window or a door to let the room air out.** Do not attempt to use the appliance until the gas has had time to dissipate. Follow the instructions in "What to do if You Smell Gas" on page 2.
- **Be sure all the controls are turned off and the appliance is cool** before using any type of aerosol cleaner or cooking spray on or around the appliance. The chemical that produces the spraying action could, in the presence of heat, ignite or cause metal parts to corrode.
- **Do not heat unopened food containers;** a buildup of pressure may cause the container to burst.
- **Set the burner control so that the flame heats only the bottom of the pan** and does not extend beyond the bottom of the pan. Excessive flame is hazardous. The high BTU burners can easily melt cookware handles.
- **Hold the handle of the pan, using a dry pot holder,** to prevent movement of the utensil when stirring or turning food.
- **Always use the LITE position when igniting the surface burners** and make sure the burners have ignited.

# IMPORTANT SAFETY INSTRUCTIONS

---

## **⚠ WARNING:** *SURFACE COOKING SAFETY PRECAUTIONS*

- **Never leave the surface burners unattended at high flame settings.** Boilovers cause smoking and greasy spillovers that may catch on fire. If the burner flames are smothered by a severe boilover which affects the igniter, unburned gas will escape into the room.
- **To minimize the possibility of burns,** ignition of flammable materials and spillage, turn cookware handles toward the side or back of the rangetop without extending over adjacent burners.
- **Always turn the surface burners to OFF before removing cookware.**
- **Carefully watch foods being fried at a high flame setting.**
- **Foods for frying should be as dry as possible.** Frost on frozen foods or moisture on fresh foods can cause hot fat to bubble up and over the sides of the pan.
- **Use the least possible amount of fat for effective shallow or deep fat frying.** Filling the pan too full of fat can cause spillovers when food is added.
- **Use a deep fat thermometer** whenever possible to prevent overheating fat beyond the smoking point.
- **Always heat fat slowly, and watch as it heats.**
- **Never try to move a pan of hot fat,** especially a deep fat fryer. Wait until the fat is cool.
- **If a combination of oils or fats will be used in frying,** stir together before heating or as fats melt slowly.
- **When using glass cookware,** make sure it is designed for top-of-rangetop cooking.
- **Do not leave any items on the rangetop.** The hot air from the vent may ignite flammable items and will increase pressure in closed containers, which may cause them to burst.
- **Do not use aluminum foil to cover the grates or line any part of the rangetop.** Doing so may result in carbon monoxide poisoning, overheating of the rangetop surfaces, or a potential fire hazard.
- **Use proper pan size**—avoid pans that are unstable or easily tipped. Select cookware having flat bottoms large enough to properly contain food and avoid boilovers and spillovers and large enough to cover burner grate. This will save cleaning time and prevent hazardous accumulations of food, since heavy spattering or spillovers left on the rangetop can ignite. Use pans with handles that can be easily grasped and remain cool.
- **Do not leave plastic items on the rangetop**—they may melt if left too close to the vent or burner.
- **To avoid the possibility of a burn,** always be certain that the controls for all burners are at the OFF position and all grates are cool before attempting to remove them.
- **Grease is flammable.** Let hot grease cool before attempting to handle it. Avoid letting grease deposits collect in the grill or the griddle grease troughs (some models). Clean these areas after each use.
- **For proper lighting and performance of the rangetop burners, keep the burner ports clean.** It may be necessary to clean these when there is a boilover or when the burner does not light, even though the electronic igniters click.
- **After cleaning, it is important to make sure the cap and burner port are properly aligned with the burner base.** Incorrect alignment will produce poor burner performance. Never operate the burner without all burner parts in place.
- **Clean the rangetop with caution.** Avoid steam burns; do not use a wet sponge or cloth to clean the rangetop while it is hot. Some cleaners produce noxious fumes if applied to a hot surface. Follow manufacturer's directions.
- **Do not use the grill for cooking excessively fatty meats or products that can flare-up.**
- **If the rangetop is located near a window,** do not hang long curtains that could blow over the surface burners and create a fire hazard.

SAVE THESE INSTRUCTIONS

# Features of Your Rangetop

*Professional Rangetops*

## Design information

(Not all features are on all models. Appearance may vary.)

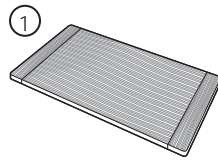

Bamboo Cutting Board

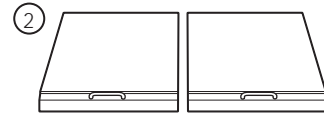

Grill and Griddle Covers

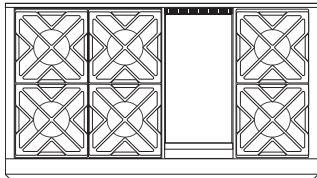

ZGU486NR, ZGU486LR-6 burners and grill  
ZGU486ND, ZGU486LD-6 burners and griddle

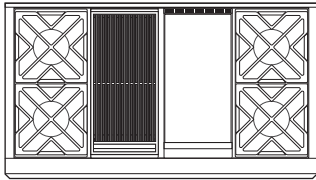

ZGU484NG, ZGU484LG  
4 burners, grill and griddle

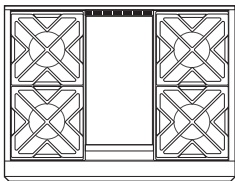

ZGU364NR, ZGU364LR-4 burners and grill  
ZGU364ND, ZGU364LD-4 burners and griddle

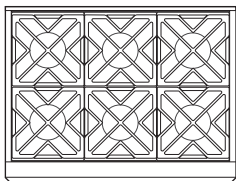

ZGU366N, ZGU366L, CGU366S  
6 gas burners

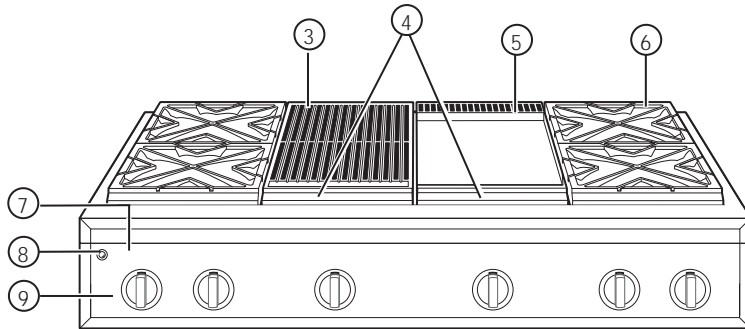

Feature Index		Page
1	Bamboo Cutting Board	16
2	Grill and Griddle Covers	--
3	IR (Infrared) Grill	11, 12
4	Grill and Griddle Grease Troughs	15
5	Griddle	16
6	Rangetop Burner Grates	15
7	Burner Location Indicator	--
8	LED Bullnose Task Lighting Control	--
9	Burner Control Knob with Lighted Bezel	--



## *Electronic ignition & automatic reignition*

The rangetop is equipped with electronic ignition which eliminates the need for a standing pilot light.

The burners will automatically relight if the flame goes out.

All surface burner igniters will spark and make clicking sounds when any burner is turned on. Do not touch any of the burners when igniters are clicking.

Occasionally the burners may spark if excess wind or a draft blows the flame away from the burner's flame sensor.

The griddle and IR (infrared) grill are equipped with Glo-Bar igniters. The Glo-Bar remains energized whenever the griddle or IR grill is in use to ensure the burner always stays lit.

**In case of a power outage**, you can light the surface burners on your rangetop with a match. Hold a lighted match to the burner, then turn the knob to the LOW position. **Use extreme caution when lighting burners this way.**

Do not attempt to light the grill or griddle during a power outage. The gas to these burners will automatically shut off during a power outage.

## *To light a surface burner*

Push the control knob in and turn it **counterclockwise** to the **LITE** position.

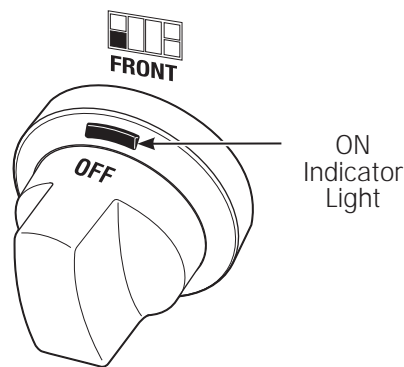

**After the burner ignites**, turn the knob to adjust the flame size.

**To turn a burner off**, turn the knob clockwise, as far as it will go, to the **OFF** position.

- Do not operate a burner for an extended period of time without cookware on the grate. The finish on the grate may chip without cookware to absorb the heat.
- The indicator light on each bezel verifies the burner is on. However, it should not be a substitute for visually checking the flame at the burner.

## *Dual-flame stacked burners*

All surface burners have two sets of flames stacked one on top of the other; the dual-flame burners have a lower (simmer) flame and an upper (main) flame.

When a burner is turned on, the lower flame will always light and stay on.

### **Simmering:**

The stacked burner design provides a wide rangetop of heat settings with which to simmer. Depending on the type and quantity of food, and pan size, the flame can be adjusted to suit your specific need. The lowest setting uses only the lower flame and can maintain delicate foods at a safe 140°F.

### **Cooking:**

Settings from **LO** to **X-HI** will use both upper and lower flames. Use **LO** to **HI** for all purpose cooking. Use **HI** or **X-HI** (highest setting) with larger diameter cookware.

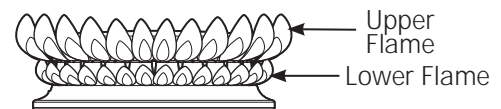
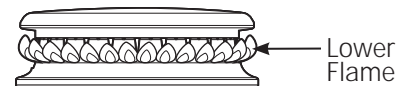

**X-HI** and **HI** are very high heat settings and are intended to sear foods quickly and boil large quantities of water.

## Surface Cooking

### Professional Rangetops

#### How to select flame size

Watch the flame, not the knob, as you increase or reduce heat.

The flame size on a gas burner should match the cookware you are using.

**FOR SAFE HANDLING OF COOKWARE, NEVER LET THE FLAME EXTEND UP THE SIDES OF THE COOKWARE.** Any flame larger than the bottom of the cookware will not result in faster heating and could be hazardous.



For surface stability, 6" minimum diameter cookware is recommended. Use larger diameter cookware for heat settings between **HI** and **X-HI**.

#### Wok cooking

The burner grates are uniquely designed to cook on either side. The flat side accommodates flat bottom cookware (stockpots, sauce pans, frying pans and flat bottom woks), while the wok side is designed to hold a wide variety of round bottom woks without the need for a separate ring.

**For easy access, a front burner location is recommended for wok cooking.**

The front center burner is recommended for wok cooking on 6-burner 36" and 48" rangetops.

**⚠ CAUTION:** To properly fit the grate and match the flame size, the wok must be between 12" and 14" in diameter.

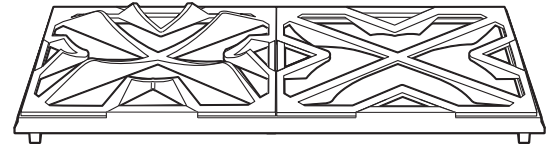

Wok Side

Flat Side

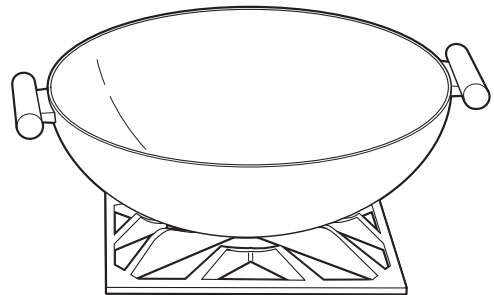

### Grill safety precautions (on some models)

**▲ WARNING:** Do not leave the IR grill unattended at any time.

#### Grease Flare-ups:

Occasionally, during grilling, grease drippings can ignite creating minor bursts of flame for a second or two. This is normal when grilling.

The grill radiant baffle is designed to catch excess grease, limiting flare-ups.

If a flare-up becomes excessive, remove the food from the grill and lower the heat setting until the flare-up subsides.

To further reduce flare-ups, trim excess fat around the edges of steaks and chops, use hamburger that is lean, remove the skin from poultry, etc.

Use a long spatula and a non-flammable mitt when turning food on the grill.

#### Grill Cover:

Remove the cover before lighting the burner. For your safety, the cover must be removed when using the grill. If the cover is left in place it will become extremely hot.

#### Cookware:

Do not use any cookware on the grill.

### Using the IR grill

**Remove the cover** before lighting the burner. The cover must be removed when using the IR grill.

Set the control knob to **PREHEAT**. The longer the grill is preheated, the darker the grill marks will be on the food.

Allow 5 to 15 minutes to fully preheat the grill.

After preheat, the control knob may be set to any position between **HI** and **LO**.

#### Do not leave the grill unattended at any time.

The intense heat caramelizes fats and juices creating authentic barbecued flavor. The IR grill will achieve the same results as an outdoor grill.

All gas grills cook differently. Adjust cooking times and methods when using the IR grill.

Clean the grill grate, grease trough and grease basin after each use. Remove the parts for cleaning after they are cool to the touch.

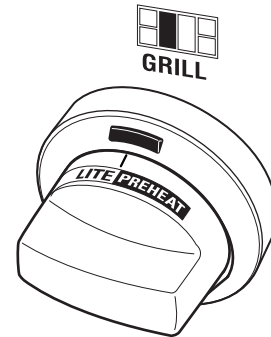

**NOTE:** The grill will take approximately 45 seconds to ignite. Unlike the surface burners, which use electric igniters, the grill uses a Glo-Bar for ignition. It takes approximately 45 seconds for the Glo-Bar to reach temperature. Gas is only supplied to the grill once the Glo-Bar reaches temperature.

## Grill grates

*(on some models)*

Remove the cover before lighting the IR grill.

The grill grate is reversible. Place the handle end toward the front of the Rangetop.

The grate will change color when subjected to the heat, and as oils cook onto the surface. This is normal and does not affect the cooking performance.

The porcelainized cast-iron grill grate does not need to be seasoned.

One side of the grate (Side A) is grooved and should be used for foods such as steak or hamburger patties. The grooves are sloped so the excess liquids and oils run toward the front of the grill and into the grease trough.

The other side of the grate (Side B) is designed for delicate foods such as fish.

Turn and move foods as needed.

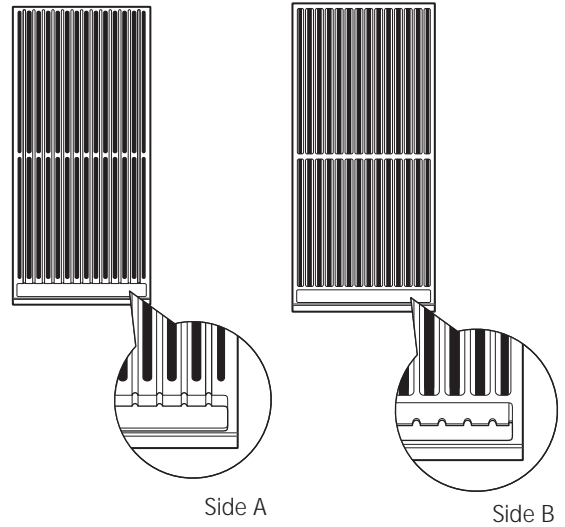

Food	Setting	Preheat
Hamburger Patties (8)	HI or LO	5 Minutes
Chicken Breast (6) (Bone side down)	LO	5 Minutes
T-Bone Steak (1-1/2" thick)	LO	5 Minutes
Salmon	LO	5 Minutes

## Grill radiant baffle

Models equipped with an IR grill have a radiant baffle which distributes the heat from the burners evenly across the grill area. The grill baffle also helps to limit grease flare-ups.

The grill baffle rests on tabs in the grill opening. Be sure the baffle is secured in place by fully engaging the tabs.

**IMPORTANT:** Avoid contact with the igniter. It is fragile and can chip or break.

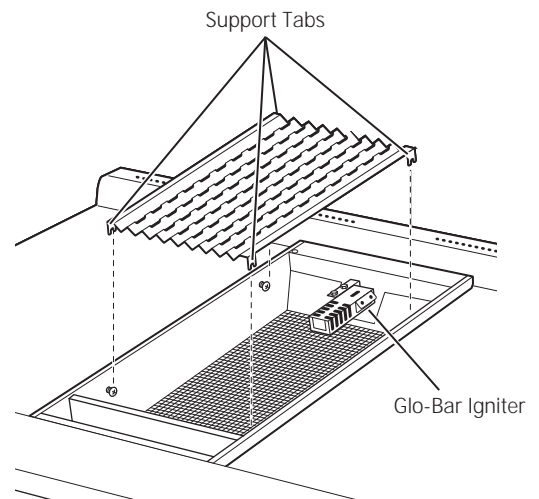

### Griddle safety precautions, leveling

(on some models)

**⚠ WARNING:** Do not allow the airflow from the griddle flue cover to be obstructed by cookware or towels.

Remove the metal cover and the cutting board before turning the griddle on.

**The griddle assembly should not be removed for cleaning.**

Once the unit is in position, the griddle can be leveled. Remove the flue cover by lifting it straight up. Be careful not to scratch the surrounding stainless steel surfaces during removal of the flue cover.

The two inner screws are clamping screws for securing the griddle in place. Loosen these two screws before leveling. **Do not remove these two screws.**

The two outer screws are leveling screws. **Do not remove these two screws.** They can be turned to level the griddle or to provide a forward slope to help grease and oils to drain away from the food being cooked. After the first few uses, you will be able to judge the slope best suited for the foods you are cooking and personal preference.

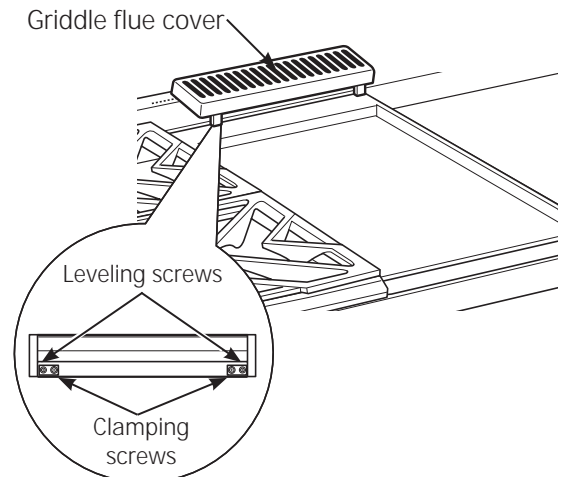

After leveling the griddle, tighten the clamping screws to secure griddle in place. **Hand tighten screws; do not over-tighten.**

### Season the griddle

**Before using the griddle for the first time, it must be seasoned.**

If the griddle has not been used for a period of time, it should be reseasoned.

1. Clean the griddle thoroughly with hot, soapy water to remove any protective coating.
2. Wipe the surface using a solution of 1 quart water and 1 cup white vinegar. Dry thoroughly.
3. Use a paper towel and wipe 1 tablespoon vegetable oil evenly across the griddle. Do not use corn oil as it can get sticky.

4. Turn the control knob to 400°F for approximately 30 minutes. Turn the heat off when the oil starts to shimmer.
5. Repeat Step 3. Be sure to cover the entire surface with the oil.
6. Allow the griddle to cool. Wipe the entire surface of the griddle using a heavy cloth to remove the oil. The griddle is now ready to use.

### Using the griddle

The griddle surface is a combination of highly polished Type 304 stainless steel and an aluminum thermal plate for even heat distribution. It is normal for it to darken with use as oils cook onto the surface to provide a stick-resistant base or "seasoning."

The griddle is thermostatically controlled and can be set to maintain any temperature from 200°F to 450°F.

**NOTE:** Unlike the surface burners, which use electric igniters, the griddle uses a Glo-Bar for ignition. It takes approximately 45 seconds for the Glo-Bar to reach temperature. Gas is only supplied to the griddle once the Glo-Bar reaches temperature.

To heat the griddle, push in the control knob and turn to the desired temperature setting. The light on the bezel will glow to indicate the thermostat control is working.

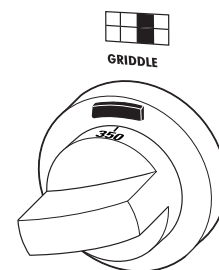

Food Item	Temperature Setting
Pancakes	375°F
Hamburgers	400°F
Bacon*	400°F
Grilled Cheese	350°F
Eggs	275°F

**\*NOTE:** Place bacon on a cold griddle. Do not preheat.

*Dual-flame stacked burners*

The burner consists of three parts: the burner base, burner head and burner cap. The burner head and burner cap can be lifted off, making them easy to clean.

**⚠ CAUTION:** DO NOT OPERATE THE BURNER WITHOUT ALL BURNER PARTS IN PLACE.

Surface burners should be cleaned routinely, especially after bad spillovers, which could clog the slots and holes in the burner heads.

The electrode is located at the rear of each burner. Do not attempt to disassemble or clean around any burner while another burner is on. An electric shock may result.

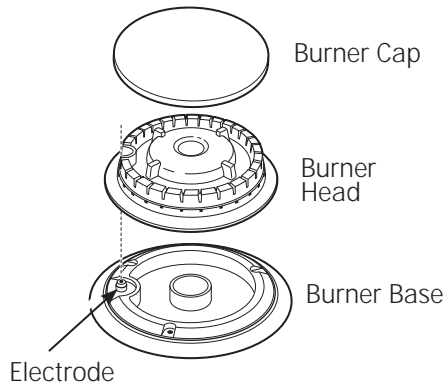

**To remove the burner parts:**

1. Turn all controls **OFF** before removing any burner parts.
2. When cool, you may lift off the burner grates, burner caps and burner heads for easier cleaning. **Do not remove the burner bases.**

**Cleaning**

Lift off burner parts only when cool. Wash in hot, soapy water. You may use a plastic scouring pad to remove burned-on food particles.

**To remove burned-on food,** soak the burner heads in a solution of mild liquid detergent and hot water for 20–30 minutes. For more stubborn stains, use a plastic scouring pad or toothbrush.

If the spill goes inside the burner head assembly, wash it under running water and shake to remove excess water.

**After Cleaning**

**Before replacing the burner parts, shake out excess water and then dry them thoroughly.**

**To replace the burner parts:**

Make sure that the burner parts are replaced in the correct location.

1. Replace the burner head on top of the burner base, making sure that the hole in the burner head is properly aligned with the electrode in the burner base. A small gap between the base and head is normal.
2. Place the burner cap on top of the burner head. Make sure that the burner cap is properly seated on the burner head.

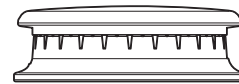

Burner cap properly seated

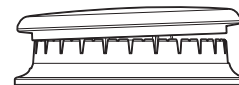

Burner cap not properly seated

*Stainless steel surfaces*

Do not use a steel-wool pad; it will permanently scratch the surface.

To clean the stainless steel surface, use warm sudsy water or a stainless steel cleaner. Always wipe the surface in the direction of the grain. Follow the cleaner instructions for cleaning the stainless steel surface.

A bottle of stainless steel cleaner is provided with the rangetop.

To inquire about purchasing stainless steel appliance cleaner, please call our toll-free number, 800.626.2002 or visit [GEAppliances.com](http://GEAppliances.com).

### Spark igniter and electrodes

The electrode of the electronic ignition system is positioned at the rear of the burner base. When cleaning the rangetop, be careful not to snag the igniter with your cleaning cloth. Damage to the igniter could occur.

Be careful not to push in a control knob while cleaning. It could cause the igniter to spark.

Make sure that the white ceramic igniters on the rangetop are dry and clean. Clean the metal portion of the electrode with a soft cloth or emery board.

**Do not attempt to remove the electrode from the rangetop.**

Clean this metal part with an emery board.



Do not clean this white ceramic part with an emery board.

### Burner grates

The enameled cast-iron burner grates should be cleaned regularly.

The grates can be cleaned in the dishwasher. The frames may be cleaned by hand or in the dishwasher.

Wash them in hot soapy water, rinse, and dry thoroughly.

Although they are durable, the grates will gradually lose their shine, regardless of the best care you can give them. This is due to their continual exposure to high temperatures.

Do not operate a burner for an extended period of time without cookware on the grate. The finish on the grate may chip without cookware to absorb the heat.

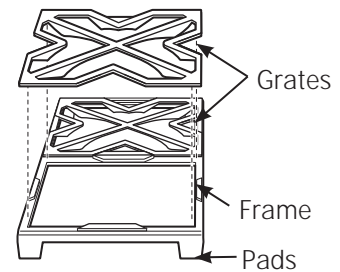

For stability, the frames have rubber pads on each corner. During cleaning and use, be careful not to damage or snag rubber pads.

### Grease troughs

(on some models)

Grease from the griddle and the grill will drain into the enameled cast-iron grease troughs at the front of the rangetop. Once the troughs have cooled, they may be lifted out for easier cleaning.

**To remove the cool grease trough from the griddle,** slide it toward the front and lift up.

**To remove the cool grease trough from the grill,** lift the grill frame and lift out the trough.

Do not allow grease to accumulate in the grease troughs as it can be a fire hazard. Clean the grease troughs as soon as they are cool. The grease troughs can be cleaned by hand with hot soapy water or in the dishwasher. Wipe any spillage in the trough basin with a soft cloth.

For stability, the troughs have rubber pads at the front. Be careful not to damage the pads when removing for cleaning.

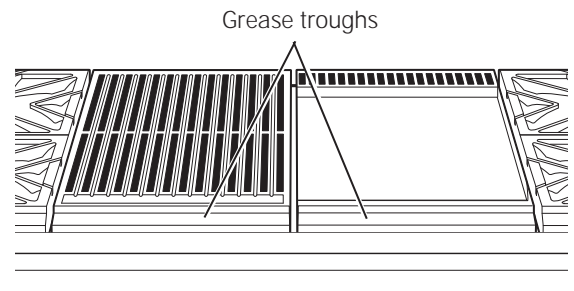



### Griddle

(on some models)

Thoroughly clean the griddle of grease and food particles, using a square-edged metal spatula, while it is still hot.

Wipe the griddle with a dry, heavy, coarse cloth to remove any remaining residue and food particles. If the griddle is cleaned with anything other than a dry, heavy, coarse cloth, it will need to be reseasoned.

Never flood the hot griddle with cold water. This could cause the griddle to crack or warp.

### Cutting board

(on some models)

Wash the bamboo cutting board with warm water and a mild soap. Occasionally, wipe it with mineral oil.

**Do not clean the cutting board in the dishwasher.**

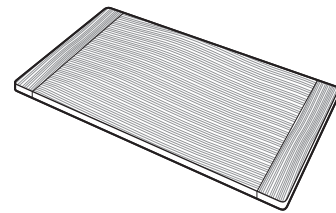

### Control panel and knobs

Clean up spatters with a damp cloth.

Remove heavier soil with warm, soapy water.

Do not use abrasives of any kind on the control panel or knobs.

The control knobs may be removed for easier cleaning. To remove a knob, pull it straight off the control panel. Wash the knobs in hot soapy water, but do not soak.

An optional set of black control knobs is available for purchase at additional cost. Order the knob set for your model.

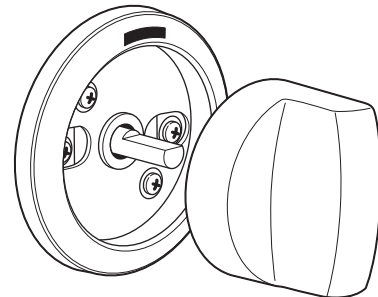

Models	Order Numbers
ZGU366NPSS, ZGU366LPSS	WB03K10269
ZGU364NRPSS, ZGU364LRPSS	WB03K10270
ZGU364NDPSS, ZGU364LDPSS	WB03K10271
ZGU484NGPSS, ZGU484LGPSS	WB03K10272
ZGU486NRPSS, ZGU486LRPSS	WB03K10273
ZGU486NDPSS, ZGU486LDPSS	WB03K10274

**To order, call GE National Parts Center at 1.800.626.2002.**



### Grill grate, frame and baffle

(on some models)

The IR Grill should be cleaned immediately after each use.

#### 1. Clean the Grill Grate:

Turn the burner to OFF. Use a barbecue mitt to remove the hot grill grate. Place the grill grate in a basin or sink and scrub with a brass bristle brush. Rinse frequently.

The grill grate may also be cleaned in the oven during the self-cleaning cycle, or, it can be cleaned in the dishwasher.

#### 2. Clean the Grill Grate Frame:

The grill grate frame can be cleaned by hand or in the dishwasher. Do not clean the grill grate frame in a self-cleaning oven. The grill grate frame has rubber pads on each bottom corner. Be careful not to damage the pads during the cleaning process.

#### 3. Clean the Radiant baffle:

Lift the baffle out of the pan. Clean the baffle with hot soapy water or in the dishwasher.

#### 4. Clean the Pan Surround, Wire Mesh:

The pan surround and wire mesh cannot be removed. Clean them in place. Use a soft damp cloth to clean the pan surround. Gently brush food particles into the grease trough or use a vacuum cleaner for excess debris.

**IMPORTANT:** Keep the grill burner and ceramic igniter dry. Do not spray water or cleaner directly onto the wire mesh or igniter. Avoid contact with the igniter, it is fragile and can chip or break.

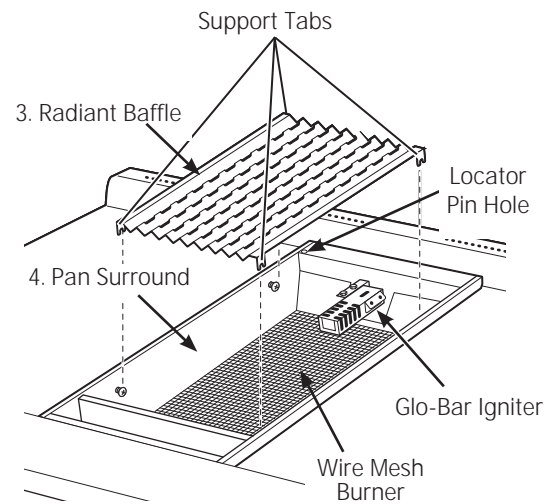
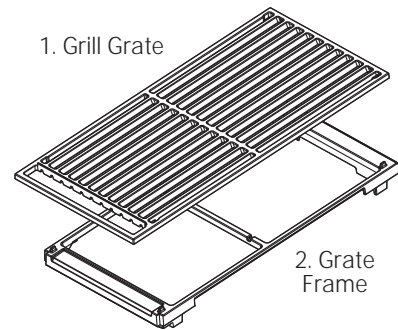

#### Reassemble the Grill:

Reverse the steps above to reassemble the grill. The radiant baffle support tabs should engage the pins on the side of the pan surround. Replace the grate frame. Be sure to engage the bottom locator pin with the pin hole at the left rear side of the pan. Replace the grill grate with the handle end towards the front of the rangetop.



# The Problem Solver

## Professional Rangetops

PROBLEM	POSSIBLE CAUSE
<b>BURNERS DO NOT LIGHT OR SPARK RANDOMLY</b>	<ul style="list-style-type: none"> <li>• Electrical plug is not plugged into a live power outlet.</li> <li>• Gas not turned on.</li> <li>• Burner parts not replaced correctly.</li> <li>• Holes in the simmer rings or slits in the burner rings are clogged.</li> <li>• Clogged orifice, or wet burners or electrodes.</li> </ul>
<b>BURNERS HAVE YELLOW OR YELLOW-TIPPED FLAMES</b>	<ul style="list-style-type: none"> <li>• Burner parts not replaced correctly.</li> </ul> <div style="display: flex; justify-content: space-around; align-items: center;">    </div> <p><b>A. Yellow flames:</b> <i>Call for service.</i>      <b>B. Yellow tips on outer cones:</b> <i>Normal for LP gas.</i>      <b>C. Soft blue flames:</b> <i>Normal for natural gas.</i></p> <ul style="list-style-type: none"> <li>• If burner flames look like <b>(A)</b>, call for service. Normal burner flames should look like <b>(B)</b> or <b>(C)</b>, depending on the type of gas.</li> </ul>
<b>BURNER FLAMES VERY LARGE OR YELLOW</b>	<ul style="list-style-type: none"> <li>• The rangetop may be connected to the wrong fuel type. Contact the person who installed your rangetop or made the conversion.</li> </ul>
<b>BURNER CONTROL KNOB WILL NOT TURN</b>	<ul style="list-style-type: none"> <li>• When the knob is at the <b>OFF</b> position, it must be pushed in before it can be turned, and it can only be turned in a <b>counterclockwise</b> direction. When the knob is at any other position, it can be turned in either direction without being pushed inwards.</li> </ul>

**With the purchase of your new GE Café appliance, receive the assurance that if you ever need information or assistance from GE, we'll be there. All you have to do is call—toll-free!**

**GE Answer Center®**

**In the USA:  
800.626.2000**

Whatever your question about any GE Café major appliance, GE Answer Center® information service is available to help. Your call—and your question—will be answered promptly and courteously. Call the GE Answer Center® Monday to Friday, 8 a.m. to 10 p.m. EST, and Saturday, 8 a.m. to 7 p.m. EST.

**OR**

Visit our Website at: **GEAppliances.com**

In Canada, call 800.561.3344.

**In-Home  
Repair Service**

**In the USA:  
800.444.1845**

**In Canada:  
800.561.3344**

A GE consumer service professional will provide expert repair service, scheduled at a time that's convenient for you. To schedule service, call Monday to Friday, 7 a.m. to 10 p.m. EST, or Saturday and Sunday, 8 a.m. to 6 p.m. EST. Many GE Consumer Service company-operated locations offer you service today or tomorrow, or at your convenience. Our factory-trained technicians know your appliance inside and out—so most repairs can be handled in just one visit.

In Canada: Monday to Friday, 7:00 a.m. to 8:00 p.m. and Saturday, 8:00 a.m. to 5:00 p.m. EDT.

**For Customers With  
Special Needs...**

**In the USA:  
800.626.2000**

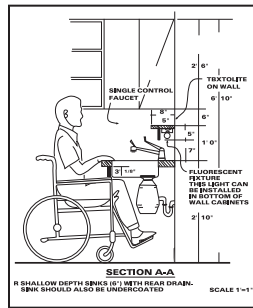

GE offers, free of charge, a brochure to assist in planning a barrier-free kitchen for persons with limited mobility.

Consumers with impaired hearing or speech who have access to a TDD or a conventional teletypewriter may call 800.TDD.GEAC (800.833.4322) to request information or service.

**Service Contracts**

**In the USA:  
800.626.2224**

**In Canada:  
800.561.3344**

You can have the secure feeling that GE Consumer Service will still be there after your warranty expires. Purchase a GE contract while your warranty is still in effect and you'll receive a substantial discount. With a multiple-year contract, you're assured of future service at today's prices.

**Parts and  
Accessories**

**In the USA:  
800.626.2002**

**In Canada:  
800.561.3344**

**Individuals qualified to service their own appliances** can have parts or accessories sent directly to their home. The GE parts system provides access to over 47,000 parts...and all GE Genuine Renewal Parts are fully warranted. VISA, MasterCard and Discover cards are accepted.

**User maintenance instructions contained in this manual cover procedures intended to be performed by any user. Other servicing generally should be referred to qualified service personnel. Caution must be exercised, since improper servicing may cause unsafe operation.**

## Thank You! ... for your purchase of a GE Brand appliance.

**Register Your Appliance:** Register your new appliance on-line at your convenience!

[www.geappliances.com/service\\_and\\_support/register/](http://www.geappliances.com/service_and_support/register/)

Timely product registration will allow for enhanced communication and prompt service under the terms of your warranty, should the need arise. You may also mail in the pre-printed registration card included in the packing material.

## GE Gas Cooktop Warranty

### GEAppliances.com

All warranty service is provided by our Factory Service Centers, or an authorized Customer Care® technician. To schedule service, on-line, visit us at [www.geappliances.com/service\\_and\\_support/](http://www.geappliances.com/service_and_support/), or call 800.GE.CARES (800.432.2737). Please have serial number and model number available when calling for service.

Servicing your appliance may require the use of the onboard data port for diagnostics. This gives a GE factory service technician the ability to quickly diagnose any issues with your appliance and helps GE improve its products by providing GE with information on your appliance. If you do not want your appliance data to be sent to GE, please advise your technician not to submit the data to GE at the time of service.

For the period of one year from the date of the original purchase. GE will provide any part of the range which fails due to a defect in materials or workmanship. During this limited one-year warranty, GE will also provide, free of charge, all labor and in-home service to replace the defective part.

### What GE will not cover:

- Service trips to your home to teach you how to use the product.
- Improper installation, delivery or maintenance.
- Failure of the product if it is abused, misused, modified or used for other than the intended purpose or used commercially.
- Replacement of house fuses or resetting of circuit breakers.
- Damage to the product caused by accident, fire, floods or acts of God.
- Incidental or consequential damage caused by possible defects with this appliance.
- Damage caused after delivery.
- Product not accessible to provide required service.
- Service to repair or replace light bulbs, except for LED lamps.

### EXCLUSION OF IMPLIED WARRANTIES

Your sole and exclusive remedy is product repair as provided in this Limited Warranty. Any implied warranties, including the implied warranties of merchantability or fitness for a particular purpose, are limited to one year or the shortest period allowed by law.

This warranty is extended to the original purchaser and any succeeding owner for products purchased for home use within the USA. If the product is located in an area where service by a GE Authorized Servicer is not available, you may be responsible for a trip charge or you may be required to bring the product to an Authorized GE Service location for service. In Alaska, the warranty excludes the cost of shipping or service calls to your home.

Some states do not allow the exclusion or limitation of incidental or consequential damages. This warranty gives you specific legal rights, and you may also have other rights which vary from state to state. To know what your legal rights are, consult your local or state consumer affairs office or your state's Attorney General.

**Warrantor: General Electric Company. Louisville, KY 40225**

**Extended Warranties:** Purchase a GE extended warranty and learn about special discounts that are available while your warranty is still in effect. You can purchase it on-line anytime

[www.geappliances.com/service\\_and\\_support/shop-for-extended-service-plans.htm](http://www.geappliances.com/service_and_support/shop-for-extended-service-plans.htm)

or call 800.626.2224 during normal business hours. GE Consumer Home Services will still be there after your warranty expires.

Staple your receipt here. Proof of the original purchase date is needed to obtain service under the warranty.