

1. IMPORTANT SAFETY INSTRUCTIONS	4
2. BEFORE USING YOUR RANGE FOR THE FIRST TIME	5
3. DESCRIPTION OF THE RANGE CONTROLS	9
4. AVAILABLE ACCESSORIES	11
5. USING THE RANGETOP	12
6. USING THE OVEN	15
7. SUGGESTIONS FOR COOKING	17
8. CLEANING AND MAINTENANCE	22
9. SPECIAL MAINTENANCE	25

WARNING: If the instructions contained in this manual are not followed precisely, fire or explosion may result causing property damage, personal injury or loss of life.

- Do not store or use gasoline or other flammable vapors or liquids near this or any other appliance.

WHAT TO DO IF YOU SMELL GAS

- Do not try to light any appliance.
 - Do not touch any electrical switches.
 - Do not use any telephones in your building.
 - Immediately call your gas supplier from a neighbor's phone. Follow the gas supplier's instructions.
 - If you cannot reach your gas supplier, call the fire department.
- Installation and service must be performed by a qualified installer, service agency or gas supplier.



NOTE: THIS APPLIANCE MUST BE INSTALLED SOLELY AND EXCLUSIVELY BY A QUALIFIED TECHNICIAN. ANY TECHNICAL PROCEDURES MUST BE CARRIED OUT BY AN AUTHORIZED TECHNICIAN.



INSTRUCTIONS FOR THE USER: these instructions contain user advice, a description of the controls and the correct procedures for cleaning and maintenance of the appliance.

1. IMPORTANT SAFETY INSTRUCTIONS



READ AND SAVE THESE INSTRUCTIONS – Your safety and the safety of others are very important. We have provided many important safety messages throughout this manual and on the appliance. Read all the instructions before using the appliance and always obey all safety messages.



RECOGNIZE SAFETY INFORMATION

This is a safety alert symbol. This symbol alerts you to potential hazards that can result in severe personal injury or loss of life.

UNDERSTAND SIGNAL WORDS

A signal word – DANGER, WARNING, or CAUTION – is used with the safety alert symbol. DANGER denotes the most serious hazards. It means you could lose your life or be seriously injured if you do not immediately follow the instructions. WARNING means you could lose your life or be seriously injured if the instructions are not followed. CAUTION indicates a potentially hazardous situation which, if not avoided, could result in minor to moderate injury.



WARNING

- This appliance is intended for use in the home only.
- Use this appliance only for its intended purpose. The manufacturer cannot be held liable for damage caused by improper use of this range.
- This appliance complies with current safety regulations. Improper use of this range can result in personal injury and material damage.
- Read all the instructions before installing or using the range for the first time.
- Keep these operating instructions in a safe place and pass them on to any future user.

The safety messages will inform you of potential hazards, on how to avoid the risk of injury and what can occur if the instructions are not followed.

IMPORTANT: Observe all governing codes and ordinances. Refer to the Installation Manual for instructions on installing the appliance.



NOTE: This range is manufactured for use with natural gas. To convert the appliance to LP/Propane gas, see the instructions in the Gas Conversion Kit provided in the literature package.

The proper gas supply connection must be available. See "Gas supply requirements".

WARNING: for your safety, the information in this manual must be followed to minimize the risk of fire or explosion, or to prevent property damage, personal injury or death



Do not store or use gasoline or other flammable vapors, liquids or materials near this or any other appliance.

2. BEFORE USING YOUR RANGE FOR THE FIRST TIME

TIP OVER HAZARD

 **WARNING**

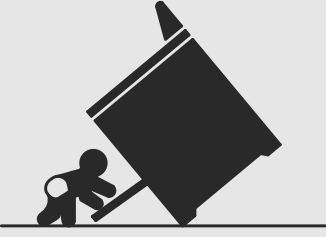

- A child or adult can tip the range and be killed.
- Make sure that the anti-tip device has been properly installed and engaged. The wall-mounted brackets should anchor the sides of the range (primary system) or, in case of floor-mounted brackets, they should anchor the rear of the range to the ground.
- Make sure that the anti-tip device is re-engaged when the range is moved. The wall-mounted brackets should anchor the sides of the range (primary system) or, in case of floor-mounted brackets, they should anchor the rear of the range to the ground.
- Do not operate the range without the anti-tip device in place and engaged.
- Failure to do so can result in death or serious burns to children or adults.

 **WARNING**

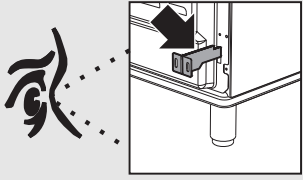

PRIMARY FASTENING SYSTEM:
Visually check that the wall-mounted brackets are inserted into the appropriate lateral hooks (on both sides).

 **NOTE:** This range is NOT designed for installation in manufactured (mobile) homes or in recreational vehicles (RVs).

DO NOT install this range outdoors.

 **WARNING** **To reduce the risk of fire, electrical shock, personal injury, or damage when using the range, follow basic safety precautions, including the following:**



- Proper installation is your responsibility. Make sure your appliance is properly installed and grounded by a qualified installer.



- **WARNING: NEVER** use this appliance as a space heater to heat or warm the room. Doing so may result in carbon monoxide poisoning and overheating of the oven.



- **DO NOT LEAVE CHILDREN UNATTENDED:** Children should not be left alone or unattended in the area where the appliance is being used. Never allow children to sit or stand on any part of the appliance.

- Do not store items of interest to children in the area where the appliance is in use. If children are allowed to use the appliance, they must be closely supervised by an adult.

- **WEAR PROPER APPAREL:** loose-fitting or hanging garments should never be worn while using the appliance.

- For safety reasons and to avoid damage to your appliance, never sit, stand or lean on the oven door.



- FLAMMABLE MATERIALS SHOULD NEVER BE STORED IN THE OVEN OR NEAR THE SURFACE BURNERS.

- GREASE IS FLAMMABLE: Allow hot grease to cool before attempting to handle it. Do not allow deposits of grease to accumulate.



- DO NOT USE WATER ON GREASE FIRES: Turn the appliance off and smother the fire with baking soda or use a dry chemical or a foam-type extinguisher.

- USE ONLY DRY POTHOLDERS: Moist or damp potholders on hot surfaces may cause burns from steam. Do not allow potholders to touch hot surface burners. Do not use towels or other bulky cloth in place of potholders.

- Never allow garments, potholders or other flammable materials to come into direct or indirect contact with burners until they have completely cooled.



- DO NOT TOUCH SURFACE BURNERS OR THE INSIDE OF THE APPLIANCE: Heating elements may be hot even though they are dark in color. The oven cavity can be hot enough to cause burns. During and after use, do not touch areas near burners or the inside of the oven until they have had sufficient time to cool. Do not allow garments or any flammable material to come into contact with hot surfaces. If personal clothing or hair catches on fire, drop and roll immediately to extinguish the flames.

- PLACE THE OVEN RACKS IN THE DESIRED POSITION WHILE THE OVEN IS COOL: If a rack must be removed while the oven is hot, do not allow the potholders to come in contact with the broiler burner.



- USE CAUTION WHEN OPENING THE OVEN DOOR: Allow hot air or steam to escape before removing or placing foods in the oven.



- Do not leave the packing materials around the home. Sort the various items of waste and take them to the nearest specialized waste collection facility.



- Do not obstruct oven vents or openings for air intake.

- ELECTRICAL GROUNDING IS REQUIRED. It is the customer's responsibility:

a) To contact a qualified electrician.

b) To ensure that the electrical system is adequate and in compliance with the National Electrical Code ANSI / NFPA 70 Electrical Code – latest edition – Or the CANADIAN ELECTRICAL CODE, C22.11 – 1982 and C22.2 No. 01982 – or latest edition – and all local codes and ordinances.

- Always check that the controls are in the "zero" (off) position when the range is not in use.

- Use only pots or pans with a perfectly smooth, flat bottom on the range surface burners. NEVER USE THE RANGETOP AS A WORK SURFACE.

- Do not attempt to repair or replace any part of this appliance unless specifically recommended in this manual. All other servicing should be done by a qualified technician.
- Never use any part of the range or oven for storage. Flammable materials can ignite and plastic items may melt or burst into flame.
- Do not hang articles on any part of the appliance or place anything against the oven. Some fabrics are extremely flammable and could ignite.
- **DO NOT USE ALUMINUM FOIL TO LINE ANY PART OF THE OVEN OR RANGETOP.** Use of a foil liner can result in an electrical shock or fire hazard or obstruct the flow of heat and air. Foil is an excellent heat insulator, allowing heat to be trapped under it. This can interfere with cooking and can damage the enamel of the oven.
- Never leave the range unattended when using high heat settings. Boilover can cause smoke and spattered grease can ignite.
IMPORTANT: After a spill or boilover, turn off the burner and clean around it. After cleaning, check that the burner functions properly.
- Not all types of glass, thermally resistant glass-ceramic, ceramic, earthenware, or other glazed cookware are suitable for range use. This type of cookware can break with sudden temperature changes. Use only on low or medium heat settings in accordance with the instructions supplied by the manufacturer.
- **DO NOT HEAT UNOPENED FOOD CONTAINERS:** A buildup of pressure can cause the containers to burst.
- **DO NOT USE FLAMMABLE PRODUCTS TO CLEAN THE RANGE.**
- Do not clean, rub, damage or remove the oven door gasket. It is essential for a good, tight seal during baking and when the self-clean cycle is engaged. Replace the oven door gasket if it becomes damaged or encrusted with food residue.
- Be sure all range surface burners controls are turned off and that the rangetop is cool before using any type of cleaning product. The chemical elements in these products could, in the presence of heat, ignite or cause metal parts to corrode.
- **ONLY QUALIFIED SERVICE PERSONNEL SHOULD PERFORM REPAIRS.** Service personnel must disconnect the power supply before servicing this unit.



NOTE: The California Safe Drinking Water and Toxic Enforcement Act requires the Governor of California to publish a list of substances known to the State of California to cause cancer, birth defects or other reproductive harm, and requires businesses to warn customers of potential exposure to such substances.

WARNING: This product contains a chemical known by the State of California to cause cancer, birth defects or other reproductive harm.

This appliance can cause low-level exposure to some of the substances listed, including benzene, formaldehyde, carbon monoxide, toluene, and soot.

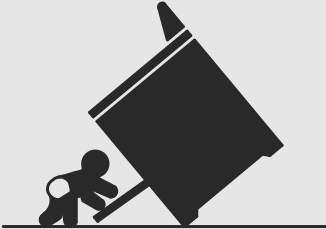
 **WARNING****TIP OVER HAZARD**

- A child or adult can tip the range and be killed.
- Make sure that the anti-tip device has been properly installed and engaged. The wall-mounted brackets should anchor the sides of the range (primary system) or, in case of floor-mounted brackets, they should anchor the rear of the range to the ground.
- Make sure that the anti-tip device is re-engaged when the range is moved. The wall-mounted brackets should anchor the sides of the range (primary system) or, in case of floor-mounted brackets, they should anchor the rear of the range to the ground.
- Do not operate the range without the anti-tip device in place and engaged.
- Failure to do so can result in death or serious burns to children or adults.

MAKE SURE THAT YOUR RANGE IS PROPERLY SECURED AND THE ANTI-TIP DEVICE IS CORRECTLY INSTALLED. REFER TO THE INSTRUCTIONS INSIDE THE INSTALLATION MANUAL.

- Do not stand or sit on the oven door or drawer.
- Remove all packing materials and temporary labels from the oven and rangetop.
- Record the Model and Serial number on Page 2 of this booklet. The Model and Serial numbers are on the Range ID plate, which is positioned in a visible area in the storage compartment. THE ID PLATE MUST NOT BE REMOVED.
- BEFORE BAKING OR BROILING FOR THE FIRST TIME, turn on the oven and broiler to burn off any dirt, oil or grease remaining from the manufacturing process. Turn the oven on and set to 450°F (230°C) for 20 to 30 minutes, then turn on the broiler for the same amount of time.

SAVE THESE INSTRUCTIONS



3. DESCRIPTION OF THE RANGE CONTROLS

All the range selectors and controls are located on the front panel.

FRONT CONTROL PANEL

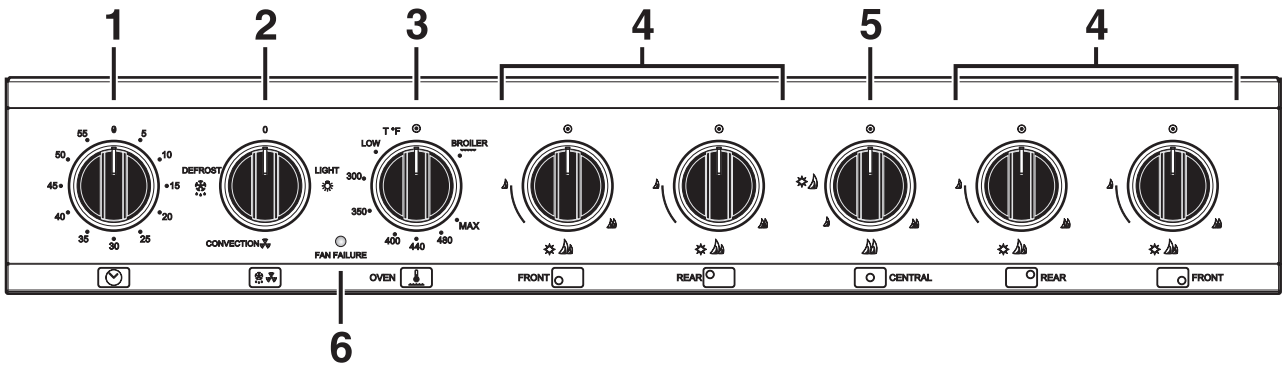

TIMER CONTROL KNOB

- 1** This knob is used to set a timer. The numbers correspond to minutes. Adjustment is progressive so that the time can also be set to any intermediate value between the indicated numbers. A buzzer will sound when the time expires, but the cooking process will not be interrupted.

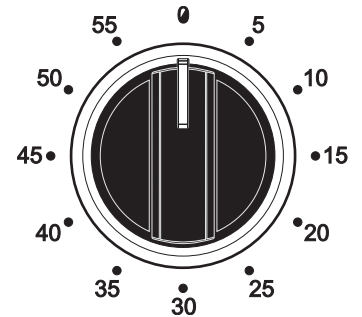

OVEN FUNCTION SELECTOR KNOB

- 2** Turn this knob to select from the following functions:



NO FUNCTION SELECTED: In this position, none of the three oven functions presented below can be activated.



DEFROST: Turn the knob to this position to defrost food.



OVEN LIGHT: Turn the knob to this position to turn on the light inside the oven.



CONVECTION: Turn the knob to this position to turn on the oven convection system. Use this setting to cook with forced air.

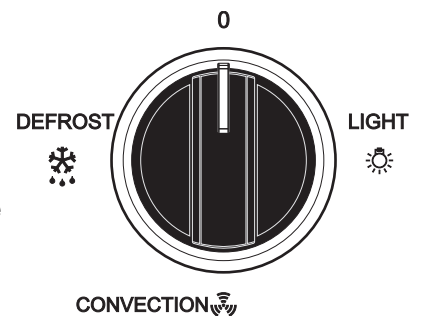





OVEN BURNER CONTROL KNOB

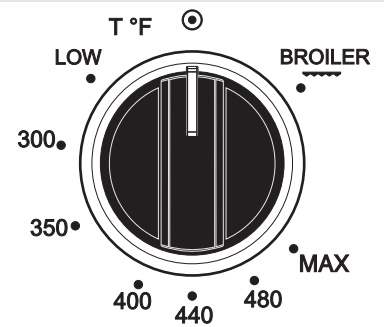

- 3** This knob is used to light the oven burner inside the oven and to regulate the desired **temperature** for cooking.

Turn the knob counterclockwise to the desired temperature. When lighting the oven, it is recommended to leave the oven door partially open.



RANGETOP BURNER COMMAND KNOB

- 4** Push and turn the appropriate knob counterclockwise to the simmer flame symbol  to light burners.



To adjust the flame, turn the knob to any position between the maximum  and minimum marks .

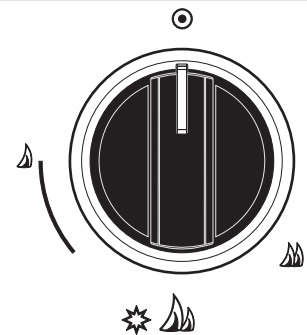

To light surface burners, push and turn the appropriate knob counterclockwise to the simmer flame symbol .

To turn off, turn the knob to the  position.



CENTRAL BURNER COMMAND KNOB

- 5** Push and turn this knob counterclockwise to the large flame symbol  to light the central part of the burner. Turn the knob to the double flame symbol  to also light the external part of the burner.

Turn the knob to any position between the maximum  and minimum marks .

To turn off, turn the knob to the  position.

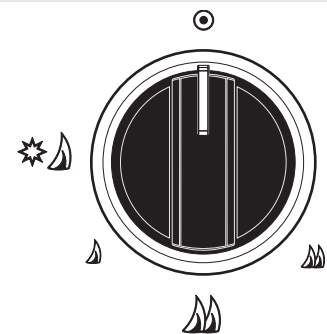

INDICATOR LIGHT

- 6** This light indicates a malfunction in the cooling system or temporary overheating. If the light remains constantly on, call an authorized repair service.



NOTE: Do not use the appliance when the FAN FAILURE light remains constantly on.



4. AVAILABLE ACCESSORIES

The oven features **4 rack supports** for arranging oven trays and racks at different heights.

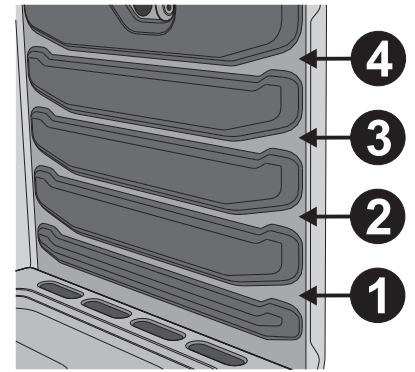

Oven rack: for cooking food on oven trays, small cakes, roasts or food requiring light broiling.

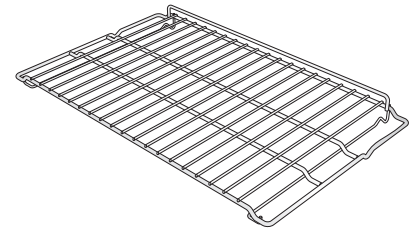

Oven tray: for catching grease and oil from foods placed on the rack above and for baking cakes, pizza and desserts.

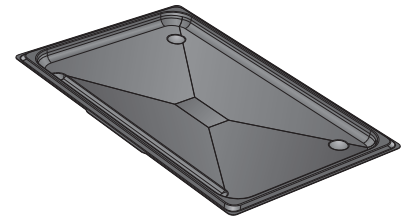

The oven accessories which may come into contact with foods are made from materials compliant with that required by the current regulations.

4.1 Using the rack or tray

The racks and trays are equipped with a mechanical safety lock which prevents them from being accidentally taken out. To insert the rack or tray correctly, check that the lock is facing downwards (as shown in the figure alongside).

To remove the rack or tray, lift the front slightly.

The mechanical lock (or raised rack, where present) must always face the back of the oven.

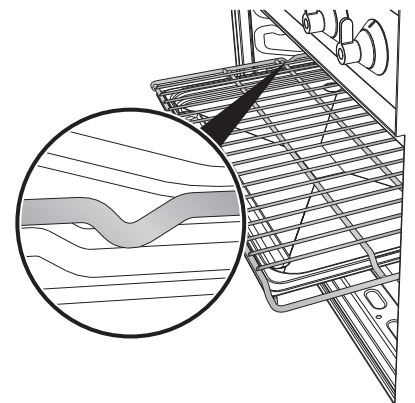

Gently insert the racks and trays into the oven until they come to a stop.



Clean the trays before using them for the first time. Cleaning prevents any manufacturing residues from leaving mild scratches on the side walls of the oven when the tray is inserted.



5. USING THE RANGETOP

FIRE HAZARD

! WARNING



- Do not allow the burner flame to extend beyond the edge of the pan.

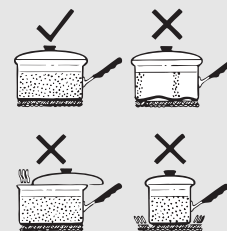

- Turn off all controls when the range is not in use.

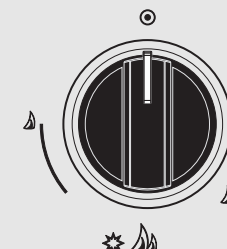

NOTE: Check that the burner heads, burner caps and grates are correctly positioned. Before lighting the rangetop burners, check that each burner head is correctly positioned with its respective burner cap.

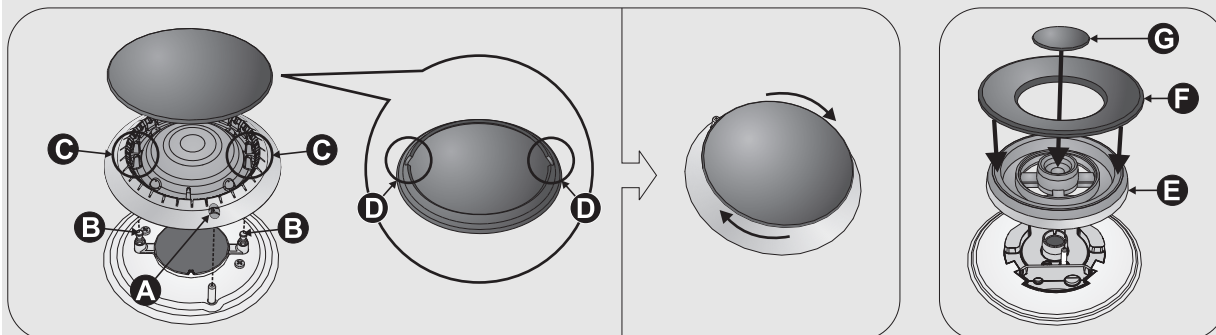

Align slot **A** with the igniter and ensure that the pins **B** line up with slots **C**. Align the flarings **D** of the burner cap to the pins **B** and when positioned on the burner, rotate the burner cap slightly to ensure that it is stable.

For the dual burner, place the burner cap **G** and **F** on the burner head **E**, ensuring that they fit snug. The burner head must be put on (taking care to use the spark electrode as a guide).

5.1 Ignition safety device



Each burner knob has a marking corresponding to the burner it controls (the example at the left, shows the front left burner).

The appliance is equipped with spark electrode ignition.

- Just turn the knob counterclockwise to the simmer flame symbol  until the burner turns on.



NOTE: If the flame accidentally goes out, an automatic system will attempt to relight it. If the attempt to relight it is unsuccessful, an internal safety device will block the flow of gas. To restore the correct operation of the lighting system, return the knob to the position  and repeat the procedure.

REMEMBER: When the rangetop is in use, the entire range area may become hot.



NOTE: Do not try to manually relight the flame.



5.2 Practical advice on using the rangetop burners



NOTE: Do not obstruct the flow of heat and ventilation around the edges of the grate.



For more efficient use of the burners and lower gas consumption, use covered cookware that is proportional in size to the burner to prevent the flame from extending beyond the sides (see paragraph "5.3 Cookware diameter"). When water begins to boil, lower the flame so that it does not boil over. To avoid burns or damage to the rangetop, all pots, pans or griddles must be placed within the perimeter of the rangetop. All cookware must have a flat and smooth bottom. When cooking with grease or oil, be extremely careful to avoid overheating and a potential grease fire. If the flame accidentally goes out, turn the control knob to off and wait at least 1 minute before trying to relight the burner.



NOTE: Before turning on a burner, place filled cookware on the grate. Do not operate a burner with empty cookware or without placing the cookware on the grate.

Do not leave empty cookware on a hot surface or burner.



NOTE: No attempt should be made to operate the appliance during a power failure.

5.3 Cookware diameter



BURNERS	Ø min. and max. (cm)	Ø min. - max. (inches)
1 Fast	18 - 26	7 1/8" - 10 1/4"
2 Ultra fast	20 - 26	7 7/8" - 10 1/4"



5.4 Cookware



NOTE: Do not leave empty cookware on a hot surface or burner.

Ideally, cookware should have a flat bottom, straight sides, a tight-fitting lid and medium-to-heavy thickness.

Rough cookware finishes may scratch the rangetop. Aluminum and copper may be used in cookware as a core material or base. However, when used as a base they can leave permanent marks on the rangetop or grates.

Cookware properties are a factor in how quickly and evenly heat is distributed, which affects cooking results. A non-stick finish has the same characteristics as its base material. For example, a non-stick finish on Aluminum cookware will take on the properties of aluminum.

Refer to the following chart as a guide to the physical properties of cookware.

COOKWARE	PROPERTIES
Aluminum	<ul style="list-style-type: none"> • Heats quickly and evenly • Suitable for all types of cooking • Medium or heavy thickness is best for most cooking tasks.
Cast iron	<ul style="list-style-type: none"> • Heats slowly and evenly • Good for browning and frying • Maintains heat for slow cooking.
Ceramic or glass-ceramic	<ul style="list-style-type: none"> • Follow the manufacturer's instructions • Heats slowly but unevenly • Best results with low to medium heat settings.
Copper	<ul style="list-style-type: none"> • Heats very quickly and evenly
Earthenware	<ul style="list-style-type: none"> • Follow the manufacturer's instructions • Use low heat settings
Porcelain enameled steel or cast iron	<ul style="list-style-type: none"> • See stainless steel or cast iron
Stainless steel	<ul style="list-style-type: none"> • Heats quickly but unevenly • Stainless steel cookware with aluminum or copper as a core material or bottom provides even heating.



6. USING THE OVEN

6.1 General Instructions



NOTE: Before using the oven for the first time, pre-heat it to the maximum temperature (530°F), and operate long enough to burn away any oily residue remaining from the manufacturing process that could give the food a bad taste.



WARNING



BURN HAZARD

To prevent burns caused by steam in the oven, open the door in two stages: partially open (approximately 5 cm or 2 inches) for 4- 5 seconds, long enough to permit the steam to escape, and then fully open.

When accessing the food in the oven, always leave the door open the shortest possible time to prevent the oven temperature from falling and ruining the food.



WARNING



Never cover any slots, ports or orifices in the oven bottom or cover an entire rack with materials such as aluminum foil. Doing so blocks air flow through the oven and may lead to carbon monoxide poisoning. Aluminum foil linings may also trap heat, creating a fire hazard.



NOTE: If the flame accidentally goes out, an internal safety device will block the flow of gas. To restore the correct operation of the lighting system, return the knob to the position  and repeat the procedure.



NOTE: Do not attempt to manually light the oven or the broil burner.



NOTE: The broil and oven burners cannot be operated simultaneously.



NOTE: No attempt should be made to operate the appliance during a power failure.



6.2 Convection cooking

To use convection, light the oven burner using the oven ignition knob and then turn the oven function selector to the position indicated by a . The convection system activates when the selected temperature is reached.



WARNING: Do not use the defrost function (indicated by the  symbol) for convection cooking. Because there is no time delay associated with engaging the defrost function, it could cause a serious appliance malfunction.



WARNING: Convection cooking cannot be used for broiling.

6.3 Oven light

It illuminates when the function selector knob is turned to the oven light setting .



NOTE: Do not obstruct the air intake vents located on the upper part of the storage compartment.



7. SUGGESTIONS FOR COOKING



WARNING

BURN HAZARD



Keep the oven door closed during cooking.



WARNING

Do not line the bottom of the oven with aluminum or tin foil or place pans or oven trays on this surface as this may damage the enamel oven lining. If you wish to use waxed paper in the oven, position it so that it does not interfere with the circulation of hot air inside the oven.



NOTE: In fan-assisted mode, the oven should be preheated to 90-100°F above the recommended cooking temperature. This considerably shortens the cooking time, reduces power consumption and provides more even cooking.

7.1 Conventional cooking



FUNCTION SELECTOR



CONTROL KNOB FROM LOW TO MAX

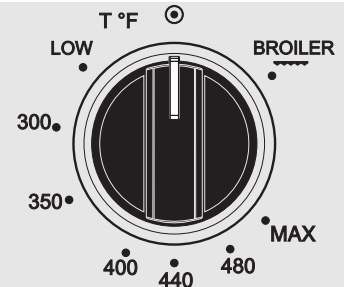

In conventional cooking, heat circulates from bottom to top; this is ideal for cooking food on a single rack. Preheat the oven to the desired temperature and put the food in the oven only after the thermostat light has gone out. Very fatty meats may be put in when the oven is still cold. Frozen meat can be placed directly in the oven without waiting for it to thaw. However, set the temperature about 70°F lower and allow 25% more time for cooking.

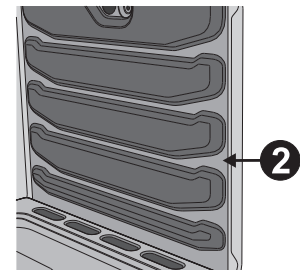

NOTE: Use pans with deep sides to prevent oil/grease from splattering and soiling the walls of the oven.





7.2 Convection cooking



FUNCTION SELECTOR



CONTROL KNOB FROM LOW TO MAX

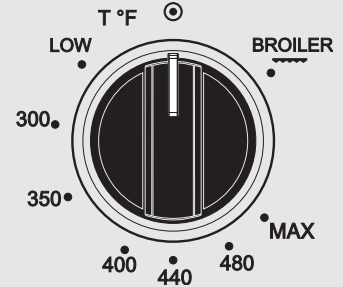

Convection can be used to cook food simultaneously on several rack positions, even when different types of food (fish, meat etc.) are used, without mixing tastes and aromas. Air circulation in the oven ensures a uniform distribution of heat. Pre-heating is not necessary.

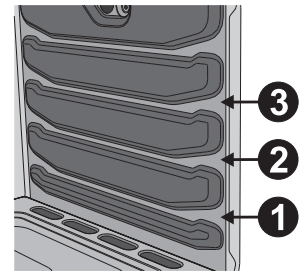

NOTE: Simultaneous cooking of multiple foods is possible as long as the cooking temperature required for the different foods is the same.

7.3 Broiler



FUNCTION SELECTOR

BROILER

CONTROL KNOB TO BROILER POSITION

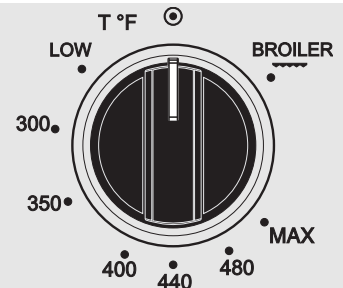

Browns food rapidly. It is recommended that the broiling pan be placed on the 3rd rack.

For short cooking times or small quantities, place the rack on the third runner from the bottom. For longer cooking times and for broiling, put the rack on the lowest runner depending on the size of the food.

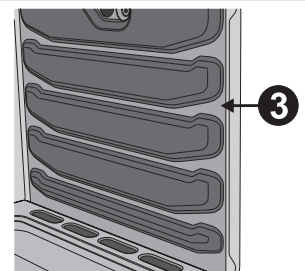

NOTE: Keep the oven door closed during cooking.



7.4 Defrosting

FUNCTION SELECTOR		
CONTROL KNOB ON THE DEFROST SETTING		

The flow of air generated by the fan ensures rapid defrosting. The air circulating inside the oven is at room temperature.

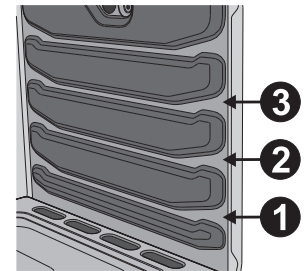

NOTE: The advantage of defrosting at room temperature is that it does not alter the taste or appearance of the food.



7.5 Recommended cooking chart

Cooking times, especially for meats, can vary according to the thickness and quality of the food as well as personal taste.

CONVENTIONAL COOKING			
	RACK POSITION	TEMPERATURE (°F)	TIME IN MINUTES (*)
FIRST COURSES			
LASAGNA	2 - 3	390 - 410	50 - 60
OVEN-BAKED PASTA	2 - 3	410 - 450	40
MEAT			
VEAL ROAST	2	350 - 390	15 - 20 /LB.
BEEF ROAST	2	410 - 470	15 - 20 /LB.
PORK ROAST	1 - 2	350 - 400	100 - 110
CHICKEN	1 - 2	350 - 400	80 - 90
DUCK	2	350 - 400	110 - 130
GOOSE - TURKEY	2	300 - 350	45 - 60
RABBIT	2	350 - 400	100 - 120
LEG OF LAMB	2	350 - 400	40 - 50
FISH	1	338 - 392	ACCORDING TO THE SIZE OF THE FISH
PIZZA	1 - 2	430 - 470	20 - 25
DESSERTS			
SMALL PASTRIES	1 - 2	340 - 400	15 - 20
BUNDT CAKE	1 - 2	340	60 - 70
TARTS	1	360 - 400	30 - 40
FRUIT CAKE	1 - 2	340 - 400	20 - 30
ANGEL CAKE	1 - 2	320	60
APPLE CAKE	1	400	60
RICE CAKE	1	360	60 - 70

(*) = PREHEATED OVEN

BROIL			
	RACK POSITION	TIME IN MINUTES (*)	
		FIRST SIDE	SECOND SIDE
PORK CHOPS	3	7 - 9	5 - 7
FILLET OF PORK	3	9 - 11	5 - 9
FILLET OF BEEF	3	9 - 11	9 - 11
LIVER	3	2 - 3	2 - 3
VEAL CHOPS	3	7 - 9	5 - 7
HALF CHICKEN	3	9 - 14	9 - 11
SAUSAGES	3	7 - 9	5 - 6
MEATBALLS	3	7 - 9	5 - 6
FILLET OF FISH	3	5 - 6	3 - 4
TOAST	3	2 - 4	2 - 3

**CONVECTION COOKING**

	RACK POSITION	TEMPERATURE (°F)	TIME IN MINUTES (*)
FIRST COURSES			
LASAGNA	2	370 - 400	40 - 50
OVEN-BAKED PASTA	2	370 - 400	25 - 30
MEAT			
VEAL ROAST	1 - 2	300 - 340	65 - 90
PORK ROAST	1 - 2	300 - 320	70 - 100
BEEF ROAST	1 - 2	320 - 340	65 - 90
FILLET OF BEEF	1 - 2	320 - 360	35 - 45
ROASTED LAMB	1 - 2	270 - 300	100 - 130
BEEF ROAST	1 - 2	340 - 360	40 - 45
ROASTED CHICKEN	1 - 2	340	70 - 80
ROASTED DUCK	1 - 2	340 - 360	100 - 120
ROASTED TURKEY BREAST	1 - 2	320 - 340	90
ROASTED RABBIT	1 - 2	320 - 340	80 - 100
ROASTED HARE	1 - 2	320 - 340	30 - 50
ROASTED PIGEON	1 - 2	280 - 340	15 - 25
FISH	2 - 3	302 - 338	ACCORDING TO THE SIZE OF THE FISH
PIZZA	2 - 3	410 - 450	15 - 20
BREAD	2 - 3	370 - 400	40
TOAST	1 - 2	430 - 470	7
DESSERTS			
BUNDT CAKE	2 - 3	300 - 340	35 - 45
FRUIT CAKE - FRUIT FLAN	2 - 3	340 - 380	65 - 40
TARTS	2 - 3	320 - 340	20 - 25
SMALL PASTRIES	2 - 3	340 - 360	20
RICE CAKE	2 - 3	340	50 - 60
APPLE CAKE	2 - 3	360	60
ANGEL CAKE	2 - 3	320	60

(*) = PREHEATED OVEN



8. CLEANING AND MAINTENANCE



WARNING

ELECTRICAL SHOCK HAZARD



Before servicing the oven, disconnect the appliance from the power supply.

8.1 Cleaning stainless steel parts



NOTE: To keep stainless steel in good condition it should be regularly cleaned after use. Let steel parts cool first.

8.1.1 Routine Daily Cleaning

To clean and preserve stainless steel surfaces, use **only** specific products that do not contain abrasives or chlorine-based acids.

How to use: pour the product onto a damp cloth and wipe the surface, then rinse thoroughly and dry with a soft cloth or deerskin.

8.1.2 Food stains or residues

Do not use metallic scouring pads or sharp scrapers: they will damage the surface of the appliance.

Use standard non-abrasive products and a wooden or plastic scraping tool if necessary. Rinse thoroughly and dry with a soft cloth or deerskin.

Do not allow residues of sugary foods (such as jam) to set inside the oven. If allowed to set for too long, it will pit the enamel lining of the oven.





8.2 Cleaning of rangetop parts

8.2.1 Grates

Remove the grates. Clean with warm water and non-abrasive detergent, removing any crusty build-up. Replace the grates on the rangetop.

8.2.2 Burner caps, burner heads and burners

The burner caps and burner heads can be removed for easier cleaning. Wash them in hot water and with non-abrasive detergent, ensuring that all deposits are removed, and set them aside for complete drying.



NOTE: Replace the burner caps on the burner heads, making sure that the slots A are perfectly aligned with the projections on the burners.

Never wash these parts in the dishwasher.

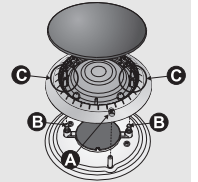

8.2.3 Spark electrodes

For best performance, the spark electrode must always be kept very clean. Check them frequently and, if necessary, wipe down with a damp cloth. Remove any burnt residue with a wooden toothpick or a straight pin or needle.

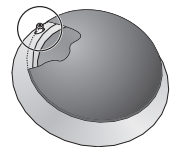



8.3 Cleaning the oven



NOTE: To ensure the longevity of your appliance, the oven should be cleaned regularly. Allow the oven to cool before cleaning.

- Take out all removable parts.
- Clean the oven racks with hot water and non-abrasive detergent. Rinse and dry.
- For easier cleaning, the door can be removed (see paragraph “9.1 Removing the door”).

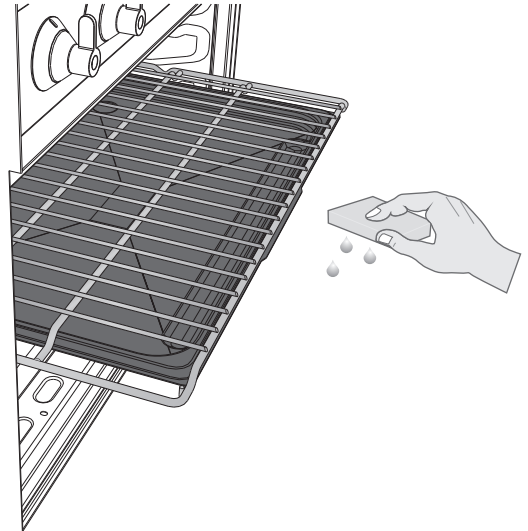

8.4 Oven door glass

The oven door glass should always be kept clean. Use absorbent kitchen paper towel to clean. In case of tough spots, clean with a damp sponge using a standard household detergent.



NOTE: Do not use abrasive or corrosive cleaners to clean the oven door glass (e.g. powders, spray-on oven cleaners, stain removers or steel wool pads). Do not use rough or abrasive materials or sharp metal scrapers to clean the oven door glass as they can scratch the surface or cause the glass to break.



9. SPECIAL MAINTENANCE

The oven may require special maintenance or replacement of parts subject to wear such as gaskets, bulbs, etc. The following instructions describe how to perform these minor maintenance operations.



WARNING

ELECTRICAL SHOCK HAZARD



Before servicing, disconnect the appliance from the power supply.

9.1 Removing the door

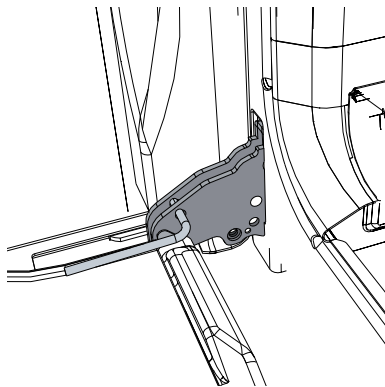

Open the door completely. Insert a pin in the hole in the hinge. Repeat this operation on both hinges.

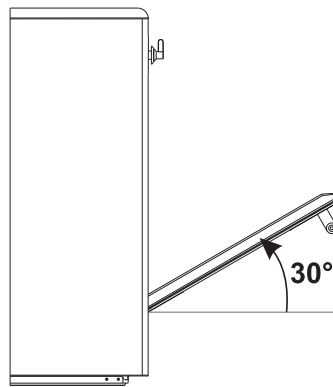

Grasp the door on both sides with both hands, lift it forming an angle of about 30° and remove it.

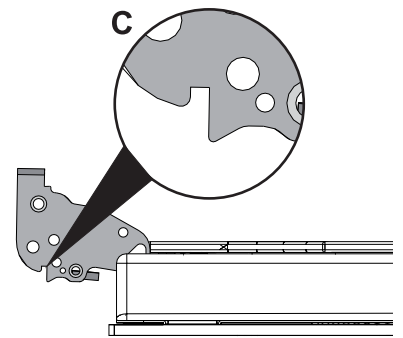

To reassemble the door, put the hinges in the relevant slots in the oven, making sure that grooved sections C are resting completely at the bottom of the slots. Lower the door and once it is in place remove the pins from the holes in the hinges.

9.2 Replacing the oven light bulb

Remove upper protection A and ring B as well as the glass cover C, twisting it counterclockwise. Replace light bulb D. Remount the ring B, cover C and upper protection A.

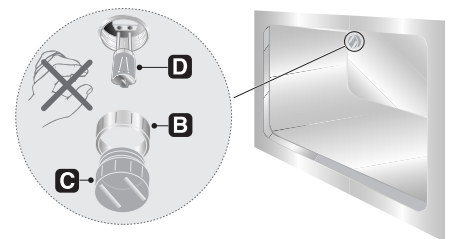

NOTE: Use only oven bulbs (T 600°F).



9.3 Removing the oven door gasket

To thoroughly clean the oven, the oven door gasket may be removed. Before removing the gasket, remove the oven door as described above. Lift the tabs at the corners as shown in the figure.

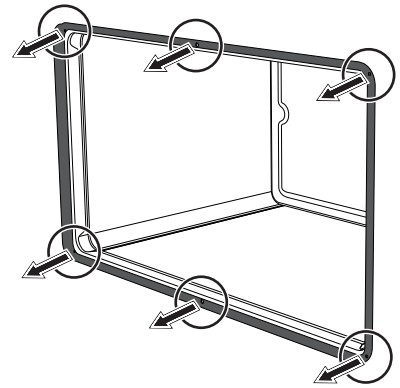

9.4 Lubricating the surface burner gas valves

Over time, the surface burner gas valves may become stiff or jam. Clean them internally and relubricate. This operation must be carried out by a qualified technician.

