

BUILT-IN SERIES

Creative Spirit, Performance & Quality



GOURMET GRILLS

napoleongrills.com



Appliance Authority
Your Appliance Authority™
800-570-3355



CREATIVE SPIRIT, PERFORMANCE & QUALITY



AjMadison
Your Appliance Authority
800-570-3355

A passionate dedication to grilling.

Napoleon®, a family owned Canadian company, has been providing home comfort for over 30 years, committed to designing and manufacturing only the finest high efficiency grills, fireplaces and outdoor living products you can depend on.... Proudly backed by the President's Limited Lifetime Warranty.

Superior technology, rock solid performance, balanced design and unparalleled customer service are the hallmark of the Napoleon® name. Your Napoleon® grill is designed to excel, offering a cooking experience as gratifying as the wonderful meals you'll create with it.

In the pages ahead, you'll discover the beauty and simplicity of Napoleon style the ideal complement to your patio environment.

Wishing many unforgettable meals grilled to perfection.

ARCHITECTURALLY DESIGNED



Prestige® V
BIPF600

AjMadison
Your Appliance Authority™
800-570-3355



FEATURES:

BIPF450 & BIPF600

- Up to 106,500 BTU's
- Total cooking area: up to 1,100 sq. in.
- Up to 7 burners
- Built-in halogen lights for nighttime grilling and entertaining
- Stainless steel smoker box adds a true smoked flavour to your meals
- Integrated dual side burners for fine cuisine cooking, for a total of 30,000 powerful BTU's
- Commercial quality rotisserie kit with counter balance, stainless steel bracket and four forks for delicious restaurant style cooking using the rear infrared burner
- Includes a heavy duty cover
- Cart models available

 **Proudly Made in Canada**



BIPF450

Doors and drawers are optional. Island not included.

ADVENTUROUS FREEDOM



Gemini™
Prestige® II
BIPT750RBI

INFRARED
SIZZLE
ZONE 

FEATURES:

BIPT750RBI

- Up to 92,500 BTU's
- Total cooking area: up to 1,160 sq. in.
- Total of 6 burners
- Commercial quality rotisserie kit with counter balance and four forks for delicious restaurant style cooking using the rear infrared burner
- Twin head cooking system
- Cart models available

 **Proudly Made in Canada**

Doors and drawers are optional. Island not included.

ENGINEERED EXCELLENCE



Prestige® Pro
BIPRO600RBI

AjMadison
Your Appliance Authority™
800-570-3355

**INFRARED
SIZZLE
ZONE**

FEATURES:

BIPRO600RBI

- Up to 82,500 BTU's
- Up to 922 sq. in. total cooking space
- Total of 5 burners
- Ceramic infrared bottom burner
- Deluxe high top, space saving LIFT EASE™ roll top lid with polished chrome trim accents and handle
- Commercial quality rotisserie kit with counter balance and 4 forks for delicious restaurant style cooking using the rear infrared burner
- Cart models available

 **Proudly Made in Canada**

Doors and drawers are optional. Island not included.

ATTENTION TO DETAIL



Prestige® Pro
BIPRO450RB

FEATURES:

BIPRO450RB

- Up to 62,000 BTU's
- Up to 695 sq. in. total cooking space
- Total of 4 burners
- Deluxe high top, space saving LIFT EASE™ roll top lid with polished chrome trim accents and handle
- Heavy duty rotisserie kit with counter balance and 2 forks for delicious restaurant style cooking using the rear infrared burner
- Cart models available

 **Proudly Made in Canada**

Doors and drawers are optional. Island not included.

VALUE PACKED



Ultra Chef®
BIU405RB

AjMadison
Your Appliance Authority™
800-570-3355

FEATURES:

BIU405RB

- Up to 59,000 BTU's
- Total Cooking Area: up to 570 sq. in.
- Total 4 burners
- Porcelainized cast iron WAVE™ reversible channel cooking grids
- Stainless steel infrared rear rotisserie burner
- Cart models available

 **Proudly Made in Canada**

Doors and drawers are optional. Island not included.

TECHNOLOGICAL INDULGENCE



Mirage™
BIM730RBI

800-570-3355

INFRARED
SIZZLE
ZONE

FEATURES:

BIM730RBI, BIM605RBI & BIM485RB

- Up to 107,000 BTU's
- Cooking Area: up to 1,025 sq. in.
- Up to 6 burners
- Unique, JETFIRE™ ignition system for easy start ups
- Engaging i-GLOW™ backlit control knobs for late night entertaining
- Optional commercial quality rotisserie kit with counter balance and two forks for delicious restaurant style cooking using the rear infrared burner. Flexible halogen light for night time cooking (BIM605RBI, BIM730RBI only)
- Cart models available

i-GLOW™
BACKLIT
TECHNOLOGY



BIM485RB



BIM605RBI



BIM730RBI

Doors and drawers are optional. Island not included.

OUTDOOR KITCHEN OASIS™



AjMadison
Your Appliance Authority™
800-570-3355

OASIS 200 shown with
BIM485RB Grill Head

FEATURES:

OASIS™ MODULAR ISLANDS

- Customize your own modular island components to suit your individual needs. There are four island configurations for reference (OASIS™ 400, 300, 200, 100)
- Powder coated galvanized steel
- Stainless steel doors and drawers for longevity
- Knock outs for easy electrical and gas piping installations
- Quick adjustment leveling feet on each modular unit
- Convenient cash and carry design
- Endless design possibilities
- Countertops not included



BIPRO450RB



BIPRO600RBI



BIPT750RBI



BIM485RB



BIM605RBI



BIM730RBI

OASIS™ MODULAR ISLAND CONFIGURATIONS



OASIS 300 shown with
BIPRO600RBI Grill Head



OASIS 100 shown with
BIM485RB Grill Head



OASIS 400 shown with
BIPT750RBI Grill Head

AIMadison
Your Appliance Authority™

800-570-3355

OASIS™ MODULAR ISLAND COMPONENTS



Under Grill Cabinets
Models: IM-UGC450
IM-UGC600
IM-UGC485
IM-UGC605
IM-UGC730



Under Grill Cabinets
Model: IM-UGC300
fits side burners
BISZ300
BISZ300FT
BISB245



Under Grill Cabinet
Model: IM-UGC750



Three Drawer Cabinet
Model: IM-3DC



Two Drawer Cabinet
Model: IM-2DC



Waste Drawer with
Paper Towel Holder
Model: IM-WDC



Propane or
Universal Cabinets
Models: IM-UTC (shown)
IM-UDC



Fridge Cabinet
Models: IM-FHR
IM-FHL
(includes Danby
2.5 cu.ft fridge)



Wall Spacer
Model: IM-WSF



Cabinet Transitions
Model: IM-45T = 45°



Cabinet End Panel
Model: IM-CEP



Ice Bucket Holder
Model: IM-IBA

BUILT-IN ISLAND DOORS & DRAWERS



Flat Vertical Stainless Steel Door
Model: N370-0071



Flat Horizontal Stainless Steel Door
Model: N370-0072



Deluxe Flat Stainless Steel Door Kit With Curved Stainless Steel Handle
Model: N370-0361



Flush Mount Stainless Steel Double Door
Model: N370-0502
N370-0503



Curved Stainless Steel Double Doors
Model: N370-0358SS



Curved Stainless Steel Door
Model: N370-0356SS



Curved Stainless Steel Door
Model: N370-0357SS



Deluxe Stainless Steel Triple Drawer With Curved Stainless Steel Handles
Model: N370-0360



Deluxe Stainless Steel Single Drawer With Curved Stainless Steel Handle
Model: N370-0359



Zero Clearance Kits
Models: BIZC450/600
Size: Fits any 450 or 600 models.
(excluding PF models)



13,500 BTU Drop-in Side Burner
Model: N370-0504(LP)
N370-0505 (NG)



ADDITIONAL BURNER ACCESSORIES



30,000 BTU Infrared SIZZLE ZONE™ Burner
Model: BISZ300 With LIFT EASE™ Roll Top Lid
BISZ300FT With Stainless Steel Flat Cover

Size: 465 sq. in. total cooking space - 300 sq. in. main



30,000 BTU Double Side Burner
Model: BISB245

Size: 245 sq. in. total cooking space

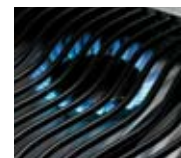

THE HEART OF A NAPOLEON® GRILL

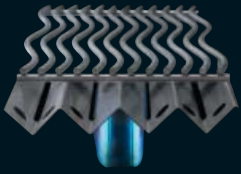

Heavy Duty Stainless Steel Cooking System

The even, consistent heat from high and hot to low and slow.

- Patented WAVE™ rod cooking grids for those Napoleon® trademark sear lines
- Patented self cleaning sear plates for reduced flare-ups
- Durable 16 gauge burners for controlled, even heat



Oven-like Performance

Napoleon's LIFT EASE™ roll top lid tucks neatly back giving you more space on your patio or deck. The tightly sealed lid will not be compromised by prevailing winds. Maximum heat is retained in the streamlined, double-walled lid for oven-like performance.



Versatile Burner Systems

- Rear stainless steel rotisserie burner heat waves seal and lock in the juices quickly for superior tenderness. Restaurant style results and perfect self-basting roasts every time. (Heavy duty rotisserie kit with counter balance, stainless steel rotisserie bracket and forks available with most models).
- Ceramic bottom burner with thousands of evenly spaced flame ports generate infrared radiant energy. The intense, 1800° heat of the infrared SIZZLE ZONE™ instantly locks in valuable juices, mouth-watering flavour, and tantalizing aroma, to deliver an amazing taste sensation. Go ahead, lift the lid, reach for the red knob.
- Tube burners run front to back for precise heat control, allowing for independent use of each cooking zone such as direct or indirect cooking.



Charcoal Flavour From Your Gas Grill

Napoleon's optional charcoal tray is designed to let you add the fun & flavour of charcoal anytime, on your gas grill. Simply replace a sear plate with the charcoal tray, add charcoal and light with your gas grill.

Electronic Ignition

Simple one touch electronic ignition ensures trouble free starts.



Universal Rotisserie Kit

Every Napoleon® Prestige® grill (excluding P450) comes with a complete rotisserie kit to use with your rear burner. The rotisserie kit allows you to cook larger roasts, chickens and turkeys using the restaurant style method of rotating the meat while cooking from the rear burner, self basting in it's own juices.



Temperature Gauge

The ACCU-PROBE™ temperature gauge lets you safely and instantly read the internal temperature of your grill with the lid closed. It works like your conventional oven and features a heat-resistant stainless steel probe. This thermometer has a wide temperature measurement range from 0° to 370°C (0° to 700°F) and includes the ideal smoking and searing range.



Napoleon® Limited Lifetime Warranty

A growing number of people are discovering the joys of cooking on their Napoleon® grill. We are here to ensure your love for your Napoleon® grill is a bond that continues to bring you and your family a sensational grilling experience for years to come. Your purchase includes exclusive access to our customer care hotline and President's Limited Lifetime warranty, providing you with peace of mind.

THE MOST VERSATILE COOKING STYLES AVAILABLE

Direct Cooking

This method of cooking utilizes all burners, cooking the food directly above the flame “GRILLING” style, for searing steaks, other meats or vegetables. Keeping the lid down reduces the cooking time and cooks through to the center faster than with the lid up. Anything that is less than 2 inches in thickness should be cooked by direct grilling. These are things that generally cook quickly and benefit from the fast cooking of a hot grill. Front to back burners were designed for precise heat control, allowing for independent use of each cooking zone.



Indirect Cooking

Indirect grilling is similar to baking. The food is placed above the unlit burner instead of directly over the flame. This can be achieved by only igniting some of the burners – light one side on high and cook the food on the other. The food will cook more evenly as it is not exposed to direct heat from the burners. This is an excellent way to cook tough cuts of meat, like brisket and ribs, that require long, slow cooking at a low or moderate heat. Indirect grilling allows you to work over a more moderate temperature (275° to 350°) and makes it easy to introduce a smoker pipe for extra flavour. For chicken, game, turkey, roasts, ham, vegetables, bread or combinations, the indirect cooking method gives great results every time. There is little need to turn the food. You can place the food directly on the grids or in a cooking pan.



Rotisserie Cooking

Rotisserie cooking allows the food to self-baste, sealing in the juices while browning the outside surface. Use the rotisserie method of cooking for large cuts of meat like roasts, poultry or legs of lamb. There are so many advantages to rotisserie cooking. Meats are generally juicier, self-basted and slow roasted. You can use the rotisserie method if your grill comes with a rear rotisserie burner, which requires much less attention than any other cooking method. The rotisserie burner is a nice feature because it automatically sets you up for direct, even heating.



Infrared Bottom Burner Cooking

Do you want to make the perfect steak? The intense 1800° heat instantly sears the meat, locking in the juices. Larger cuts of meat may be moved to the side of the grill to continue cooking.

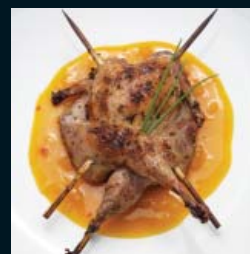

Convection Style Cooking

Bread, buns, cakes and pizzas can be cooked to perfection under the grill hood. For convection cooking, follow the same instructions as for the indirect cooking method. Your grill comes with a tightly sealed lid for heat retention, giving oven-like performance.

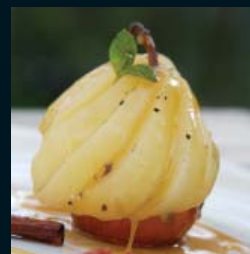

Smoking

Place wet wood chips into the smoker tube and place over the left burner, then turn the burner on. Place your meat over the right burner, but do not turn on that burner. You are using the indirect cooking method. Smoke the meat for several hours under a closed lid. To achieve maximum flavour, fresh wood chips may be added several times during the cooking process.



Charcoal Cooking

Unique to Napoleon®! Optional charcoal trays. Gives you the freedom to switch from gas to charcoal with relative ease. With charcoal you can utilize indirect cooking as well as direct cooking.

THE ANATOMY OF THE PERFECT OUTDOOR KITCHEN

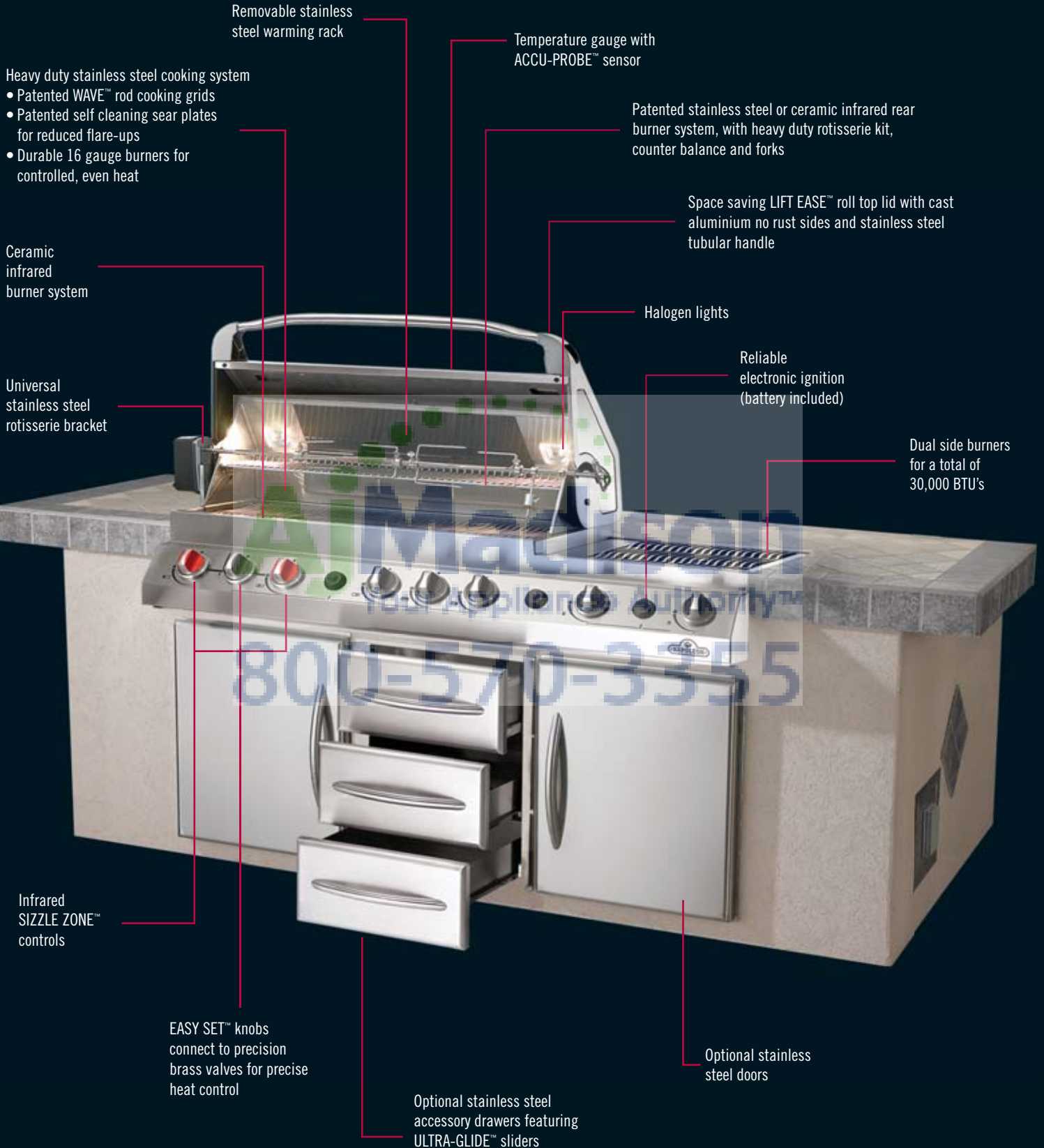

800-570-3355

INSTALLATION SPECIFICATIONS

OASIS™ MODULAR ISLAND SAMPLE

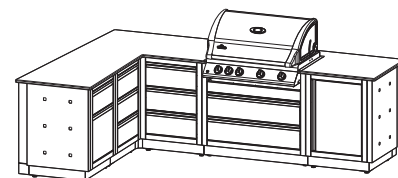
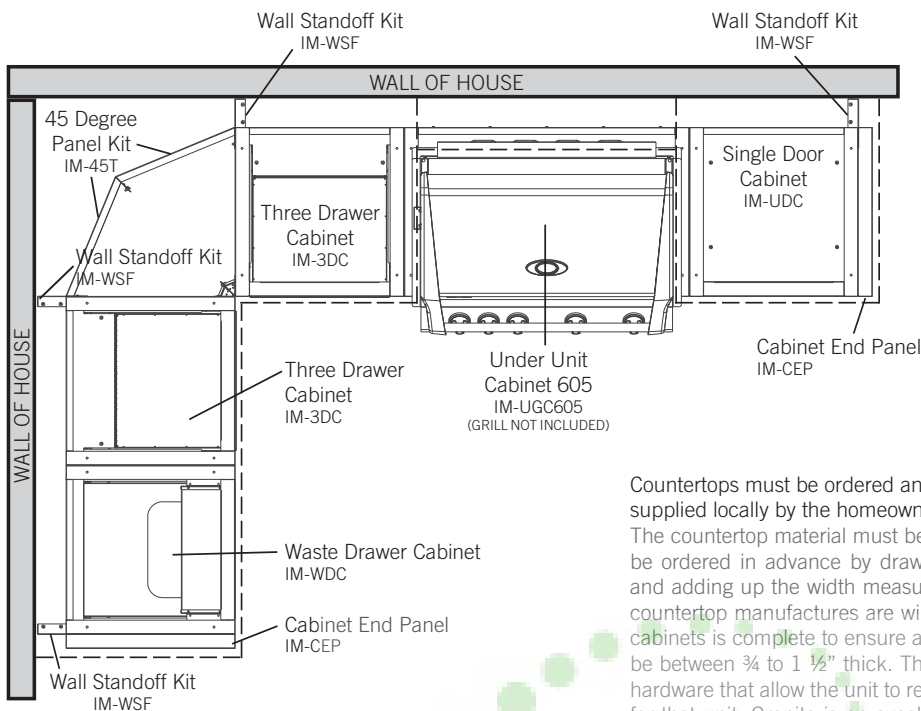

Countertops must be ordered and supplied locally by the homeowner.

The countertop material must be non-combustible if a grill is to be installed into it. They can be ordered in advance by drawing out the floor plan of how the cabinets will be situated and adding up the width measurements, allowing 1-2 inches of countertop overhang. Most countertop manufacturers are willing to come and take measurements after assembly of the cabinets is complete to ensure a perfect fit. For best results the countertop thickness should be between 3/4 to 1 1/2" thick. The built-in grill head comes with stainless steel brackets and hardware that allow the unit to rest on the countertop above the corresponding island cabinet for that unit. Granite is an excellent choice of countertop materials. Decorative countertops made of ceramic tile set on top of cement tiling board can be selected to match your surrounding backyard furniture colour.

BUILT-IN SAMPLE

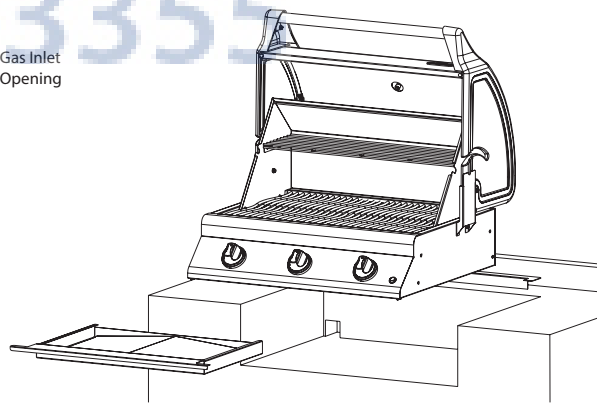
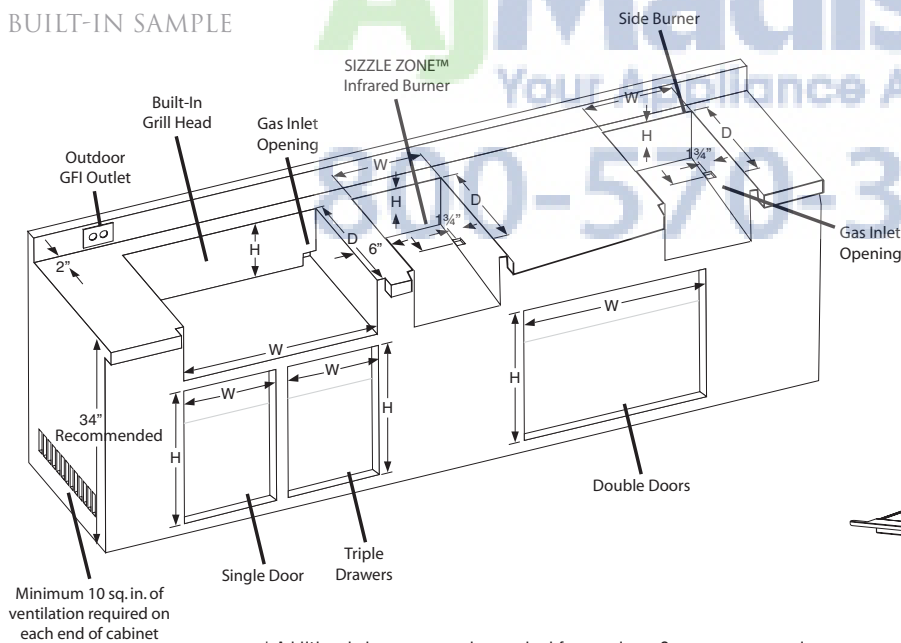

* Additional clearance may be required for openings. See owners manual

Please use manual to properly assemble your built-in grill. Refer to the main manual for operating, cleaning, and maintenance instructions. This grill is designed for non-combustible enclosures only (unless the Napoleon® zero clearance kit is utilized), and must be installed and serviced by a qualified installer to local codes.

BUILT-IN PROPANE GAS HOOK-UP: The piping up to the gas grill is the responsibility of the installer and piping should be located as shown in the built-in instructions. The installation must comply with CAN B149.1 Natural Gas and Propane installation code in Canada, or to the National Fuel Gas code, ANSI Z223.1 in the United States. The tank can not be stored below the gas grill. Built-in units are supplied with a drip pan which holds only a minimal amount of grease. To prevent grease fires, the pan must be cleaned after each use.

Drawings for reference only. Minimum 6" clearance required between grill and other appliance. Specifications subject to change without notice.

SPECIFICATIONS	BIPF600	BIPF450	BIPT750RBI	BIPRO600RBI	BIPRO450RB	BIM730RBI	BIM605RBI	BIM485RB	BIU405RB
LIFT EASE™ roll top lid	S	S	S	S	S	S	S	S	S
ACCU PROBE™ temperature gauge	S	S	S	S	S	S	S	S	S
Total cooking surface (sq. in.)*	1100	890	1160	922	695	1025	850	675	570
Electronic ignition	S	S	S	S	S	S	S	S	S
Rear burner igniter	S	S	S	S	S	S	S	S	-
Infrared ceramic bottom burners	2	1	2	-	-	1	1	-	-
Stainless steel bottom burners	2	2	3	4	3	4	3	3	3
Infrared rear rotisserie burner	S	S	S	S	S	S	S	-	-
Stainless steel WAVE™ rod cooking grids	-	-	-	-	-	S	S	S	-
Stainless steel WAVE™ 3/8" rod cooking grids	S	S	S	S	S	-	-	-	-
Porcelain cast iron WAVE™ reversible channel cooking grids	-	-	-	-	-	-	-	-	S
iGlow™ knobs	-	-	-	-	-	S	S	S	-
EASY SET™ knobs	S	S	S	S	S	-	-	-	S
Rotisserie and forks	4	4	4	2	2	2	2	-	0
Rotisserie with flexible halogen light	-	-	-	-	-	S	S	S	-
Removable drip pan	S	S	S	S	S	S	S	S	S
Warming rack	S	S	S	S	S	S	S	S	S
President's Limited Lifetime Warranty	S	S	S	S	S	S	S	S	-

DIMENSIONS (OPENING SIZE)	BIPF600	BIPF450	BIPT750RBI	BIPRO600RBI	BIPRO450RB	BIM730RBI	BIM605RBI	BIM485RB	BIU405RB
Width (in)	55 3/4"	46 3/4"	49 3/4"	37 3/4"	29 1/2"	43 1/4"	36 1/2"	29 3/4"	27 1/2"
Height (in)	8 7/8"	8 7/8"	9 5/8"	8 7/8"	8 7/8"	7 1/2"	7 1/2"	7 1/2"	12"
Depth (in)	20 5/8"	20 5/8"	20 5/8"	20 5/8"	20 5/8"	21 3/8"	21 3/8"	21 3/8"	16 3/4"

S = Standard 0 = Optional * All lid openings require a minimum of 2" clearance behind the unit, except the Ultra Chef series. Ultra Chef requires 3" clearance. Refer to owners manual for individual models. - Dimensions subject to change. Refer to manual for accurate dimensions

OPENING DIMENSIONS

DIMENSIONS

DOORS & ACCESSORIES	Part Number	Width	Height	Depth	OASIS MODULAR COMPONENTS	Part Number	Width	Height	Depth
Flat Vertical Stainless Steel Door	N370-0071	13 1/4"	18 1/4"	-	Under Grill Cabinet - 300 series	IM-UGC300	24"	35"	24"
Flat Horizontal Stainless Steel Door	N370-0072	18 1/4"	13 1/4"	-	Under Grill Cabinet - 450 series	IM-UGC450	33 3/4"	35"	24"
Curved Stainless Steel Door	N370-0356SS	22 1/2"	19 3/4"	-	Under Grill Cabinet - 600 series	IM-UGC600	42"	35"	24"
Curved Stainless Steel Door	N370-0357SS	27"	19 3/4"	-	Under Grill Cabinet - 750 series	IM-UGC750	53 3/4"	35"	24"
Curved Stainless Steel Double Door	N370-0358SS	35 1/4"	19"	-	Under Grill Cabinet - 485 series	IM-UGC485	33 3/4"	35"	24"
Flat Stainless Steel Door	N370-0361	17"	23 1/4"	-	Under Grill Cabinet - 605 series	IM-UGC605	40 1/2"	35"	24"
Flushed Mount Stainless Steel Double Door	N370-0502	28 1/4"	20 1/4"	-	Under Grill Cabinet - 730 series	IM-UGC730	47 1/4"	35"	24"
Flushed Mount Stainless Steel Double Door	N370-0503	37 3/4"	20 1/4"	-	Propane Tank Cabinet - universal door	IM-UTC	24"	35"	24"
Stainless Steel Single Drawer	N370-0359	17 1/4"	6 3/4"	23"	Universal Door Cabinet	IM-UDC	24"	35"	24"
Stainless Steel Triple Drawer	N370-0360	17 1/4"	22 3/4"	23"	Fridge Cabinet	IM-FDC	24"	35"	24"
Infrared SIZZLE ZONE™ Burner With Roll Top	BISZ300	20 1/8"	9 5/8"	20 5/8"	Three Drawer Cabinet	IM-3DC	24"	35"	24"
Infrared SIZZLE ZONE™ With Flat Top	BISZ300FT	20 1/8"	9 5/8"	20 5/8"	Two Drawer Cabinet	IM-2DC	24"	35"	24"
Double Side Burner	BISB200	20 1/8"	8 7/8"	20 5/8"	Waste Drawer with Paper Towel Holder	IM-WDC	24"	35"	24"
Side Burner	N370-0504/05	18"	15"	4 1/2"	Cabinet End Panel	IM-CEP	24"	31"	2"
Zero Clearance (1) 29"	BIZC450	35 7/8"	22 15/16"	11 1/8"	Cabinet Transitions - 45 degrees	IM-45T	18 3/8"	35"	-
Zero Clearance (2) 37"	BIZC600	44 1/8"	22 15/16"	11 1/8"	Wall Spacer	IM-WSF	4"	35"	1 1/2"
					Ice Bucket Holder	IM-IBA	19 1/8"	1 3/16"	16"

PRESTIGE V SERIES



BIPF600 BIPF450

PRESTIGE II SERIES



BIPT750RBI

MIRAGE SERIES



BIM730RBI BIM605RBI BIM485RB

ULTRA CHEF SERIES



BIU405RB

PRESTIGE PRO SERIES



BIPRO600RBI BIPRO450RB

OASIS SERIES*



OASIS 100 OASIS 200 OASIS 300 OASIS 400

* Example Configurations Only

A PASSIONATE DEDICATION TO GRILLING



Electric Fireplaces



BBQ Accessories



Gas Fireplaces

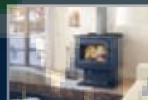

Wood Stoves



Waterfalls



Casual Furniture



Patioflame®



Outdoor Gas Fireplaces



Approved by Intertek Testing Services to standards in the USA and Canada: ANSI Z21.58/CSA 1995 CSA-1.6 - Outdoor Cooking Gas Appliances. All specifications and designs are subject to change without prior notice due to ongoing product improvements. Consult your owner's manual for complete installation and operating instructions and check all local and national Building Codes and Regulations. Not all features available on all models. Napoleon® is a registered trademark of Wolf Steel Ltd. Patent U.S.S. 676,048-5,617, 778, DES433875, 417497, Patents Pending. The red knob design is a trademark of NAC. Images and colors may not be exactly as shown.



- 214 Bayview Drive, Barrie, Ontario, Canada L4N 4Y8
- 103 Miller Drive, Crittenden, Kentucky, USA 41030
- 7200 Trans Canada Highway, Montreal, Quebec H4T 1A3

PHONE: 705-726-4278 • FAX: 705-725-2564
 napoleongrills.com
 info@napoleonproducts.com

Authorized Dealer



Printed in Canada
 ADBRB1 09/2010

