



A man in a dark sweater and jeans is sitting on a window seat, reading a newspaper and holding a mug. The window seat has a large, textured pillow. The wall below the window is wood-paneled, and a white Broan heater is mounted on the wall. The scene is lit with warm, natural light from the window.

Broan Heaters. Put the comfort you want right where it's needed.

Why spot heating makes sense in your home.

Think about it—you hastily get ready every morning, head for work, the office, or school, just when the central heating system has finished warming the entire house. It's about as inefficient as it gets. Spot heating solves that problem. No longer will you heat an entire home when you simply need a bit of comfort in the bath or dressing room, or any other room.

Efficient Heating Element.

Even the most efficient central heating systems send heat up the chimney. But NuTone spot heaters deliver every bit of energy back into your home. There's no

external venting, so the electricity you convert to heat is delivered directly where you want it.

Simple, Safe and Efficient.

Permanently lubricated motors are quiet and require no maintenance. They can be operated by a built-in adjustable thermostat or an optional wall-mount controller. Heaters may be converted in the field to a choice of wattages/voltages. And for safety, heaters are thermal overload protected and the complete heater assembly conveniently removes from the housing for cleaning.



Broan Heaters—Wall Heaters

High capacity wall heaters for residential and light commercial use. When you need more power for high heat-loss areas, Broan's large capacity wall heaters are an ideal solution for lobbies, entrance ways, vestibules or any area requiring high wattage heating. Our low-profile models feature an energy-saving, built-in fan-delay switch allowing the heating element to warm up before the fan starts. To ensure proper shutdown, and maximize heat delivery, the fan remains on as the element cools down.



Models 9810WH & 9815WH

- Quiet fan and downflow action circulates heated air quickly.
- Dual-voltage 120V/240V (see chart for watts)
- Over temperature protected by thermal fuse
- Built-in adjustable thermostat. Quiet thermally-protected motor and transverse flow blower
- White polymeric heat-resistant grille

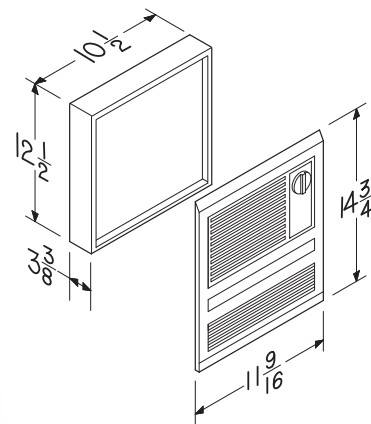



Models 192, 194 & 198

Steel-sheathed, plate-finned, heavy-duty enclosed heating element.

- Adjustable, built-in, heavy-duty, disc-type thermostat
- Manual reset overload protection
- Internal fan delay prevents cold air delivery

Model 192

- Factory wired for 2000W at 240V AC—easily converts to half-wattage

Model 194

- Factory wired for 3000W at 240V AC—easily converts to half-wattage

Model 198

- Factory wired for 4000W at 240V AC—easily converts to half-wattage

Model*	Watts	Volts	Amps
192	750W–1500W	208	3.61/7.21
	1000W–2000W	240	4.17/8.33
194	1125W–2250W	208	5.41/10.82
	1500W–3000W	240	6.25/12.5
198	1500W–3000W	208	7.21/14.42
	2000W–4000W	240	8.33/16.67
9810WH	1000	120/240	9.0/4.5
9815WH	1500	120/240	13.0/6.5

*To be used to supply supplemental heat.

Surface Mounting Kit

Model 85

- Includes all hardware for surface mounting of Broan High-Capacity heaters
- Color coordinated to match heater grille
- Heavy-duty 22-gauge steel
- Measures 17-3/4"W x 21-5/8"H x 3-3/4"D
- Not for use with models 9810WH and 9815WH

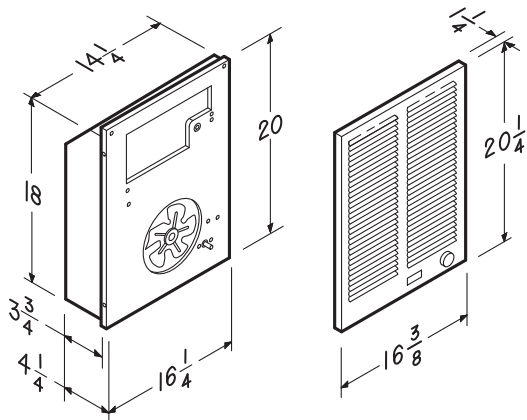

Broan Heaters—Wall Heaters

Heat that's ready when you're ready. These versatile heaters are factory wired at 500W, 750W, 1000W, 1500W or 2000W, and can be easily converted to other wattages and voltages. Count on Broan Comfort-Flo Heaters to deliver precisely what you need for your home.



Wall Heater Features

- Sturdy 24-gauge steel housing mounts easily between studs in any standard wall
- Surface mounted where needed
- Housing mask prevents construction damage to roughed-in units
- Snap-out wiring cover for wiring away from tight corners
- Project Packs available (see below and page 11)

Model 170

- Factory wired for 1000W at 120V AC—easily converts to 500W at 120V AC or 1000W at 240V AC

Model 174

- Factory wired for 1500W at 120V AC—easily converts to 750W at 120V AC or 1500W at 240V AC

Model 178

- Factory wired for 2000W at 240V AC—easily converts to 1000W at 240V AC

Surface Mounting Kit

Model 84

- Includes all hardware for surface mounting of Broan Comfort-Flo heaters
- White enameled, steel enclosure matches grille color
- 12-3/8"W x 9-5/8"H x 3-7/8"D

Model*	Watts	Volts	Amps
170	500W–1000W	120	4.16/8.33
	750W	208	3.61
	1000W	240	4.16
174	750W–1500W	120	6.25/12.5
	1125W	208	5.41
	1500W	240	6.25
178	750W–1500W	208	3.61/7.21
	1000W–2000W	240	4.16/8.33

*To be used to supply supplemental heat.

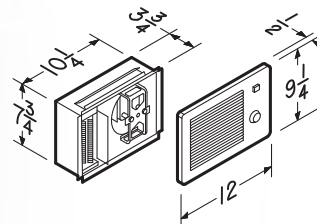

Project Packs keep you on schedule:

Broan Comfort-Flo Heaters are available in project packs so you can install the housing now and decide which finish kit is best suited for your project later. Housing Units (the shell that holds the heater) come in packages of four. Finish kits (the heating element and grille) contain only one product. The selection matrix on page 11 has more details to help you select the right Project Pack for your installation.



Register Heaters. These powerful heaters are factory wired at 1000W, 1500W and 2000W and can be easily converted to half-wattage for added versatility. The low-wall mounting and register-look grille in a neutral white finish make them as inconspicuous as they are efficient.

Model 120

- Factory wired for 1000W at 120V AC—easily converts to 500W at 120V, or 1000W at 240V AC

Model 124

- Factory wired for 1500W at 120V AC—easily converts to 750W at 120V, or 1500W at 240V AC

Model 128

- Factory wired for 2000W at 240V AC—easily converts to 1000W at 240V AC



Model*	Watts	Volts	Amps
	500-1000	120	4.16/8.33
120	750	208	3.61
	1000	240	4.16
	750-1500	120	6.25/12.5
124	1125	208	5.41
	1500	240	6.25
128	750-1500	208	3.61/7.21
	1000-2000	240	4.16/8.33

*To be used to supply supplemental heat.

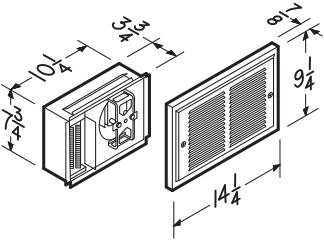

Line-Voltage Wall Thermostat

Model 86W

- Required for use with models 120, 124 and 128
- Single-pole, 120V/240V AC, 22 amps
- 50° to 85° temperature range
- Snap-action, bimetallic sensing strip



Broan Heaters—Kickspace and Ceiling

Trimline Kickspace Heaters. If you don't believe you have room for auxiliary heat, you haven't seen Trimline kickspace heaters. They tuck under cabinet kickspaces, vanity bases, stairways or any place where space is limited. Consider them for light-commercial applications such as ticket/toll booths and checkout counters where ducting isn't possible.

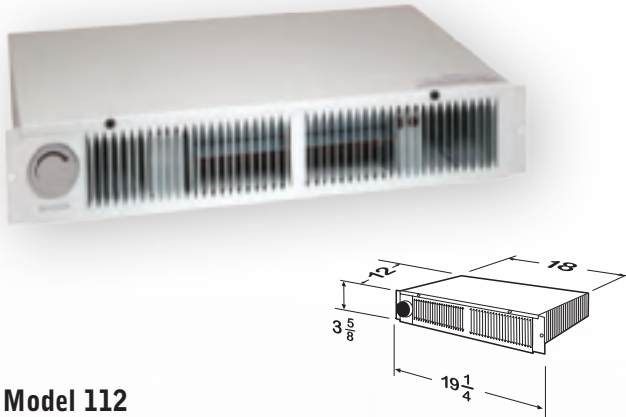

Model 112

- With built-in thermostat
- Steel-sheathed, plate-finned, heavy-duty heating element
- Factory wired 1500W at 240V AC, converts to 750W or 1500W at 120V

Model 114

- Same as 112 without built-in thermostat
- Steel-sheathed, plate-finned, heavy-duty heating element
- Factory wired 1500W at 240V AC, converts to 750W or 1500W at 120V
- Use Model 90 accessory built-in thermostat if desired

Model*	Watts	Volts	Amps
	750	120	6.3
112 and 114	1125	208	5.4
	1500	120	12.5
	1500	240	6.3

*To be used to supply supplemental heat.

Ceiling Heaters. Fan-forced or infrared bulb heat, and convenient combinations. The reliable design and quality construction is all Broan. Either way, you get energy-saving warmth in compact, easy-to-install units.

Surface-mount Fan Forced Air Model 154 & 157



Wire Element Heater—Model 154

- Chrome alloy, wire element for instant heat
- Low-profile housing with satin-finish aluminum grille extends only 2-3/4" from ceiling
- Built-in fan disperses heat evenly
- Automatic overheat protection
- Permanently lubricated motor
- Mounts easily to any standard 3-1/2" or 4" round, or 4" octagonal ceiling electrical box

Radiant Heater—Model 157

- Exclusive enclosed, sheathed, long-life element diffuses heat throughout the room
- Low-profile housing with satin-finish aluminum grille extends only 2-3/4" from ceiling
- Built-in fan disperses heat evenly
- Automatic overheat protection
- Permanently lubricated motor
- Mounts easily to any standard 3-1/2" or 4" round, or 4" octagonal ceiling electrical box

Model	Watts	Volts	Amps
154	1250	120	10.7
157	1250	120	10.7

Bulb Heater Fans. Silent warmth and superior ventilation. Trust Broan Bulb Heater/Fans and Bulb Heaters for energy-saving warmth and instant comfort without ever having to touch your central thermostat. These units deliver superior performance and excellent ventilation in a compact package.

Bulb Heater/Fan Features

- Quiet, highly efficient polymeric blower wheels
- Polymeric dampers prevent backdrafts and eliminate mechanical noise
- Polymeric 4" round duct connectors with tapered sleeves simplify ducting
- Operate fan and heater independently or together
- Attractive, white polymeric grilles
- Compact steel housings feature adjustable mounting brackets with keyhole slots that span up to 24"
- 250-watt R40 or BR40 size infrared bulbs (not included)
- Type IC, UL Listed for 60°C wiring (retrofits)

Model 162

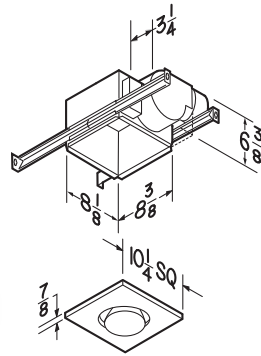
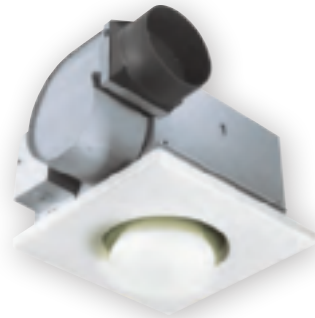

- One-Bulb Heater/Fan

Model 164

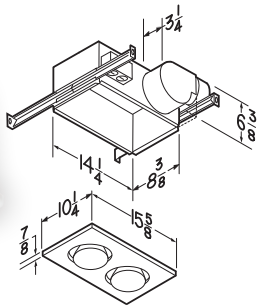

- Two-Bulb Heater/Fan
- Two-function control (available separately)

Model	CFM	Sones	Watts	Volts	Amps
162	70	3.5	250*	120	2.5
164	70	3.5	500*	120	4.5

*Infrared bulbs not included

Bulb Heaters Only

- Infrared bulbs deliver energy-saving warmth
- Get instant comfort in the bathroom without turning up the central thermostat
- 250-watt R40/BR40 size infrared bulbs (not included)
- Attractive, white polymeric grilles
- Compact steel housings
- Adjustable mounting brackets with keyhole slots span up to 24"

Model 161

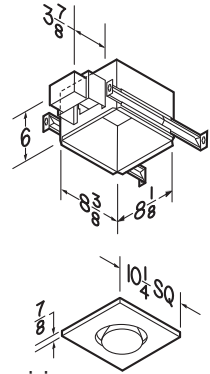
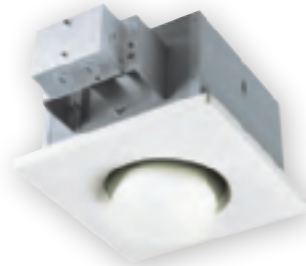

- One-Bulb Heater
- Non-type IC, use 75°C minimum house wiring

Model 163

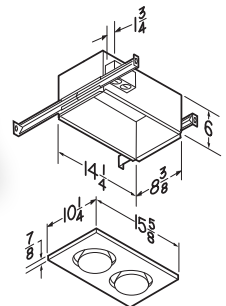

- Two-Bulb Heater
- IC rated

Model	Watts	Volts	Amps
161*	250**	120	2.1
163	500**	120	4.3

*161 is not IC rated

**Infrared bulbs not included

Broan Heater—Portable

Why Broan Big Heat®? Because this rugged, reliable heater works as hard as you do. Our portable, electric heater is the perfect solution to instant heat, with a full 1500 watts and a reliable, ceramic heating element to ensure fast warm-up. It will keep you comfortable in nearly any situation—the garage, workshop or on the job. Rugged steel construction, automatic shut-off if tipped over on its front or back, and overheat protection mean that Broan Big Heat is not only durable, but safe. No matter where you put it to work, it's just what you need, right when you need it.



Broan Big Heat® Portable Heater



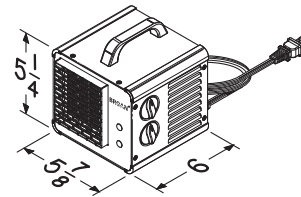

Model 6201

- Rugged steel construction, durable finish with integrated carrying handle and rounded bumpers to protect surfaces
- Instant, automatic safety shut-off if tipped over on its front or back
- Overheat protection shuts off the heater and activates the "caution" light if excess heat is detected
- Efficient, ceramic heating elements with full 1500 watts for fast warm-up, 1200 watt setting maintains warmth using less electricity
- High, low, or fan only settings with quiet operation
- Built-in thermostat to hold the comfort level you select
- 6' cord with safety flanged plug

Model	Watts	Volts	Amps
6201	1200–1500	120	10.0/12.5



Broan Heater Accessories

Accessory Number	Product	For Heater Models	Description
 82	Low Voltage Transformer/Relay	192, 194, 198	Mounts inside and allows control of line voltage in Broan High Capacity Heaters.
83	Thermostat Kit	165F, 167F, 170F, 174F, 178F	Built-in thermostat kit for Wall Heaters.
 84	Surface Mount Kit	165F, 165FT, 167F, 167FT, 170, 170F, 170FT, 174, 174F, 174FT, 178, 178F, 178FT	White enameled steel housing for surface mounting a wall heater.
 85	Surface Mount Kit	192, 194, 198	White enameled steel housing for surface mounting a high capacity wall heater.
 86W	Line Voltage Wall Thermostat	Snap action, bi-metallic single pole rated thermostat for all heater products.	50°–85° rotary thermostat, white finish.
90	Thermostat Kit	114	Built-in thermostat kit for kickspace heaters. Temperature range 40°–130°

F and FT models are factory wired at 500–750 Watts.

Broan Heaters—Wall Control

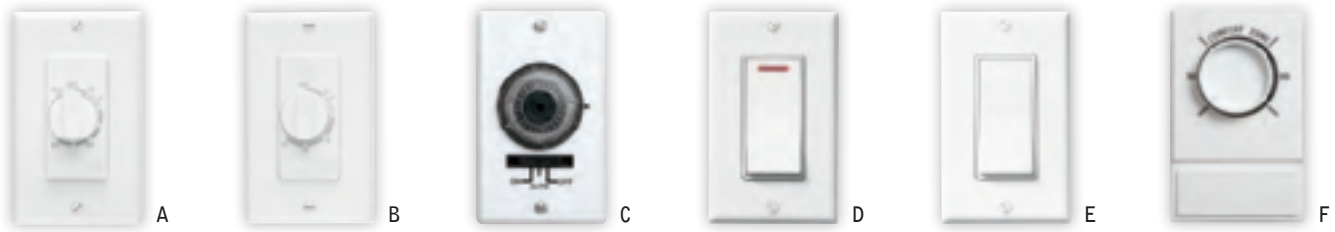

A. Model 59W, 59V

- Timer control up to 60 minutes
- Fits single-gang box
- 120V, 20 amps; 240V, 10 amps
- Blister packs available
- Operate continuously or for any set period

B. Model 61W, 61V

- Timer control up to 15 minutes
- Fits single-gang box
- 120V, 20 amps; 240V, 10 amps
- Blister packs available
- Operate for any set period up to 15 minutes (no “continuous on” position)

C. Model T24H

- 24-Hour programmable timer
- 120V, 8 amps inductive load
- Sets up to 36 on/off cycles as short as 20 minutes
- Manual on/off override switch
- Fits single-gang box

D. Model 69WL, 69VL

- Single-Function Control with indicator light
- Red light indicates power is on
- For use with Ultra Silent™ Series fan units, or Remote In-Line Ventilators
- 120V, 20 amps
- Blister packs (P69WL, P69VL)

E. Model 69W, 69V

- Single-Function Control
- 120V, 15 amps

F. Model 86W

- For use with heater models 120, 124 and 128 (see page 7)
- Single-pole, 120V/240VAC, 22 amps
- 50° to 85° temperature range
- Snap-action, bimetallic sensing strip

Heaters

	Heater				Housing Dimensions			Grille Dimensions		Grille Finish	Project Packs	
	Wattage	Volts	Amps	BTU/hr	W"	H"	D"	W"	H"		Housing	Finish Kit
112	750	120	6.3	2560	18	3%	12	19%	3%	White Baked Enamel		
	1125	208	5.4	3840	18	3%	12	19%	3%			
114	1500	120	12.5	5120	18	3%	12	19%	3%	White Baked Enamel		
	1500	240	6.3	5120	18	3%	12	19%	3%			
120	500/1000	120	4.16/8.33	1707/3413	10%	7%	3%	14%	9%	White Baked Enamel		
	750	208	3.61	2560	10%	7%	3%	14%	9%			
	1000	240	4.16	3413	10%	7%	3%	14%	9%			
124	750/1500	120	6.25/12.5	2560/5120	10%	7%	3%	14%	9%	White Baked Enamel		
	1125	208	5.41	3840	10%	7%	3%	14%	9%			
	1500	240	6.25	5120	10%	7%	3%	14%	9%			
128	750/1500	208	3.61/7.21	2560/5120	10%	7%	3%	14%	9%	White Baked Enamel		
	1000/2000	240	4.16/8.33	3413/6827	10%	7%	3%	14%	9%			
154	1250	120	10.7	4266	11 Dia	2%	—	—	—	Satin Aluminum		
157	1250	120	10.7	4266	11 Dia	2%	—	—	—	Satin Aluminum		
170	500/1000	120	4.16/8.33	1707/3413	10%	7%	3%	12	9%	White Baked Enamel	171H	165F*, 165FT**, 167F*, 167FT**, 170F*, 170FT**
	750	208	3.61	2560	10%	7%	3%	12	9%			
	1000	240	4.16	3413	10%	7%	3%	12	9%			
174	750/1500	120	6.25/12.5	2560/5120	10%	7%	3%	12	9%	White Baked Enamel	171H	165F*, 165FT**, 167F*, 167FT**, 174F*, 174FT**
	1125	208	5.41	3840	10%	7%	3%	12	9%			
	1500	240	6.25	5120	10%	7%	3%	12	9%			
178	750/1500	208	3.61/7.21	2560/5120	10%	7%	3%	12	9%	White Baked Enamel	171H	165F*, 165FT**, 167F*, 167FT**, 178F*, 178FT**
	1000/2000	240	4.16/8.33	3413/6827	10%	7%	3%	12	9%			
192	750/1500	208	3.61/7.21	2560/5120	14%	20	4%	16%	20%	White Baked Enamel		
	1000/2000	240	4.17/8.33	3413/6827	14%	20	4%	16%	20%			
194	1125/2250	208	5.41/10.82	3840/7677	14%	20	4%	16%	20%	White Baked Enamel		
	1500/3000	240	6.25/12.5	5120/10236	14%	20	4%	16%	20%			
198	1500/3000	208	7.21/14.42	5120/10240	14%	20	4%	16%	20%	White Baked Enamel		
	2000/4000	240	8.33/16.67	6827/13653	14%	20	4%	16%	20%			
6201	1200/1500	120	10.0/12.5	4095/5120	5%	5%	6	3%	3%	Grey Baked Enamel		
9810WH	1000	120/240	9.0/4.5	3413	10½	12½	3%	11½	14¾	White Polymeric		
9815WH	1500	120/240	13.0/6.5	5120	10½	12½	3%	11½	14¾	White Polymeric		

Project Packs. To reduce jobsite damage, Broan Heaters can be ordered in project packs which feature housings packed separately from the finish kit. Install the housing and when drywall and painting is complete, add the heating element and grille.

*Use Project Pack Model Number 83 Thermostat Kit with these models. **Includes built-in thermostat.

F and FT models are factory wired at 500–750 Watts.

Broan. The leader in residential ventilation.



Broan® is America's leading brand of residential ventilation products including range hoods, ventilation fans, heater/fan/light combination units, Indoor Air Quality (IAQ) Systems, built-in heaters, whole-house fans, attic ventilators and trash compactors.

NuTone® is America's leading brand of residential built-in convenience products including door chimes, central vacuum systems, intercom systems, ceiling fans, home theater speakers, medicine cabinets, ironing centers and ventilation fans.

BROAN®

www.Broan.com

Broan-NuTone LLC, 926 W. State Street, Hartford, WI 53027 • **800-558-1711**
In Canada call **877-896-1119**



0 26715 18248 0