



BOSCH

Register your
appliance and join
the Bosch
family of perks:
[bosch-home.com/us/
mybosch](https://bosch-home.com/us/mybosch)



Washing machine

WGA1440UC

[en-us] User manual and installation
instructions

Further information and explanations are available online:



Table of contents

1 Safety	3	13.5 Inserting the measuring aid	23
1.1 Safety definitions.....	3	13.6 Using the measuring aid.....	23
1.2 General information.....	3	13.7 Adding detergent and care product	24
1.3 Intended use	3	13.8 Starting the program.....	24
1.4 Restrictive Use.....	3	13.9 Soaking laundry	24
1.5 Grounding instructions	3	13.10 Adding laundry	24
1.6 Safe installation.....	4	13.11 Terminating the program	24
1.7 Safe use.....	4	13.12 Removing the laundry	24
1.8 Safe cleaning and maintenance	5	13.13 Switching off the appliance.....	24
1.9 State of California Proposition 65 Warnings	6	14 Control panel lock	24
2 Preventing material damage	7	14.1 Activating the control panel lock	24
3 Environmental protection and energy-saving	7	14.2 Deactivating the control panel lock.....	25
3.1 Disposal of packaging	7	15 Basic settings	25
3.2 Save energy and conserve resources	7	15.1 Overview of the basic settings.....	25
3.3 Energy-saving mode	7	15.2 Changing the basic settings	25
4 Installation and connection	7	16 Cleaning and maintenance	25
4.1 Unpacking the appliance	7	16.1 Cleaning the drum	25
4.2 Included in delivery	8	16.2 Cleaning the detergent drawer	25
4.3 Requirements for the installation location.....	8	16.3 Cleaning the drain pump	26
4.4 Installation types	8	16.4 Cleaning the rubber gasket	29
4.5 Removing the transit bolts.....	10	17 Troubleshooting	30
4.6 Connecting the appliance.....	11	17.1 Emergency release	32
4.7 Aligning the appliance	12	17.2 Restart the appliance.	33
5 Before using for the first time	12	18 Transportation, storage and disposal	33
5.1 Starting an empty washing cycle.....	12	18.1 Removing the appliance	33
6 Familiarizing yourself with your appliance	14	18.2 Inserting the transit bolts	33
6.1 Appliance	14	18.3 Using the appliance again	33
6.2 Detergent drawer	14	18.4 Disposal of your old appliance.....	34
6.3 Control panel.....	15	19 Customer Service	34
7 Display	16	19.1 Model number (E-Nr.) and production number (FD).....	34
8 Buttons	18	20 Technical specifications	34
9 Programs	19		
10 Accessories	22		
11 Laundry	22		
11.1 Preparing the laundry	22		
12 Detergents and care products	22		
13 Basic Operation	22		
13.1 Switching on the appliance.....	22		
13.2 Setting a program	22		
13.3 Opening the door	23		
13.4 Loading laundry	23		



IMPORTANT SAFETY INSTRUCTIONS

READ AND SAVE THESE INSTRUCTIONS

Read all of the instructions carefully before using the appliance. In order to reduce the risk of fire, electric shocks and personal injuries when using the appliance, follow the basic safety precautions, including the following safety instructions.

1.1 Safety definitions

Here you can find explanations of the safety signal words used in this manual.

1.2 General information



- Read this manual carefully.
- Keep the manual and the product information in a safe place for future reference or for the next owner.
- Do not connect the appliance if it has been damaged in transit.

1.3 Intended use

Only a licensed professional may connect appliances without plugs. The manufacturer is not responsible for damage caused by incorrect connections. An incorrect connection is not covered by the Statement of Limited Product Warranty.

Only use this appliance:

- For washing machine-washable fabrics and hand-washable wool in accordance with the care label.
- With tap water and commercially available, washing-machine-suitable detergents and care products.
- for normal household use and in enclosed spaces in a residential environment.
- Up to an altitude of 13,100 ft (4000 m) above sea level.

1.4 Restrictive Use

This appliance is not intended for use by persons (including children) with reduced physical, sensory or mental capabilities, or lack of experience and knowledge,

WARNING

This indicates that death or serious injuries may occur as a result of non-observance of this warning.

CAUTION

This indicates that minor or moderate injuries may occur as a result of non-observance of this warning.

NOTICE:

This indicates that damage to the appliance or property may occur as a result of non-compliance with this advisory.

Note: This alerts you to important information and/or tips.

unless they have been given supervision or instruction concerning use of the appliance by a person responsible for their safety.

Do not let children play with the appliance.

Cleaning and user maintenance must not be performed by children unless they are being supervised.

Keep children under the age of 3 and pets away from the appliance.

1.5 Grounding instructions

This appliance must be grounded. In the event of malfunction or breakdown, grounding will reduce the risk of electric shock by providing a path of least resistance for electric current. This appliance is equipped with a cord having an equipment-grounding conductor. Installation, electrical connections and grounding must comply with all applicable codes.

WARNING

Improper connection of the equipment-grounding conductor can result in a risk of electric shock.

- ▶ Check with a qualified electrician or authorized service representative if you are in doubt whether the appliance is properly grounded.



IMPORTANT SAFETY INSTRUCTIONS

READ AND SAVE THESE INSTRUCTIONS

1.6 Safe installation

WARNING

Incorrect installation is dangerous.

- ▶ Connect and operate the appliance only in accordance with the specifications on the rating plate.
- ▶ Connect the appliance to a power supply with alternating current only via a correctly installed socket outlet with grounding.
- ▶ The protective conductor system of the domestic electrical installation must be properly installed. The installation must have a sufficiently large cable cross-section.
- ▶ When using a residual current circuit breaker, only use a type with the  mark.
- ▶ Never equip the appliance with an external switching device, e.g. a timer or remote control.
- ▶ When the appliance is installed, the mains plug of the power cord must be freely accessible. If free access is not possible, an isolating switch must be integrated into the permanent electrical installation according to the installation regulations.

- ▶ When installing the appliance, check that the power cord is not trapped or damaged.

If the insulation of the power cord is damaged, that can be dangerous.

- ▶ Never let the power cord come into contact with hot appliance parts or heat sources.
- ▶ Never let the power cord come into contact with sharp points or edges.
- ▶ Never kink, crush or modify the power cord.

WARNING

It is dangerous to use an extended power cord and non-approved adapters.

- ▶ Do not use extension cords or multiple socket strips.
- ▶ Only use adapters and power cords approved by the manufacturer.
- ▶ If the power cord is too short and a longer one is not available, please contact an electrician to have the domestic installation adapted.

WARNING

The heavy weight of the appliance may result in injury when lifted.

- ▶ Do not lift the appliance on your own.

If this appliance is not correctly installed in a washer-dryer stack, the installed appliance may fall.

- ▶ Only stack the dryer on a washing machine using the connection kit from the dryer manufacturer. No other installation method is permitted.
- ▶ Do not install the appliance in a washer-dryer stack if the dryer manufacturer does not offer a suitable connection kit.
- ▶ Do not install appliances from different manufacturers and with varying depths and widths in a washer-dryer stack.
- ▶ Do not install a washer-dryer stack on a platform; the appliances may tip over.

WARNING

Children may pull packaging material over their heads, or wrap themselves up in it and suffocate.

- ▶ Keep packaging material away from children.
- ▶ Do not allow children to play with packaging material.

CAUTION

The appliance may vibrate or move when in use.

- ▶ Place the appliance on a clean, even, solid surface.
- ▶ Align the appliance using the appliance feet and a spirit level.

If hoses and power cords have been laid incorrectly, this causes a tripping hazard.

- ▶ Lay hoses and power cords in such a way that there is no risk of tripping.

If the appliance is moved by holding onto protruding components, such as the appliance door, the parts may break off.

- ▶ Do not move the appliance by holding onto protruding parts.

CAUTION

Touching sharp edges on the appliance may lead to cuts.

- ▶ Do not touch the sharp edges on the appliance.
- ▶ Wear protective gloves when installing and transporting the appliance.

1.7 Safe use

WARNING

If the appliance or the power cord is damaged, this is dangerous.

- ▶ Never operate a damaged appliance.
- ▶ Never pull on the power cord to unplug the appliance. Always unplug the appliance at the power outlet.



IMPORTANT SAFETY INSTRUCTIONS

READ AND SAVE THESE INSTRUCTIONS

- ▶ If the appliance or the power cord is damaged, immediately unplug the power cord or switch off the breaker in the circuit breaker box and turn off the water tap.
- ▶ Call Customer Service. → *Page 34*

Moisture intrusion may cause an electric shock.

- ▶ Use the appliance in enclosed spaces only.
- ▶ Never expose the appliance to intense heat or humidity.
- ▶ Do not use steam cleaners, high-pressure cleaners, hoses or sprays to clean the appliance.

WARNING

Children can lock themselves in the appliance, thereby putting their lives at risk.

- ▶ Do not install the appliance behind a door as this may obstruct the appliance door or prevent it from opening.
- ▶ With redundant appliances, pull out the mains plug of the power cord, cut through the power cord and remove the appliance door.

When spinning larger, waterproof items of laundry, imbalances may arise and lead to injuries.

- ▶ Do not wash and spin larger items of laundry, such as blankets or mattress covers, in the appliance.

WARNING

Children may breathe in or swallow small parts, causing them to suffocate.

- ▶ Keep small parts away from children.
- ▶ Do not allow children to play with small parts.

WARNING

A hot-water system that has not been used for 2 weeks or more may produce flammable hydrogen gas.

- ▶ Before using the appliance open all hot-water faucets for a few minutes to release hydrogen gas.
- ▶ During these minutes, do not smoke or use an open flame.

WARNING

Detergents and care products may result in poisoning if consumed.

- ▶ If accidentally swallowed, seek medical advice.
- ▶ Keep detergents and care products out of the reach of children.

WARNING

Laundry that has been pretreated with flammable cleaning agents that contain solvents may cause an explosion in the appliance.

- ▶ Rinse pretreated laundry thoroughly with water before washing.

CAUTION

The covering plate may break if you stand on or climb onto the appliance.

- ▶ Do not stand on or climb onto the appliance. The appliance may tip over if you sit on or lean against the open door.
- ▶ Do not sit on or lean against the appliance door.
- ▶ Do not place any objects on the appliance door. Reaching into the drum while it is still turning may cause hand injuries.
- ▶ Wait for the drum to come to a complete stop before reaching inside.

CAUTION

When you wash at high temperatures, the detergent solution becomes hot.

- ▶ Do not touch the hot detergent solution.

CAUTION

If the detergent drawer is opened, detergent and care products may spray out from the appliance. Contact with eyes or skin may cause irritation.

- ▶ Rinse eyes and/or skin thoroughly with clean water if they come into contact with detergents or care products.
- ▶ If accidentally swallowed, seek medical advice.
- ▶ Keep detergents and care products out of the reach of children.

1.8 Safe cleaning and maintenance

WARNING

Improper repairs are dangerous.

- ▶ Never make any technical modifications to the appliance or its features.
- ▶ Do not tamper with controls.
- ▶ Repairs to the appliance should only be performed by authorized service providers.
- ▶ Only original spare parts may be used to repair the appliance.



IMPORTANT SAFETY INSTRUCTIONS

READ AND SAVE THESE INSTRUCTIONS

- ▶ If the power cord of this appliance becomes damaged, it must be replaced by the manufacturer, the manufacturer's Customer Service, or an authorized service provider in order to prevent injury.

Moisture intrusion may cause an electric shock.

- ▶ Before cleaning, pull out the power plug or switch off the circuit breaker in the circuit breaker box.
- ▶ Do not use steam cleaners, high-pressure cleaners, hoses or sprays to clean the appliance.

WARNING

The use of non-original spare parts and non-original accessories is dangerous.

- ▶ Only use the manufacturer's original spare parts and original accessories.

WARNING

Poisonous fumes may be given off if you use cleaning agents that contain solvents.

- ▶ Do not use cleaning agents that contain solvents.

1.9 State of California Proposition 65 Warnings

This product may contain a chemical known to the State of California, which can cause cancer or reproductive harm. Therefore, the packaging of your product may bear the following label as required by California:

STATE OF CALIFORNIA PROPOSITION 65 WARNING:



WARNING

Cancer and Reproductive Harm - www.P65Warnings.ca.gov

2 Preventing material damage

NOTICE:

The functionality of the appliance may be impaired if you use the wrong quantity of fabric softener, detergent, care product or cleaning agent.

- ▶ Follow the dosage recommendations from the manufacturer.
- ▶ Only use fabric softeners or products to eliminate static that are specifically recommended for this purpose by the product manufacturer.

Exceeding the maximum load capacity impairs the function of the appliance.

- ▶ Observe the maximum load capacity for each programme and do not exceed it.

→ "Programs", Page 19

The appliance is secured for transportation using transport locks. Transit bolts which have not been removed may result in material damage and damage to the appliance.

- ▶ Before starting up the appliance, remove the transit bolts completely and keep them in a safe place.
- ▶ Before transport, fit the transit bolts fully in order to prevent damage in transit.

Material damage may be caused if the water inlet hose is connected incorrectly.

- ▶ Tighten the screw connections on the water inlet until they are hand-tight.
- ▶ Connect the water inlet hose directly to the water tap, without any additional connecting elements such as adapters, extensions, or valves.
- ▶ Ensure that the inner diameter of the water tap is at least 17 mm.
- ▶ Make sure that the length of the thread on the connection to the water tap is at least 10 mm.

If the water pressure is too high or too low, this may impair functioning of the appliance.

- ▶ Make sure that the water pressure in the water supply system is at least 14.5 psi (100 kPa) and max. 145 psi (1000 kPa).
- ▶ If the water pressure exceeds the maximum value specified, a pressure-reducing valve must be installed between the drinking water connection and the hose set of the appliance.
- ▶ Do not connect the appliance to the mixer tap of an unpressurised hot-water boiler.

Modified or damaged water hoses may result in material damage and damage to the appliance.

- ▶ Never kink, crush, modify or cut through water hoses.
- ▶ Only use the water hoses supplied with the appliance or genuine spare hoses.
- ▶ Never re-use water hoses that have been used before.

Operating the appliance using water that is dirty or too hot may lead to material damage and damage to the appliance.

- ▶ Only operate the appliance with cold or warm (max. 60 °C/140 °F) mains water.

Unsuitable cleaning agents may damage the surfaces of the appliance.

- ▶ Do not use strong or abrasive cleaning agents.

- ▶ Do not use cleaning agents with a high alcohol content.
- ▶ Do not use hard scouring pads or cleaning sponges.
- ▶ Clean the appliance with nothing but water and a soft, damp cloth.
- ▶ Remove all detergent residue, spray residue or other residues immediately if they come into contact with the appliance.

3 Environmental protection and energy-saving

3.1 Disposal of packaging

The packaging materials are environmentally compatible and can be recycled.

- ▶ Sort the individual components by type and dispose of them separately.

3.2 Save energy and conserve resources

If you follow these instructions, your appliance will use less power and water.

- Choose programs with low temperatures and longer wash times and use maximum load capacity.
→ Page 19
- Add detergent based on the laundry's degree of soiling.
- Reduce the washing temperature for lightly and normally soiled laundry.
- Set the maximum spin speed if you want to dry the laundry in a tumble dryer afterwards.
- Wash the laundry without prewash.

3.3 Energy-saving mode

If you do not use the appliance for a brief period, it automatically switches to energy-saving mode. All displays go out and **Start Pause** flashes.

Energy-saving mode ends when you use the appliance again.

4 Installation and connection

Install the appliance according to the manufacturer's instructions and local codes.

4.1 Unpacking the appliance

NOTICE:

Objects remaining in the drum that are not designed for operation with the appliance may cause material damage and damage to the appliance.

- ▶ Remove these objects, along with all supplied accessories, from the drum before starting the appliance.

1. Remove any packaging and protective covers completely from the appliance.

→ "Disposal of packaging", Page 7

2. Check the appliance for visible damage.
3. Open the door. → *Page 23*
4. Remove any accessories from the drum.
5. Close the door.

4.2 Included in delivery

After unpacking all the parts, check for any damage in transit and for completeness of delivery.

NOTICE:

If the appliance is operated with incomplete or defective accessories, the appliance may not be able to operate properly, or this may result in material damage and damage to the appliance.

- ▶ Do not operate the appliance with incomplete or defective accessories.
- ▶ Replace the accessories in question before operating the appliance.
→ *"Accessories", Page 22*

Note: The appliance has undergone a function test at the factory. This may cause water stains in the appliance, which the first wash cycle removes.

The delivery consists of the following:

- Washing machine
- Accompanying documents
- Transit bolts
- Cover cap¹
- Water inlet hoses
→ *"Connecting the water inlet hoses", Page 11*
- Elbow for securing the water outlet hose

4.3 Requirements for the installation location

⚠ WARNING

The appliance contains live parts. Touching live parts is dangerous.

- ▶ Do not operate the appliance without a cover cap.

⚠ WARNING

When using the appliance on a base, the appliance may tip over.

- ▶ Always secure the feet of the appliance to a base using the manufacturer's fixing brackets → *Page 22* before using the appliance for the first time.

NOTICE:

If residual water in the appliance freezes, this may cause damage to the appliance.

- ▶ Do not install or operate this appliance anywhere that is liable to experience frost and/or outdoors.

If the appliance is tilted at an angle greater than 40°, residual water may leak out of the appliance and cause material damage.

- ▶ Tilt the appliance carefully.
- ▶ Transport the appliance in an upright position.

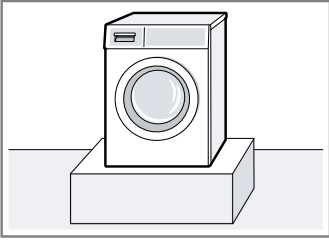
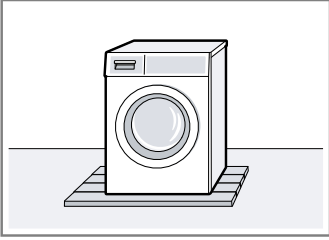
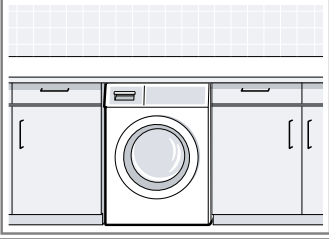
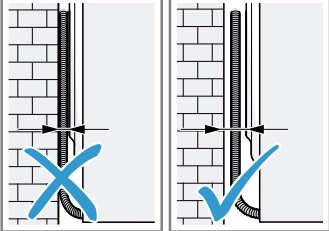
Installation location	Requirements
Base 	Secure the appliance with fixing brackets → <i>Page 22</i> .
Wooden joist floor 	Place the appliance on a water-resistant wooden board (minimum thickness of 1.18 in. (30 mm)) which is screwed tightly to the floor.
Kitchen unit 	Only install the appliance underneath a continuous countertop that is securely connected to adjacent cabinets. Required niche width: 23.6 in. (60 cm).
Against a wall 	Do not trap the power cord or the hoses between the wall and the appliance.

4.4 Installation types

The appliance can be set up in a closed cabinet either in a washer-dryer stack or free-standing.

⚠ WARNING

If this appliance is not correctly installed in a washer-dryer stack, the installed appliance may fall.

- ▶ Only stack the dryer on a washing machine using the connection kit from the dryer manufacturer. No other installation method is permitted.
- ▶ Do not install the appliance in a washer-dryer stack if the dryer manufacturer does not offer a suitable connection kit.
- ▶ Do not install appliances from different manufacturers and with varying depths and widths in a washer-dryer stack.
- ▶ Do not install a washer-dryer stack on a platform; the appliances may tip over.

¹ The number of cover caps varies depending on the model.

Installation in a closed cabinet

Notes

- In case of set up in a washer-dryer stack, please observe the requirements for the installation location.
- Keep the clearance at the rear of the appliance to the cabinet wall as small as possible, depending on the ventilation openings and the water connection. For installation in a washer-dryer stack, a larger clearance is required at the rear of the appliance for the dryer's ventilation openings.
- To achieve shorter drying times, operate the appliance with the cabinet door open. Operating the appliance in a closed cabinet with only the minimum required ventilation openings may lead to longer drying times.

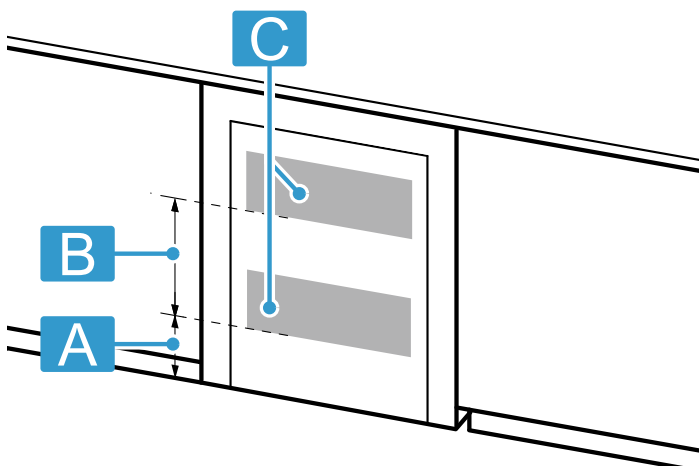

A	3.0" (7.6 cm)
B	14.0" (35.6 cm)
C	63.0 sq. in. (404.0 cm ²) ¹

¹ Minimum area for each ventilation opening.

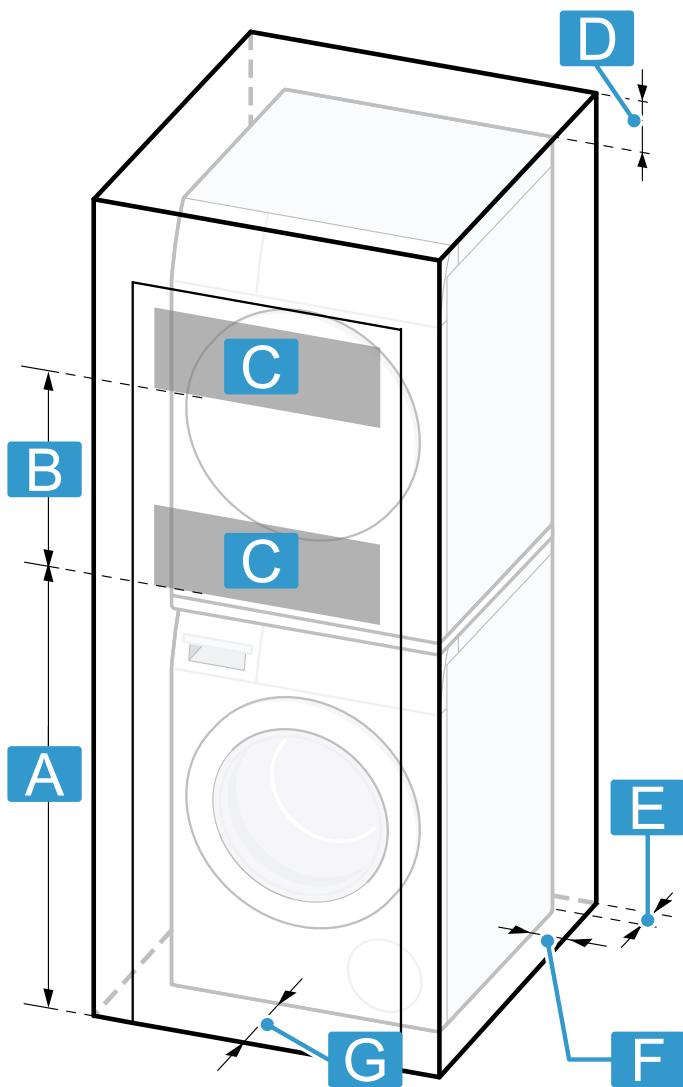

A	37.0" (94.0 cm)
B	26.0" (66.0 cm)
C	63.0 sq. in. (404.0 cm ²) ¹
D	6.25" (16.0 cm)
E	2.5" (6.4 cm)
F	0.6" (1.5 cm) ²
G	2.4" (6.1 cm)

¹ Minimum area for each ventilation opening.

² Valid for both sides of the appliance

The specified dimensions of the ventilation opening applies to each position and must not be divided between the upper and lower positions.
The specified dimensions of the ventilation openings apply to each position and must not be divided between the upper and lower positions.

Installation in an open cabinet

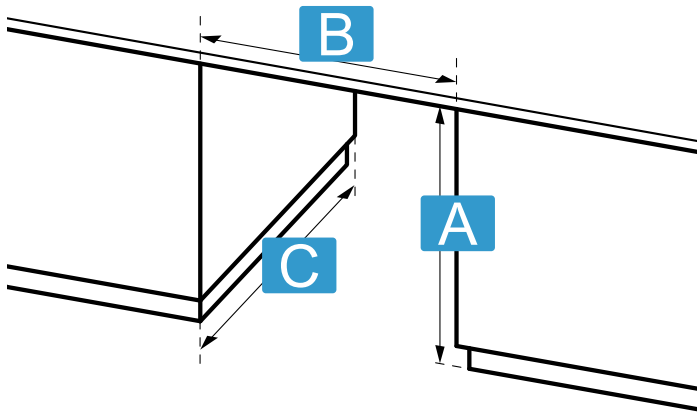

A 34.5" (87.6 cm)

B 23.8" (60.5 cm)

C 28.0" (71.1 cm)

4.5 Removing the transit bolts

The appliance is secured for transportation using transit bolts on the rear of the appliance.

Note: Keep the transit bolt screws and the sleeves in a safe place for future transport.

1. Remove the hose ① and the power cord ② from the holders.

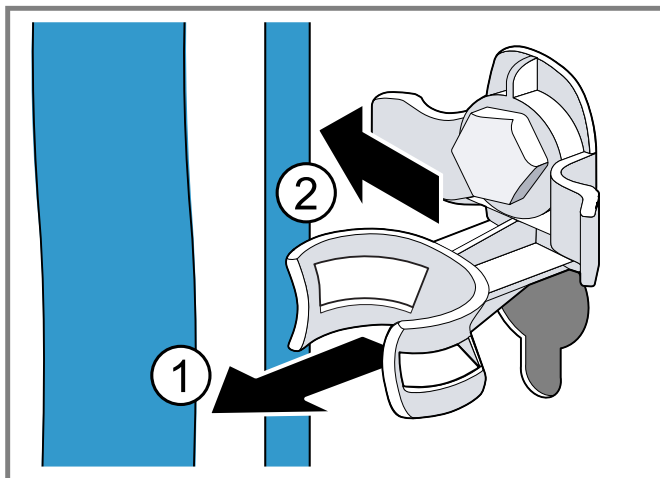

2. Unscrew ① and remove ② all of the screws for the 4 transit bolts using a 13 mm wrench.

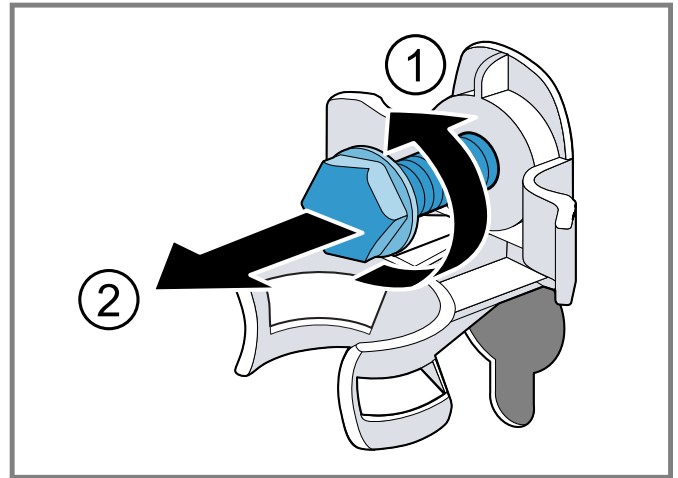

3. Remove the 4 sleeves.

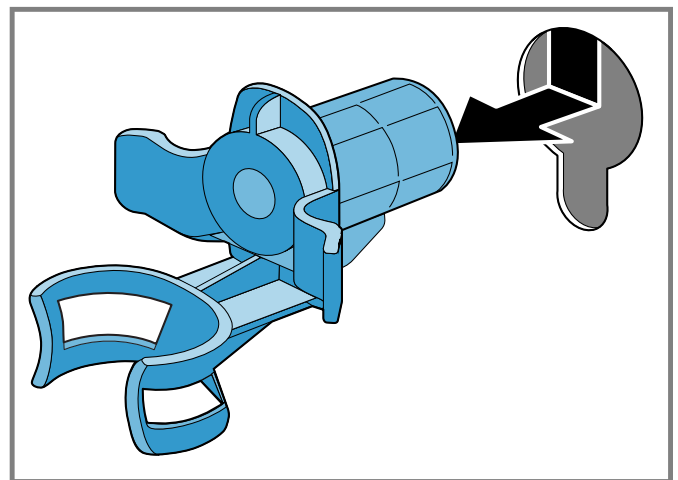

4. Insert the cover cap and push it downwards.

Notes

- Note the number of cover caps included in the scope of delivery
- If four cover caps are included in the scope of delivery, insert the cover caps in the four openings for the transit bolts.

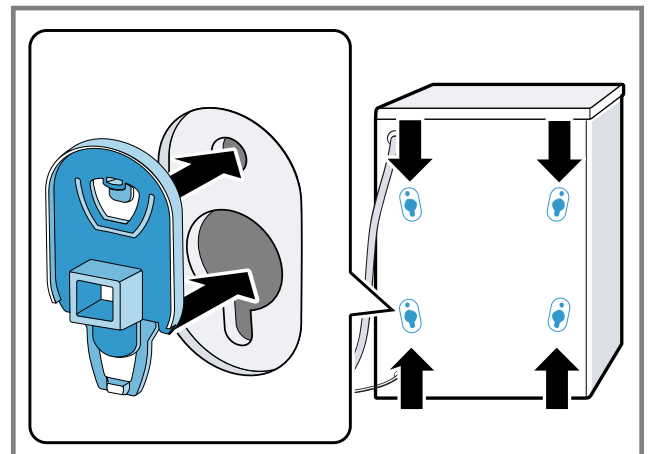

- If one cover cap is included in the scope of delivery, insert the cover cap in the bottom left opening for the transit bolt.

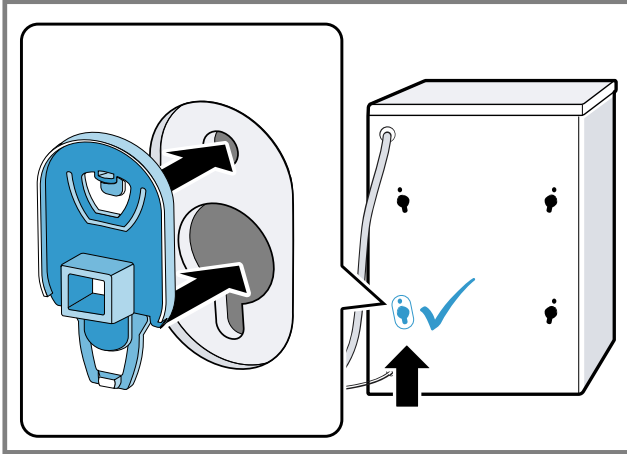

Note: To install the transport locks to transport the appliance, perform these steps again in the reverse order.

4.6 Connecting the appliance

Connecting the water inlet hoses

NOTICE:

Material damage may be caused if the water inlet hose is connected incorrectly.

- ▶ Tighten the screw connections on the water inlet until they are hand-tight.

1. Connect the water inlet hose for hot water **a** (red) and cold water **b** (blue) to the appliance.

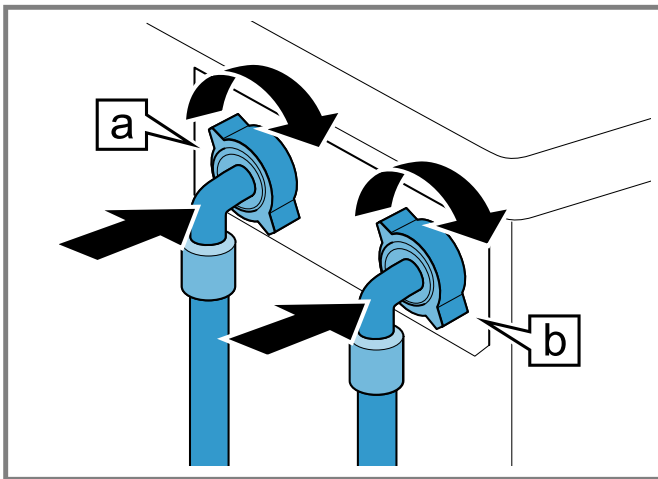

2. Connect the water inlet hose for hot water **a** (red) and cold water **b** (blue) to the faucet (26.4 mm = 3/4").

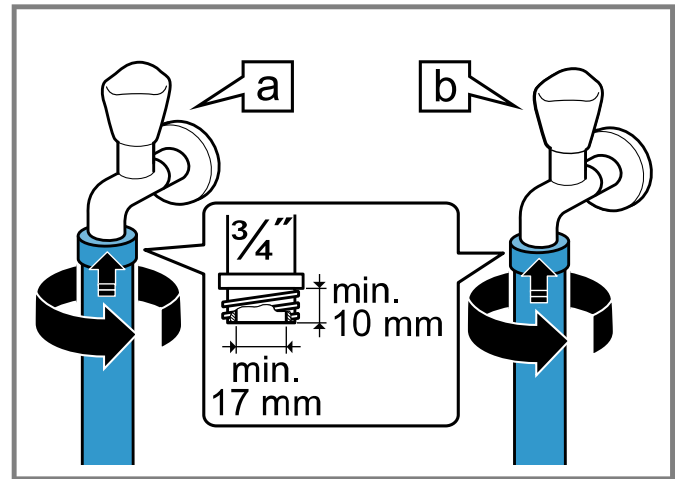

If there is no faucet for hot water, only connect the water inlet hose for cold water. Cover the hot water connection on the appliance in order to protect it from dirt.

Tip: To protect against dirt, use a 3/4" end cap on the hot water connection of the appliance.

3. Open the faucets carefully and check that the connection points are tight.

Water outlet connection types

This information is intended to help you to connect this appliance to the water outlet.

NOTICE:

When draining, the water drain hose is subject to water pressure and may come loose from the installed connection point.

- ▶ Secure the water drain hose against unintentional loosening.
- In the event of a blocked or covered outlet, accumulated wastewater can flow back into the appliance.
- ▶ Before operating the appliance, ensure that the wastewater drains away quickly and eliminate any blockages.

Note: Observe the draining heights.

The maximum draining height is 39 in. (100 cm).

Siphon

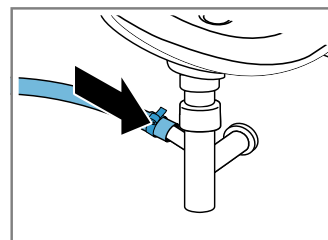

Secure the connection point with a (0.94–1.57 in. (24–40 mm)) hose clamp.

Washbasin

Fix and secure the water outlet hose with an elbow.

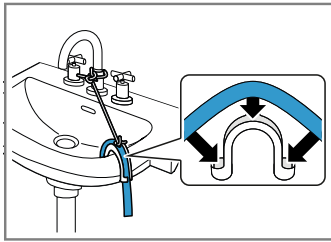

Plastic pipe with rubber sleeve or gully

Fix and secure the water outlet hose with an elbow.

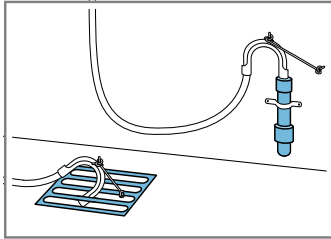

Connecting the appliance to the electricity supply

Note: Your electrical domestic installation for this appliance must comply with the local legal provisions and safety regulations, and should include a residual current circuit breaker.

1. Insert the power adapter with the line side into a suitable socket close to the appliance.
Observe the user manual that is enclosed with the power adapter.
2. Insert the power plug of the appliance's power cord in a socket outlet with grounding nearby.
The connection details of the appliance can be found under Technical data → Page 34.
3. Check the power plug is inserted properly.

4.7 Aligning the appliance

In order to reduce noise and vibrations, and to prevent the appliance from moving, align the appliance correctly.

1. Use a 17 mm wrench to loosen the lock nuts in a clockwise direction.

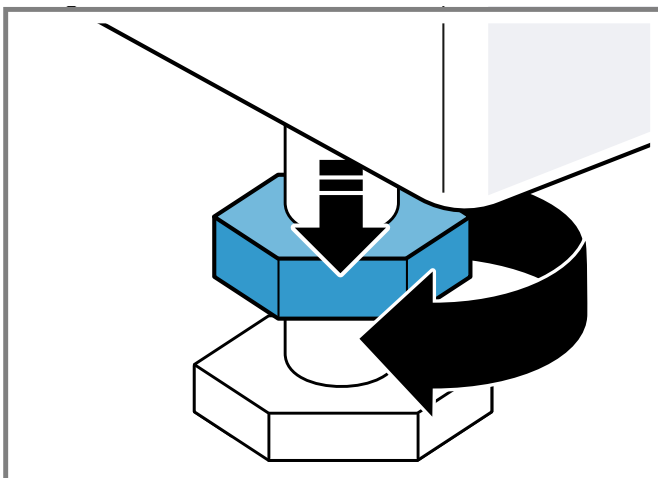

2. To align the appliance, turn the appliance feet. Check that the appliance is level using a spirit level.

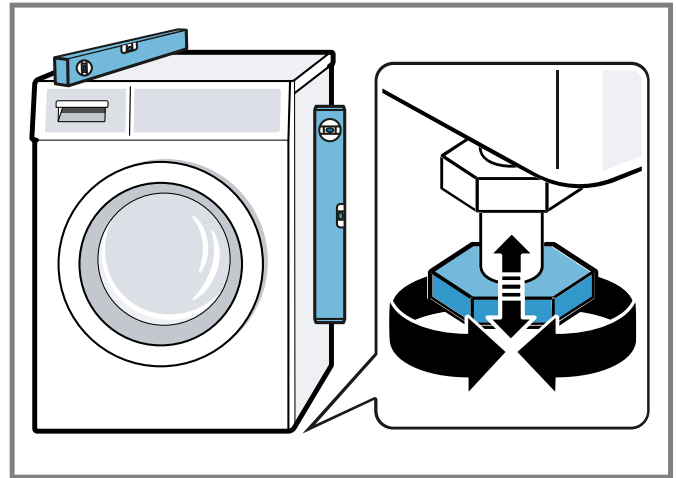

All appliance feet must stand firmly on the ground.

3. Use a 17 mm wrench to tighten the lock nuts against the housing until they are hand-tight.

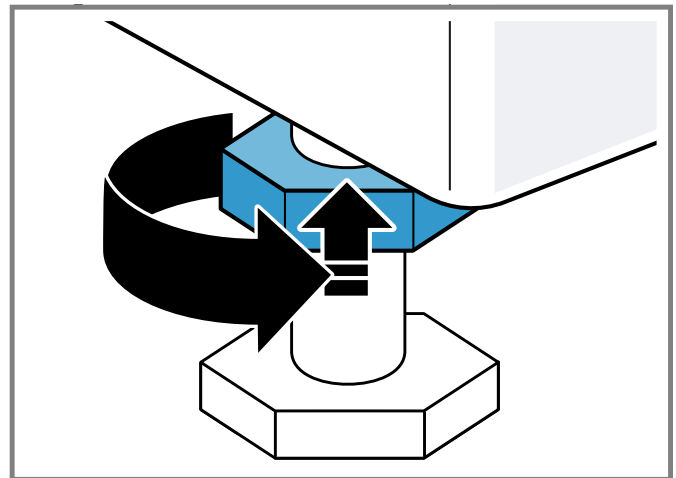

In doing so, hold the appliance foot tight and do not adjust its height.

5 Before using for the first time

Prepare the appliance for use.

5.1 Starting an empty washing cycle

Your appliance was inspected thoroughly before leaving the factory. To remove any residual water, run the first wash cycle without any laundry.

1. Turn the program selector to **Drum Clean**.
2. Close the door.
3. Pull out the detergent drawer.

4. Pour approximately 4.3 cups (1 liter) of mains water into compartment II.

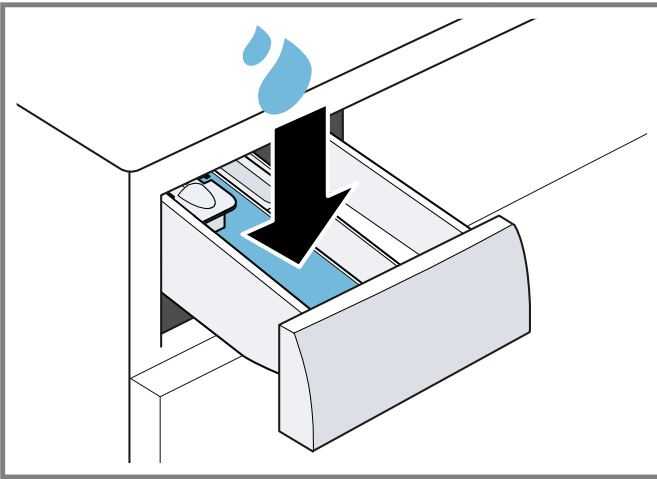

5. Add washing powder containing oxygen bleach to compartment II.

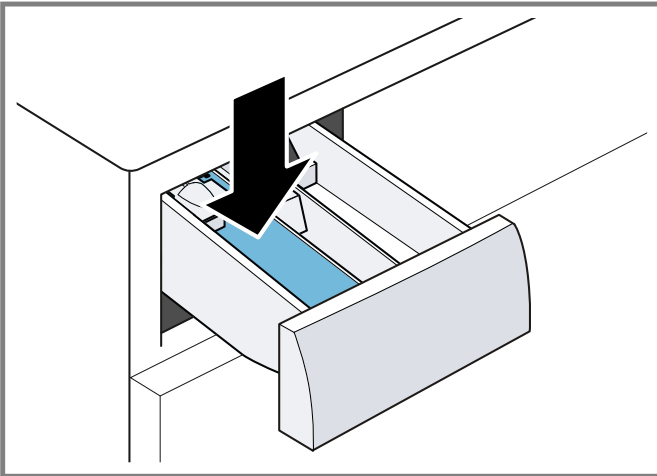

To prevent foaming, use only half of the amount of detergent recommended by the detergent manufacturer for light soiling. Do not use detergent suitable for woolens or delicates.

6. Push in the detergent drawer.
7. Press **Start Pause** to start the program.
 - ✓ The display shows the remaining program duration.
 - ✓ After the program has ended, the display shows: **End**.
8. Start the first wash cycle or set the program selector to **Off** to switch off the appliance.
 - "Basic Operation", Page 22

6 Familiarizing yourself with your appliance

6.1 Appliance

Here you can find an overview of the parts of your appliance.

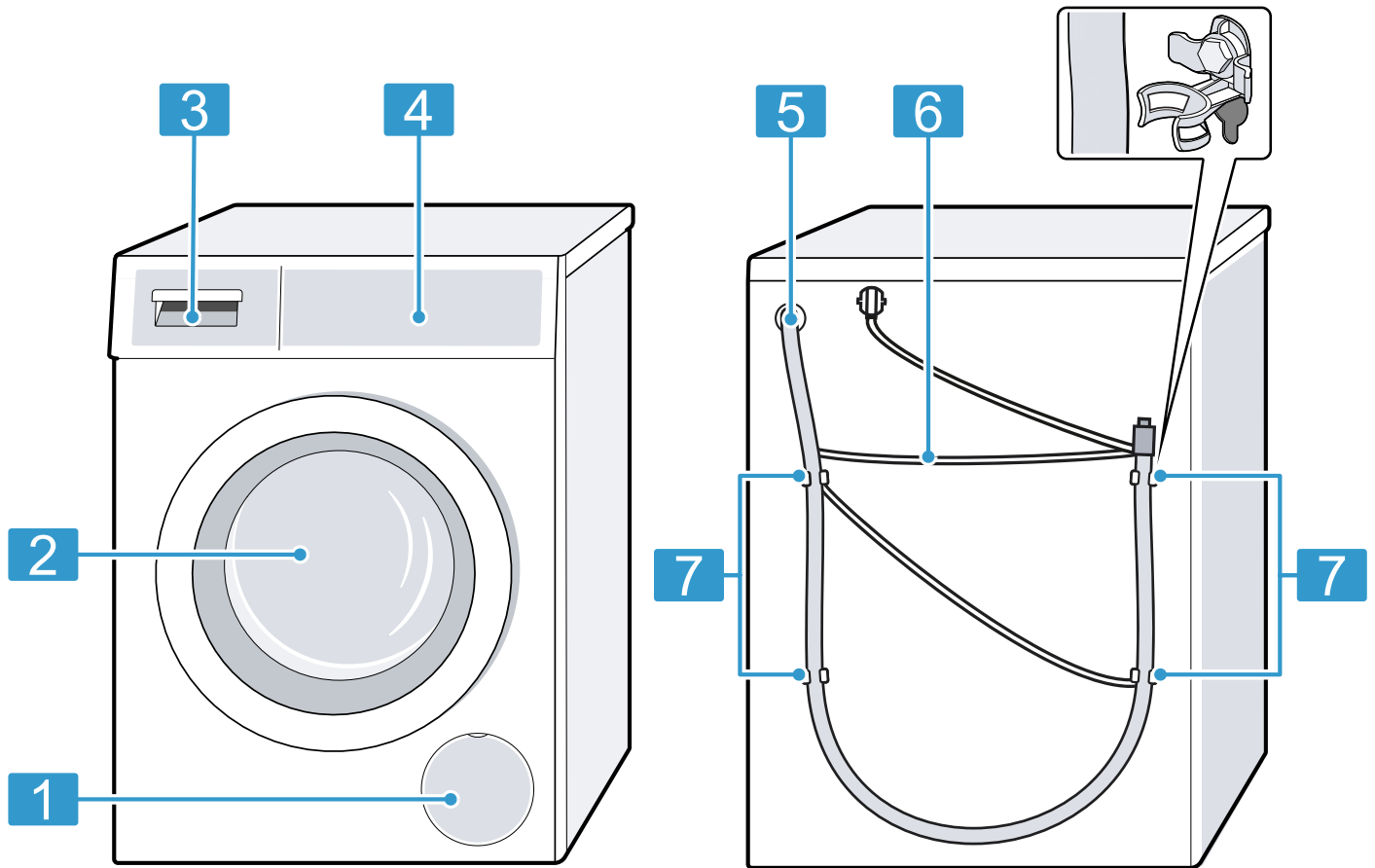

On certain models, specific details such as the color and shape may differ from those pictured.

- | | |
|---|--|
| 1 | Maintenance flap for the drain pump → <i>Page 26</i> |
| 2 | Door → <i>Page 23</i> |
| 3 | Detergent drawer → <i>Page 14</i> |
| 4 | Control panel → <i>Page 15</i> |
| 5 | Water drain hose → <i>Page 11</i> |
| 6 | Power cord → <i>Page 12</i> |
| 7 | Transit bolts |

6.2 Detergent drawer

Note: Observe the manufacturer's instructions on the use and dosage of the detergent and care product and the information in the program descriptions.

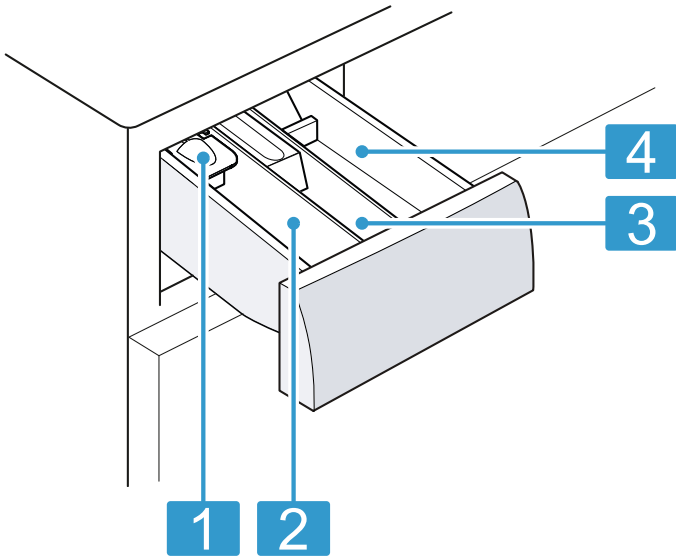

- 1** Measuring aid for liquid detergent → *Page 23*

- 2** Compartment II: Detergent for the main wash

- 3** Compartment ⌘: Fabric softener

- 4** Compartment I: Detergent for prewash

6.3 Control panel

You can use the control panel to configure all functions of your appliance and to obtain information about the operating status.

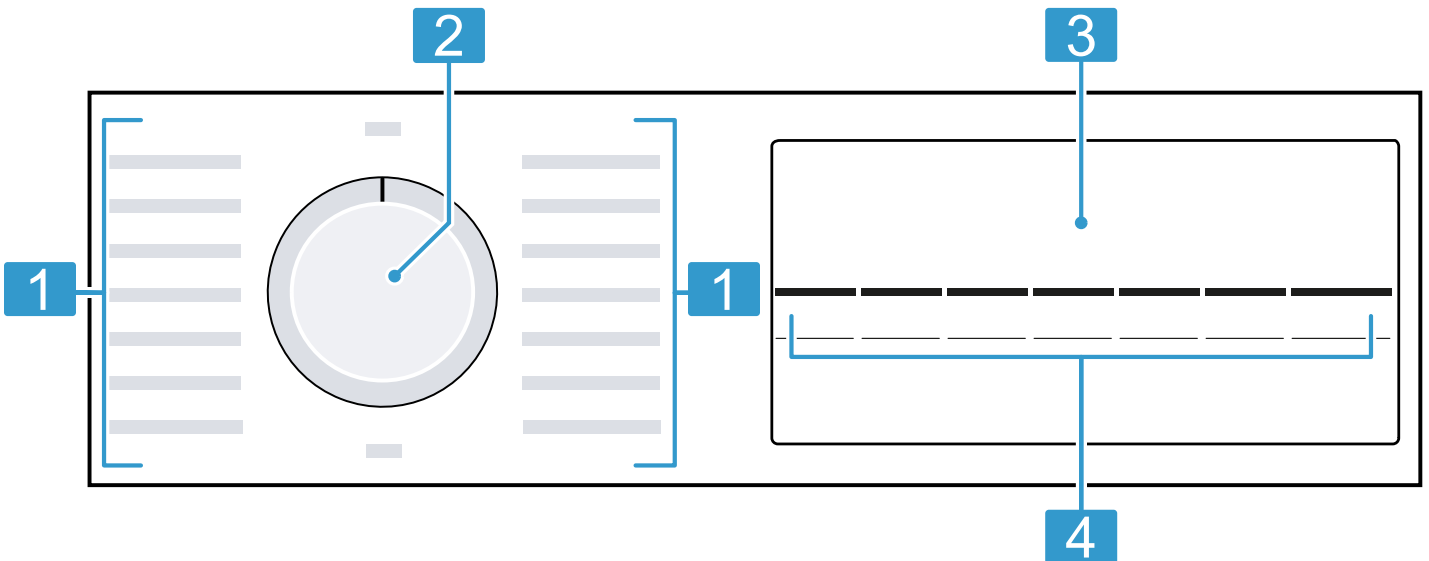

- 1** Programs → *Page 19*

- 2** Program selector → *Page 22*

- 3** Display → *Page 16*

- 4** Buttons → *Page 18*

7 Display

The display shows the current settings, options or relevant information.

Depending on the program status, the display shows some information in the **00:00** area, e.g. End.

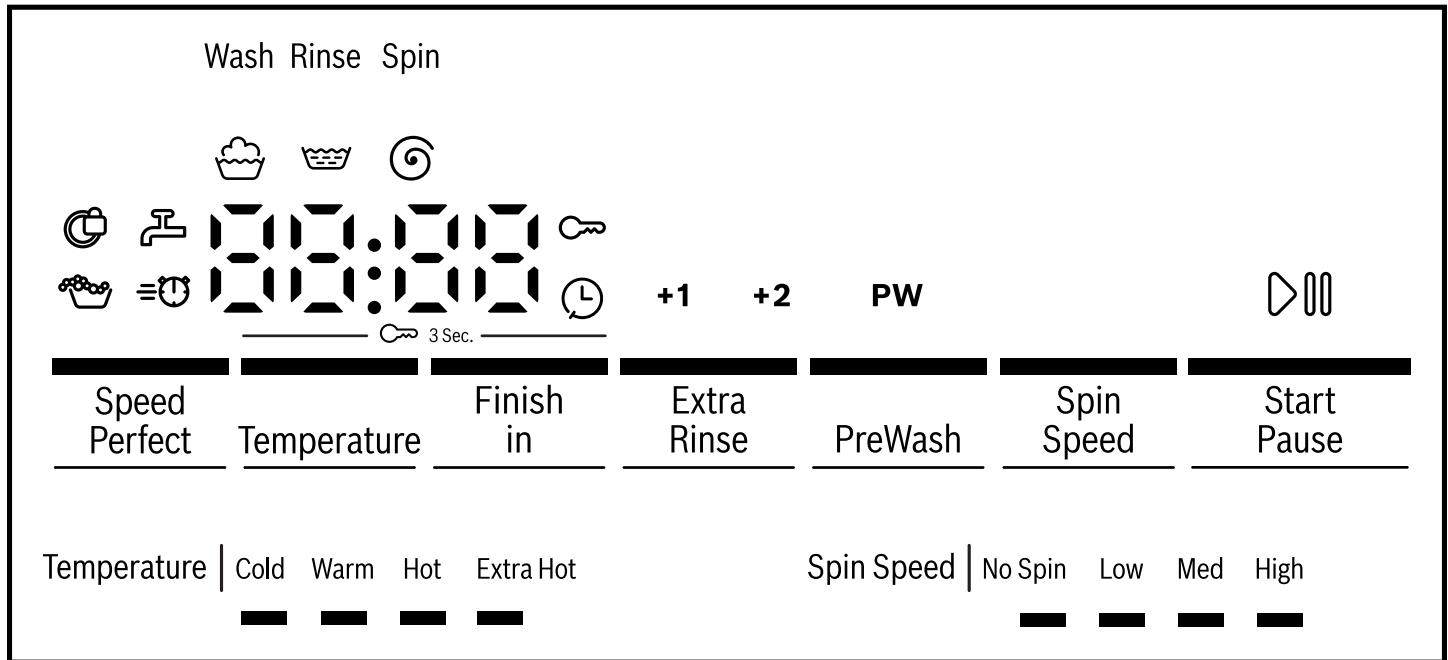

Example: Display

Display	Description
00:40 ¹	Expected program duration or program time remaining in hours and minutes.
10h ⌚ ¹	Program end time → "Buttons", Page 18
No Spin - High	Set spin speed. → Page 18 No Spin: No spin cycle, draining only
▶	Start, cancel or pause <ul style="list-style-type: none"> ▪ Lights up: The program is running and can be cancelled or paused. ▪ Flashes: The program can be started or continued.
🪣	Program status: Washing
🪣	Program status: Rinsing
🌀	Program status: Spinning
End	Program status: Program end
🔑	<ul style="list-style-type: none"> ▪ Lights up: The control panel lock is activated. ▪ Flashes: The control panel lock is activated and the appliance has been operated.
+1 +2	Additional rinse cycles are activated. → Page 18
PW	Prewash is activated. → Page 18
⌚	Shortened program duration is activated. → "Buttons", Page 18
🪣	The appliance has detected too much foam. → 🪣 or heavy foam build-up.", Page 31
🔒	<ul style="list-style-type: none"> ▪ Lights up: The door is locked and cannot be opened. ▪ Flashes: The door is not closed. ▪ Off: The door is unlocked and can be opened.

¹ Example

Display	Description
	<ul style="list-style-type: none">■ No water pressure.■ The water pressure from the tap is too low.
E:35 ¹	Error code, error display, signal. → <i>Page 30</i>
¹ Example	

8 Buttons

The selection of program settings depends on the program that is set.

Button	Selection	More information
Start Pause	<ul style="list-style-type: none"> ■ Start ■ Cancel ■ Pause 	Start, cancel or pause the program.
Speed Perfect	<ul style="list-style-type: none"> ■ Activate ■ Deactivate 	Activate or deactivate a shorter program duration. Note: Energy consumption increases. The washing result is not affected by this.
Finish in	Up to 24 hours	Set the program end time. The program duration is already included in the set number of hours. Once the program has started, the program duration is displayed.
Temperature	Cold - Extra Hot	Adjust the temperature.
Spin Speed	No Spin - High	Adjust the spin speed or deactivate the spin cycle. If No Spin is selected, the water is drained and the spin cycle is deactivated. The laundry stays wet inside the drum.
 3 Sec.	<ul style="list-style-type: none"> ■ Activate ■ Deactivate 	→ "Control panel lock", Page 24
PreWash	<ul style="list-style-type: none"> ■ Activate ■ Deactivate 	Activate or deactivate prewash, e.g., for washing heavily soiled laundry. Note: Add the detergent for the prewash in compartment I and the detergent for the main wash in compartment II of the detergent drawer. → "Detergent drawer", Page 14
Extra Rinse	<ul style="list-style-type: none"> ■ +1 ■ +2 	Activate or deactivate up to two additional rinse cycles. Recommended for particularly sensitive skin or in regions with very soft water.

9 Programs

Notes

- The laundry's care labels provide you with additional information on program selection.
- The program's temperature setting guarantees that the recommended temperature on the care label is not exceeded. The temperature that is reached in the appliance may differ from the set temperature. This means that the best possible washing performance is achieved with optimal energy efficiency.

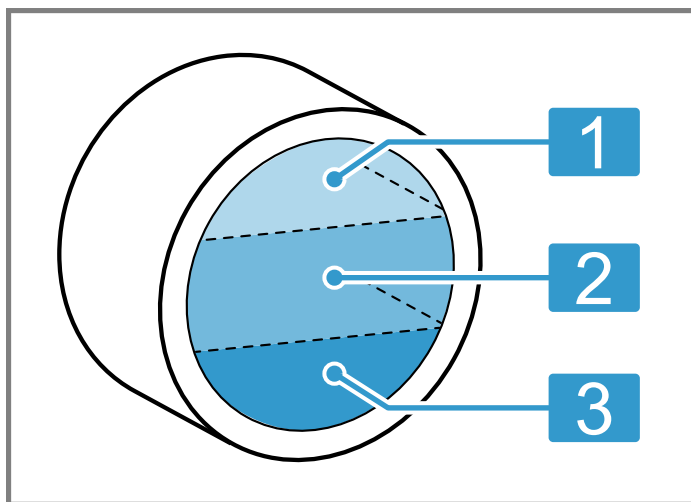

1	Large load
2	Medium load
3	Small load

Program	Description	Max. load
Cotton Light Soil	Wash hard-wearing items made from cotton or linen. Short program for normally soiled laundry. Program setting: <ul style="list-style-type: none"> ■ Max. temperature: Extra Hot ■ Max. spin speed: High 	medium
Cotton Normal	Wash hard-wearing items made from cotton or linen. Suitable for normally soiled laundry. Also suitable as a short program for normally soiled laundry when you activate Speed Perfect. Program setting: <ul style="list-style-type: none"> ■ Max. temperature: Extra Hot ■ Max. spin speed: High 	large medium ¹
Heavy Duty	Wash hard-wearing items made from cotton or linen. Suitable for heavily to lightly soiled laundry. Program setting: <ul style="list-style-type: none"> ■ Max. temperature: Extra Hot ■ Max. spin speed: High 	large
Perm P Heavy Soil	Wash items made from synthetic fabrics. Program setting: <ul style="list-style-type: none"> ■ Max. temperature: Extra Hot ■ Max. spin speed: High 	medium
Perm Press	Wash items made from cotton, linen, or synthetic fabrics. Suitable for lightly soiled laundry. Program setting: <ul style="list-style-type: none"> ■ Max. temperature: Extra Hot ■ Max. spin speed: High 	medium

¹ Speed Perfect activated

² Washing not possible

Program	Description	Max. load
Delicates	<p>Wash delicate, washable items made from silk, viscose, or synthetic fabrics. Use a detergent that is suitable for delicates or silk.</p> <p>Note: Wash especially delicate items or items with hooks, eyelets or clips in a mesh laundry bag.</p> <p>Tip: Gently cleaning the laundry reduces abrasion of textile fibers and microplastic fibers.</p> <p>Program setting:</p> <ul style="list-style-type: none"> ■ Max. temperature: Hot ■ Max. spin speed: Mid 	small
Hand Wash/Wool	<p>Wash hand- or machine-washable items that are made from wool or contain wool.</p> <p>To prevent the laundry from shrinking, the drum moves the items very gently with long pauses.</p> <p>Use a detergent that is suitable for wool.</p> <p>Program setting:</p> <ul style="list-style-type: none"> ■ Max. temperature: Hot ■ Max. spin speed: Mid 	small
Drain	<p>Drains the water, e.g. when a program is canceled.</p> <p>Do not use fabric softener.</p>	–
Rinse/Spin	<p>Rinses and then spins the laundry, and then drains the water.</p> <p>Program setting: Max. spin speed: High</p>	–
Allergen	<p>Wash hard-wearing items made from cotton or linen.</p> <p>Suitable for allergy-sufferers and for strict hygiene requirements.</p> <p>Note: Once the set temperature has been reached, it remains constant throughout the washing process.</p> <p>Program setting:</p> <ul style="list-style-type: none"> ■ Max. temperature: Extra Hot ■ Max. spin speed: High 	large
Towels	<p>Wash hard-wearing items made from cotton, e.g. towels and bathrobes.</p> <p>Program setting:</p> <ul style="list-style-type: none"> ■ Max. temperature: Extra Hot ■ Max. spin speed: High 	medium
Jeans	<p>Wash dark-colored and color-intense items made from cotton or permanent press fabric, e.g. jeans.</p> <p>Turn laundry inside-out before washing.</p> <p>Use liquid detergent.</p> <p>Program setting:</p> <ul style="list-style-type: none"> ■ Max. temperature: Hot ■ Max. spin speed: High 	medium
Drum Clean	<p>Clean and care for the drum. → <i>Page 25</i></p> <p>Use this program in the following cases:</p> <ul style="list-style-type: none"> ■ Before using the appliance for the first time ■ If you regularly wash at temperatures of Hot or lower ■ After an extended period of non-use <p>Use washing powder containing oxygen bleach. Add the washing powder containing oxygen bleach to compartment II for the main wash. → <i>Page 14</i></p> <p>Halve the amount of detergent to avoid foaming.</p> <p>Do not use fabric softener.</p> <p>Do not use liquid detergent or detergent that is intended for woolens or delicates.</p>	– ²

¹ **Speed Perfect** activated

² Washing not possible

Program	Description	Max. load
Quick 30	Wash items made from cotton or synthetic fabrics. Short program for small items of lightly soiled laundry. Program setting: <ul style="list-style-type: none"> ■ Max. temperature: Hot ■ Max. spin speed: High 	medium
Perm P Light Soil	Wash items made from cotton or synthetic fabrics. Short program for small items of lightly soiled laundry. Program setting: <ul style="list-style-type: none"> ■ Max. temperature: Hot ■ Max. spin speed: High 	medium
¹ Speed Perfect activated ² Washing not possible		

10 Accessories

Only use original accessories. These are designed especially for your appliance.

Tip: Some accessories are available in other colors. Contact customer service. → *Page 34*

	Use	Order number
Water outlet hose extension	Extend the water outlet hose (2.20 m/86.6 in).	11057910
Fixing brackets	Improves the stability of the appliance.	WMZ2200
Liquid detergent insert	Measure liquid detergent.	00605740
Platform	Install the appliance at a raised height so that it can be easily loaded and unloaded.	WMZPW20W
Washing machine cleaners	Cleaning product for maintaining the appliance interior.	00311928
Power adapter	Connect the appliance to a NEMA 14-30 (4-pin) outlet.	WTZPA20UC
Power adapter	Connect the appliance to a NEMA 10-30 (3-pin) outlet.	WTZPA30US

11 Laundry

11.1 Preparing the laundry

NOTICE:

Objects remaining in the laundry may damage the laundry and the drum.

- ▶ Remove all items from any pockets in your laundry before using the appliance.

Note

The appliance and fabrics are protected when you prepare your laundry.

- Brush off sand and soil
- Sort the laundry according to color and fabrics and observe the care labels
- Close all zippers, hook and loop fasteners, hooks and eyes
- Tie cloth belts, cloth straps and cords together
- Remove curtain fittings and lead strips
- Wash small or particularly delicate items in a mesh washing bag
- Wash large and small items of laundry together
- Wash laundry with fresh stains immediately
- Pretreat laundry with dried stains and wash several times
- Load the laundry unfolded into the drum
- Before loading the drum, any laundry that has been pretreated with chlorine bleach should be rinsed several times

12 Detergents and care products

You can protect your appliance and your laundry by selecting and using the correct detergents and care products.

The manufacturer's instructions for use and dosage can be found on the packaging.

Notes

- when using liquid detergents, only use liquid detergents that are self-flowing
- Do not mix different liquid detergents
- Do not mix detergent and fabric softener
- Do not use products that have expired or are highly congealed
- do not use products containing solvents, caustic agents or volatile substances
- Do not use chlorine bleach
- Do not use dyes regularly as fixing salt can damage stainless steel
- Do not use color-bleaching agents in the appliance

13 Basic Operation

13.1 Switching on the appliance

Requirement: The appliance has been correctly installed and connected. → *Page 7*

- ▶ Turn the program selector to a program.

13.2 Setting a program

1. Turn the program selector and set the required program.
→ *"Programs", Page 19*
2. If required, adjust the program settings.
→ *"Buttons", Page 18*

The program settings are not saved permanently for the program.

13.3 Opening the door

1. Grip under the door handle and pull on the door.

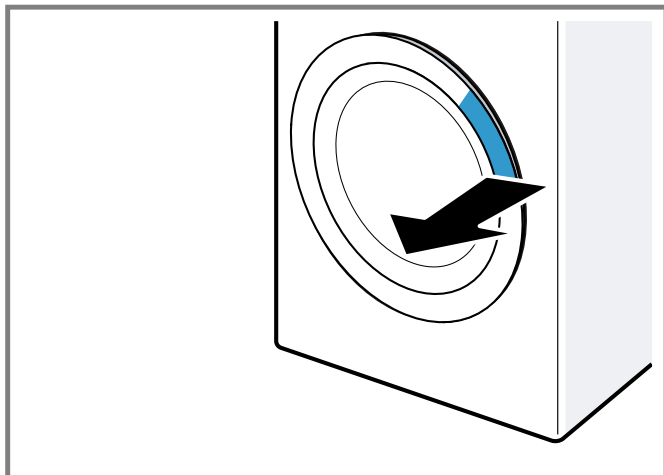

2. Open the door.

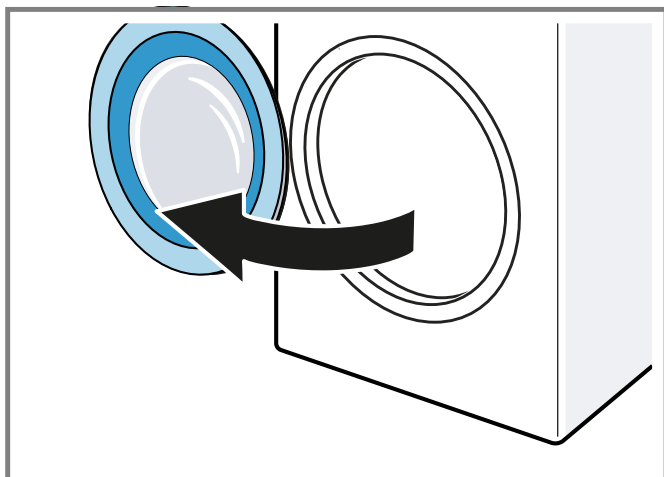

13.4 Loading laundry

Note: To prevent creasing, note the maximum load for the programs.

→ "Programs", Page 19

Requirements

- The laundry is prepared and sorted.
→ "Laundry", Page 22
- The drum is empty.

1. Open the door. → Page 23
2. Place the laundry in the drum.
3. Close the door.

Ensure that there is no laundry trapped in the door.

13.5 Inserting the measuring aid

1. Pull out the detergent drawer.

2. Press down on the insert and remove the detergent drawer.

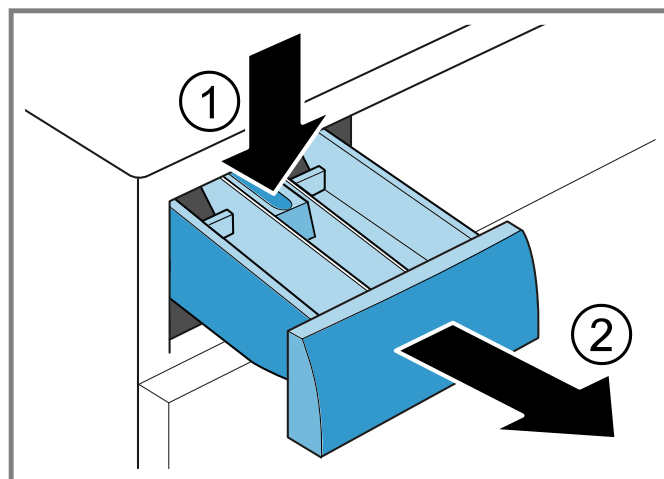

3. Insert the measuring aid.

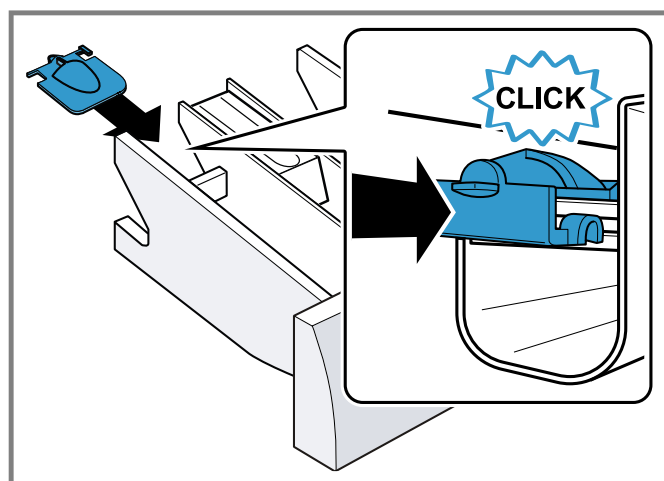

13.6 Using the measuring aid

To more easily measure the liquid detergent, you can use a measuring aid in the detergent drawer.

Note: Do not use a measuring aid for viscous detergents, for washing powder, or when the prewash or program end time is activated.

Requirements

- The detergent drawer → Page 14 has been pulled out.
- The measuring aid is inserted. → Page 23

1. Slide the measuring aid forwards.

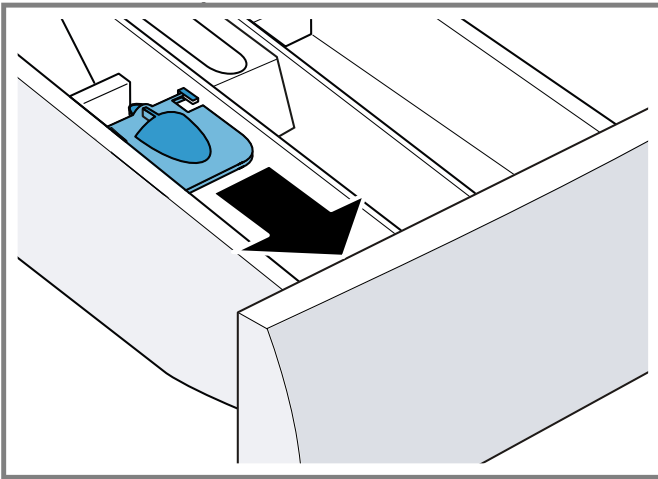

2. Fold the measuring aid down and click it into place.

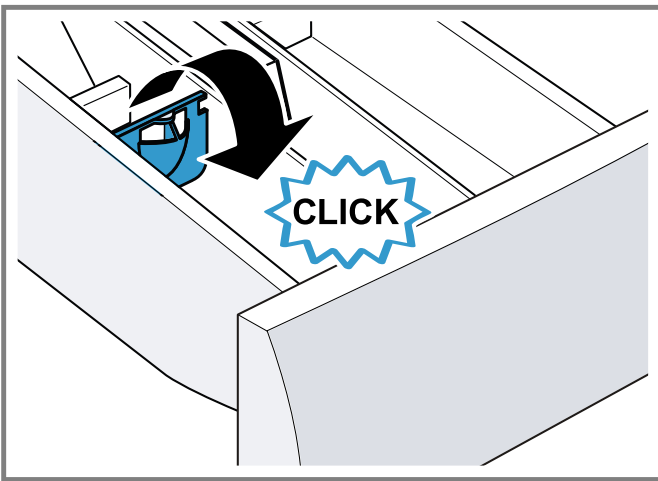

13.7 Adding detergent and care product

Note: Observe the information about detergents and care products → *Page 22*.

1. Pull out the detergent drawer.
2. If required, use the dosing aid. → *Page 23*
3. Pour in the detergent.
→ *"Detergent drawer", Page 14*
4. If required, add the care product.
5. Push in the detergent drawer.

13.8 Starting the program

Requirement: A program has been set. → *Page 22*

- ▶ Press **Start Pause**.
- ✓ The display shows the program duration or the program end time.
- ✓ After the program has ended, the display shows: **End**.

13.9 Soaking laundry

Note: No additional detergent is required for soaking. The appliance uses the filled detergent for soaking and washing.

Requirements

- The laundry is placed in the appliance. → *Page 23*
 - A program has started. → *Page 24*
1. Press **Start Pause** approx. 10 minutes after the program start.
The program pauses and the laundry can soak.
 2. Press **Start Pause** after the required soaking time.

13.10 Adding laundry

After the program starts, you can remove or add laundry depending on the program status.

1. Press **Start Pause**.

The appliance pauses.

Note: If you want to add laundry, follow the instructions on the display.

→ *"Display", Page 16*

2. Open the door. → *Page 23*
3. Add or remove laundry.
4. Close the door.
5. Press **Start Pause**.

13.11 Terminating the program

1. Press **Start Pause**.

2. Open the door. → *Page 23*

The appliance door remains locked for safety reasons if the temperature and water levels are high.

- If the temperature is high, start the **Rinse** program.
- If the water level is high, start the **Spin** program or select a suitable program for draining.

→ *"Programs", Page 19*

3. Remove the laundry. → *Page 24*

13.12 Removing the laundry

1. Open the door. → *Page 23*
2. Remove the laundry from the drum.

13.13 Switching off the appliance

1. Turn the program selector to **Off**.
2. Turn off the tap.
3. Cleaning the rubber gasket. → *Page 29*

Note: Leave the appliance door and the detergent drawer open to dry.

14 Control panel lock

Secure your appliance against being operated unintentionally using the controls.



14.1 Activating the control panel lock

- ▶ Press on both **3 Sec.** buttons for approx. three seconds.

- ✓ The display shows .
- ✓ The control elements are locked.
- ✓ The control panel lock remains active even after the appliance has been switched off and in the event of a power failure.

14.2 Deactivating the control panel lock

Requirement: To deactivate the control panel lock, the appliance must be switched on.

- ▶ Press on both  **3 Sec.** buttons for approx. three seconds.
- ✓  goes out on the display.

15 Basic settings

You can configure the basic settings for your appliance to meet your needs.

15.1 Overview of the basic settings

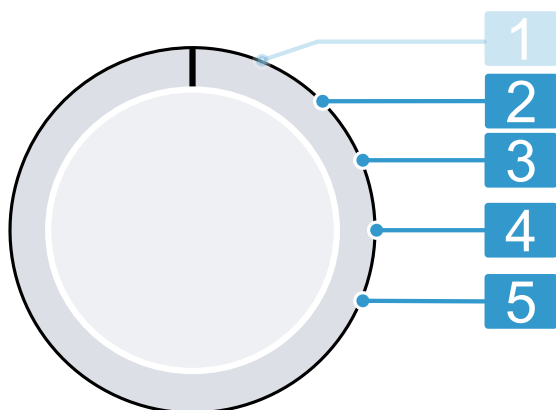

Program selector with program positions

- | | |
|----------|--|
| 2 | Set the volume of the signal tone that is emitted when the program ends:
0 (off) to 4 (very loud) |
| 3 | Set the volume of the signal tone that is emitted when the buttons are selected:
0 (off) to 4 (very loud) |
| 4 | No basic setting. |
| 5 | Display the number of finished programs. |

15.2 Changing the basic settings

1. Set the program selector to position 1. → *Page 25*
2. Press **Start Pause** and, at the same time, turn the program selector to position 2.
- ✓ The display shows the current value.
3. Use the program selector to select the required basic setting. → *Page 25*
4. Press **Finish in** to change the value.

5. To save the changes, switch off the appliance.

16 Cleaning and maintenance

To keep your appliance working efficiently for a long time, it is important to clean and maintain it carefully.

16.1 Cleaning the drum

Clean the drum if you have carried out 20 washing cycles at a temperature of Hot or lower, or if you have not used the appliance for a prolonged period, but at least once a year.

CAUTION

Permanently washing at low temperatures and a lack of ventilation for the appliance may damage the drum and cause injury.

- ▶ Regularly run a program for cleaning the drum or wash at temperatures of Extra Hot.
- ▶ Leave the appliance to dry after every operation with the door open, and leave the detergent drawer to dry.
- ▶ Run the **Drum Clean** program without laundry but with washing powder that contains oxygen bleach or a cleaning agent for caring for the inside of the appliance.

16.2 Cleaning the detergent drawer

1. Pull out the detergent drawer.
2. Press down on the insert and remove the detergent drawer.

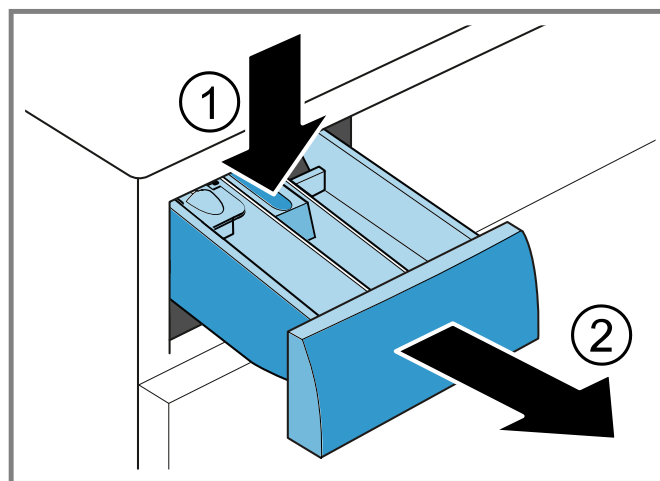

3. Pull out the insert upwards.

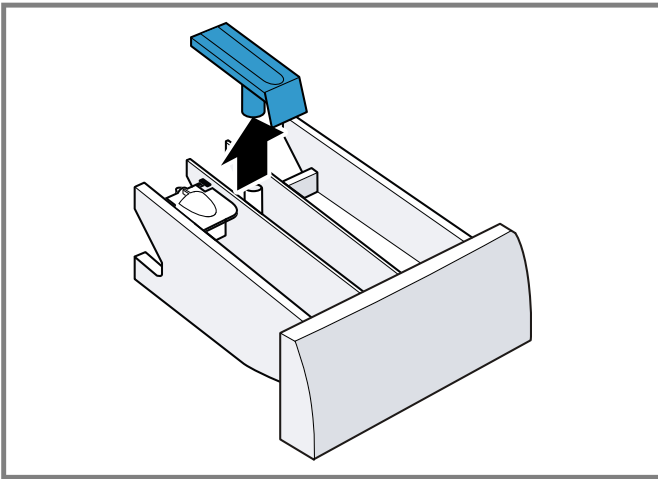

4. Clean the detergent drawer and insert with water and a brush, and then dry them.

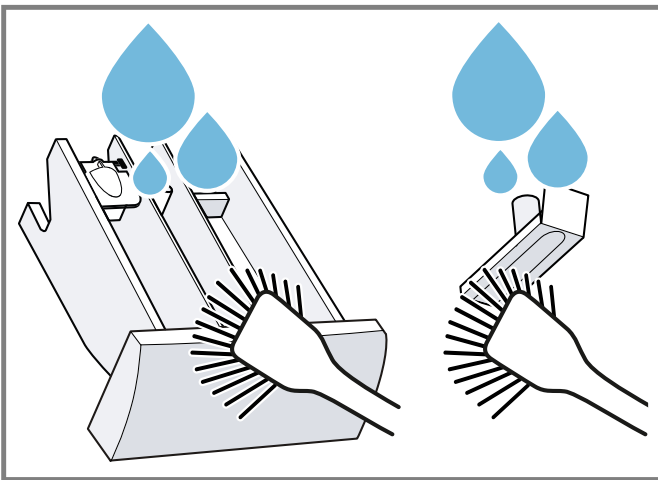

5. Fit the insert and click it into place.

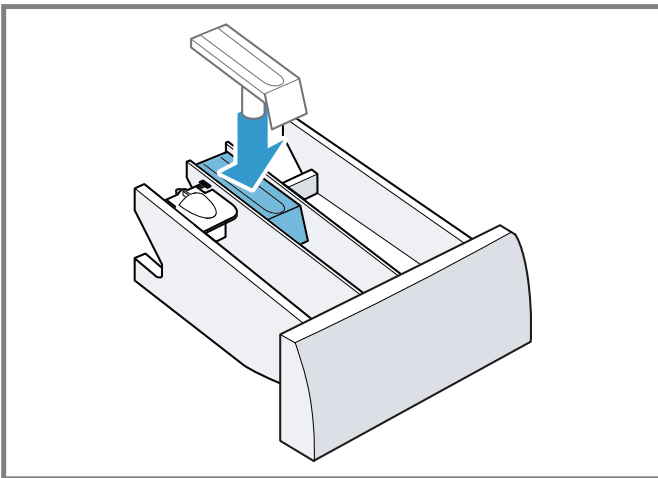

6. Clean the opening for the detergent drawer.

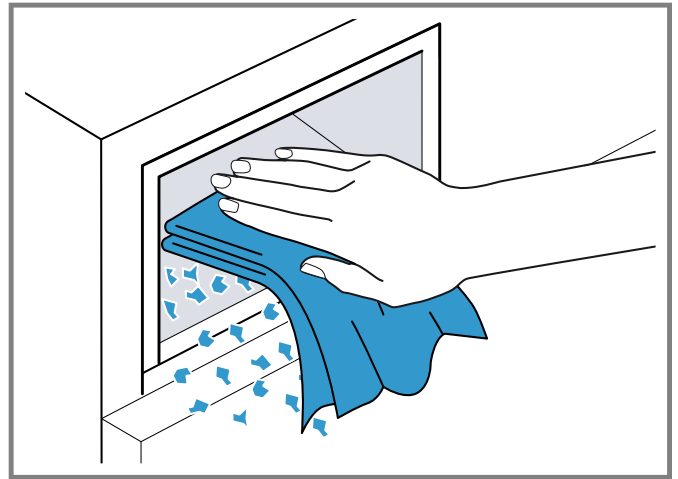

7. Push in the detergent drawer.



16.3 Cleaning the drain pump

Clean the drain pump regularly, at least once a year, as well as in the event of faults, e.g. blockages or rattling noises.

Emptying the drain pump

1. Turn off the faucet.
2. Switch off the appliance. → *Page 24*
3. Disconnect the appliance's mains plug from the power supply.
4. Open and remove the service flap.

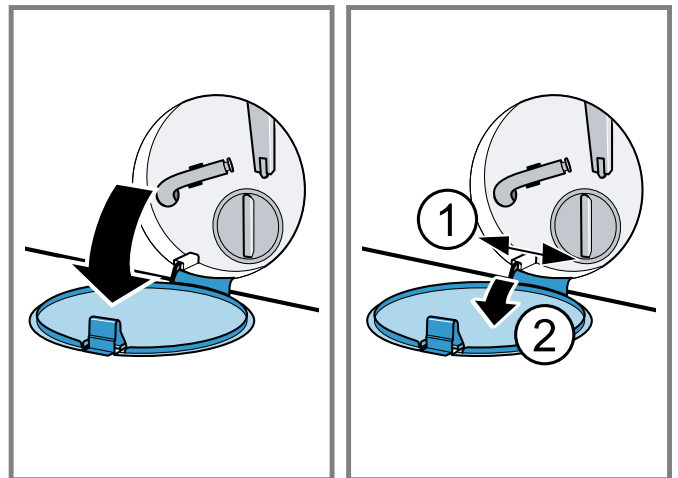

5. Loosen the screws and remove the protective film.

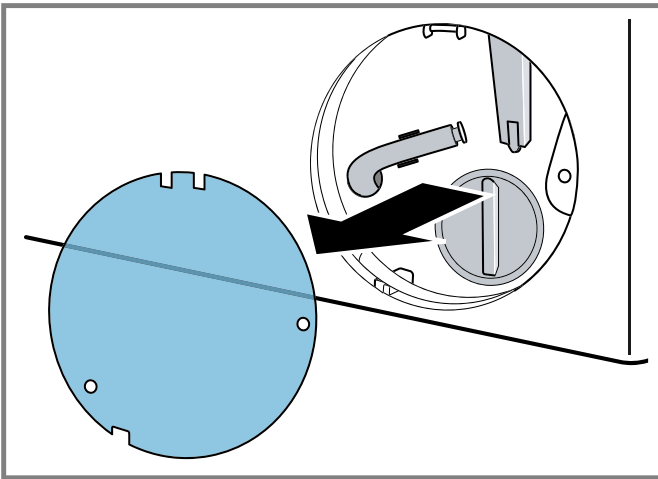
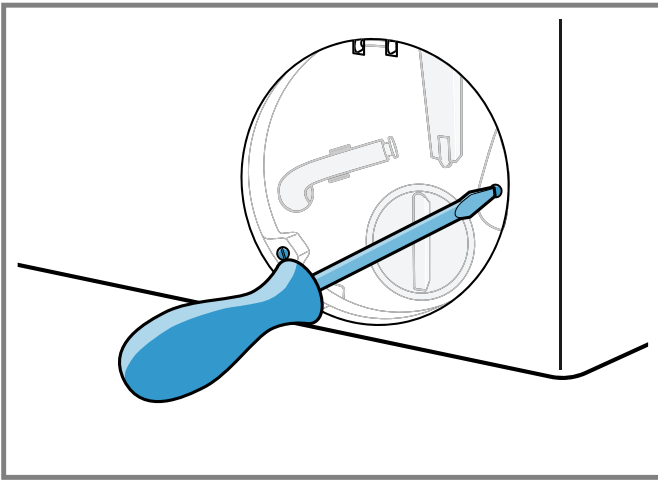

6. Slide a suitable receptacle under the opening for draining the detergent solution.

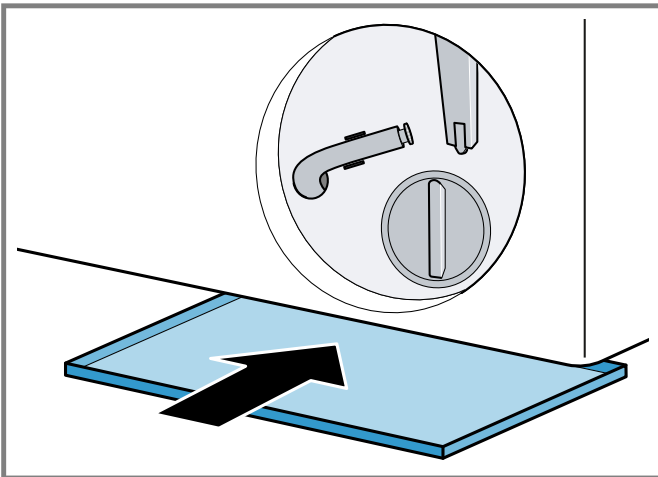

7. Take the drain hose out of the holder.

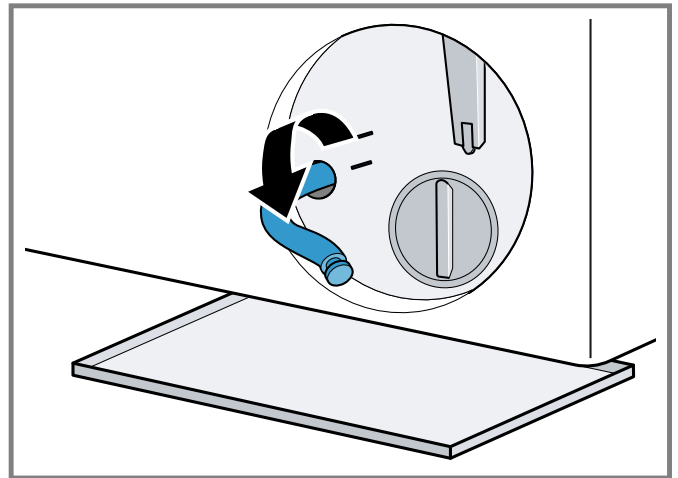

8. **⚠ CAUTION** When you wash at high temperatures, the detergent solution becomes hot.
 ▶ Do not touch the hot detergent solution.
 To allow the detergent solution to flow out into the container, remove the sealing cap.

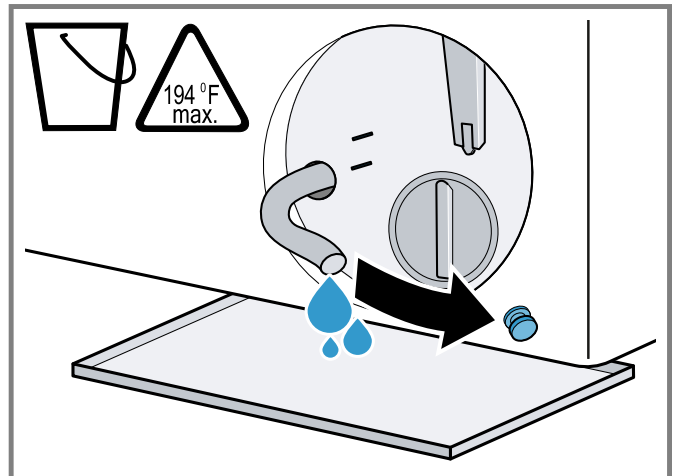

9. Once emptied, press firmly on the locking cap.

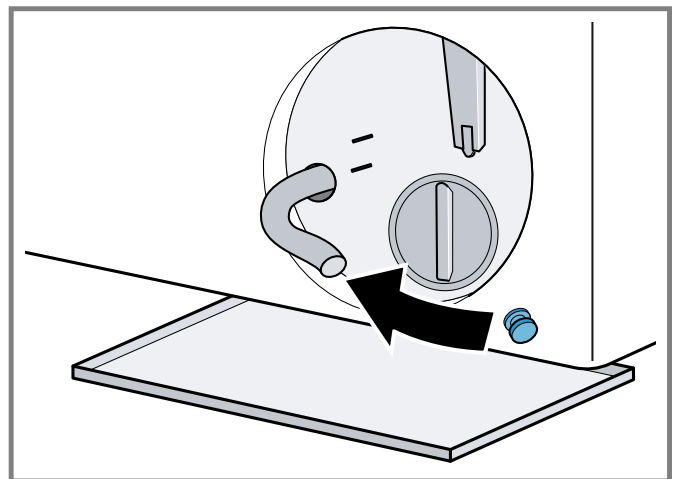

10. Clip the drain hose into the holder.

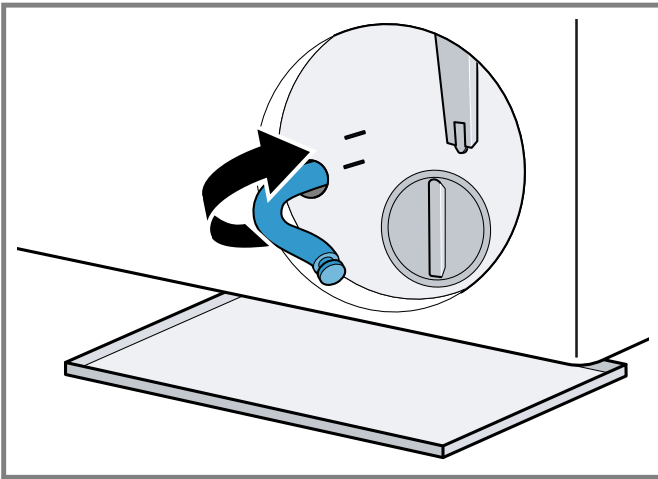

Cleaning the drain pump

Requirement: The drain pump is empty. → Page 26

1. Since water may remain in the drain pump, unscrew the pump cap carefully.
 - The filter insert in the pump housing may become stuck due to coarse particles of dirt. Loosen the dirt and remove the filter insert.

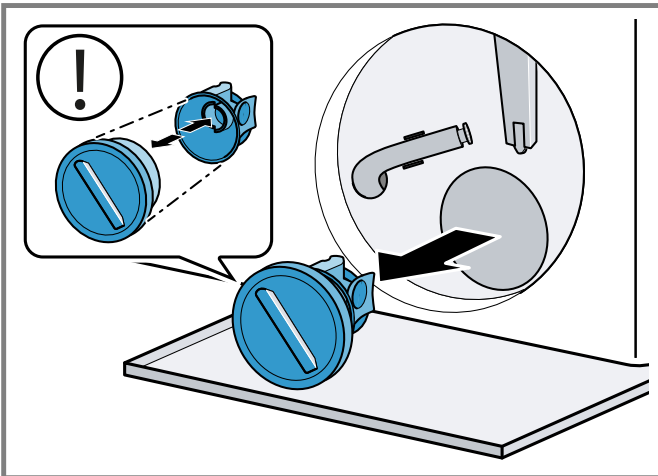

The pump cap is comprised of two parts which can be taken apart for cleaning.

2. Clean the interior, the thread on the pump cap and the pump housing.

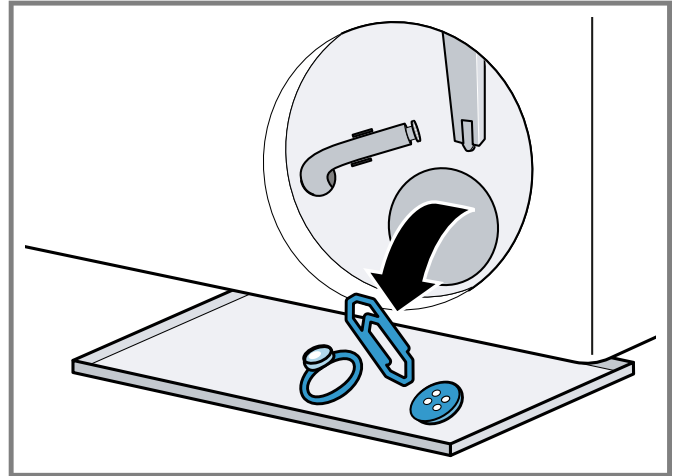

3. Ensure that the impeller in the drain pump can rotate.
4. Insert the pump cap.
 - Ensure that the parts of the pump cap are correctly assembled.

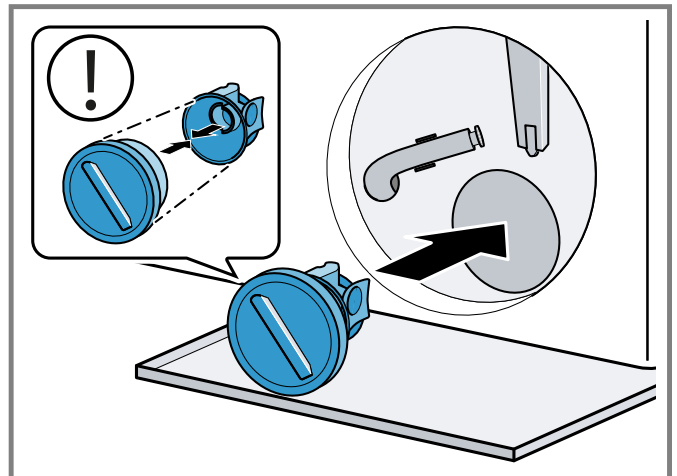

5. Screw the pump cap as far as it will go.

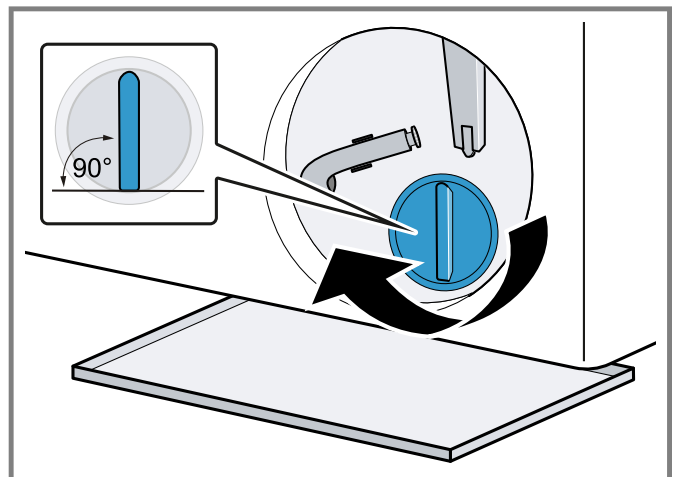

The handle on the pump cap must be in a vertical position.

6. Fit the protective film and secure with the screws.

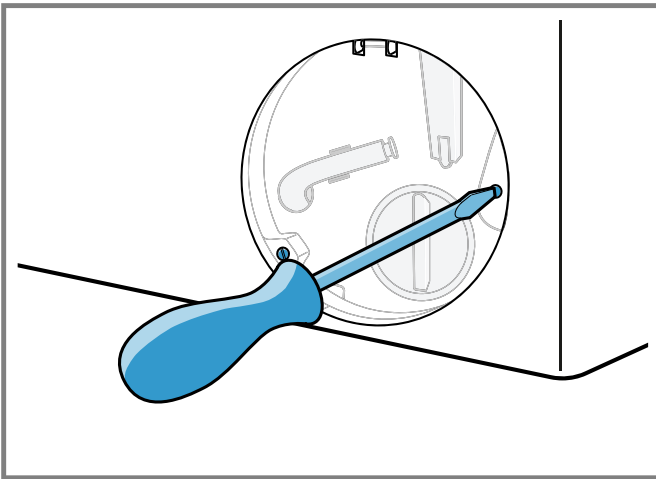
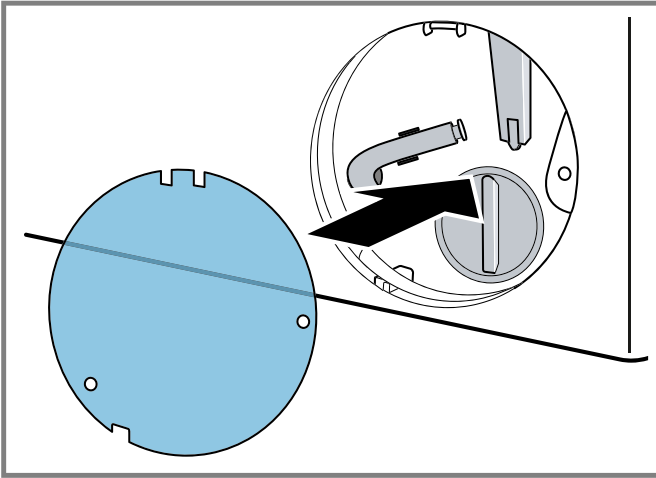

7. Insert and close the service flap.

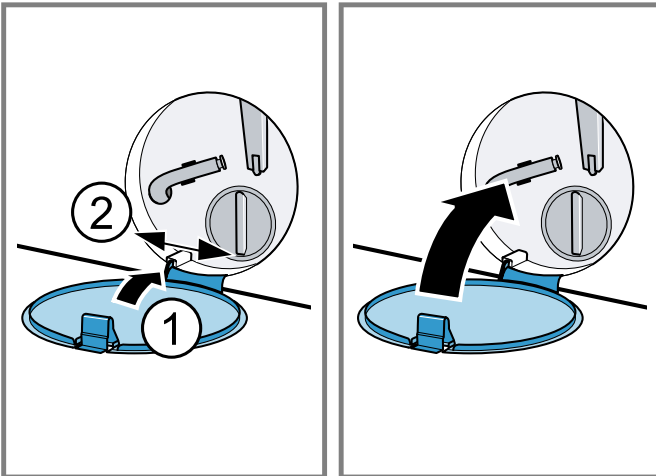

Before the next wash

To prevent unused detergent from flowing straight into the outlet in the next wash, run a suitable program for draining after you have emptied the drain pump.

1. Turn the faucet on.
2. Insert the mains plug.
3. Switch on the appliance.
4. Pour 1 US quart (1 liter) of water into compartment II.
5. Select a suitable program for draining.
→ "Programs", Page 19

16.4 Cleaning the rubber gasket

Clean the rubber gasket regularly.

1. Open the door. → Page 23
2. Remove any foreign objects and fluff from the rubber gasket.

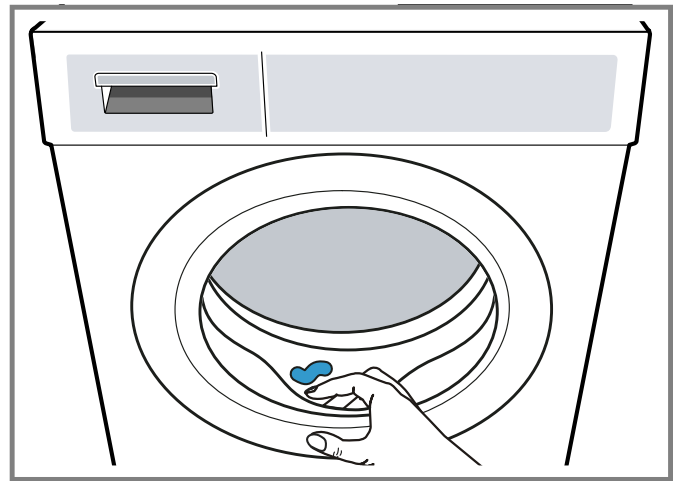

3. Clean the outside and the inside of the rubber gasket with a damp cloth and wipe dry.



17 Troubleshooting

You can eliminate minor issues on your appliance yourself. Please read the information on eliminating issues before contacting Customer Service. This may avoid unnecessary repair costs.



WARNING

Improper repairs are dangerous.

- ▶ Never make any technical modifications to the appliance or its features.

- ▶ Do not tamper with controls.
- ▶ Repairs to the appliance should only be performed by authorized service providers.
- ▶ Only original spare parts may be used to repair the appliance.
- ▶ If the power cord of this appliance becomes damaged, it must be replaced by the manufacturer, the manufacturer's Customer Service, or an authorized service provider in order to prevent injury.

Issue	Cause and troubleshooting
The display goes out and Start Pause flashes.	Energy-saving mode is active. ▶ Press Start Pause .
E:36 -10 / E:30 -80 / E:18 The detergent solution is not being pumped out.	The water outlet hose is connected too high, is kinked or trapped, or has been extended impermissibly. ▶ Check the installation of the water outlet hose. → <i>Page 11</i> Drain pipe or water outlet hose is blocked. ▶ Clean the drain pipe and the water outlet hose. The drain pump is blocked or the pump cover is not installed correctly. ▶ Check that the pump cover is installed correctly. → <i>Page 26</i> ▶ Clean the drain pump. → <i>Page 26</i> Detergent dosage is too high. ▶ Reduce the amount of detergent for the next washing cycle with the same load.
E:60 -2B / E:32 / H:32	The appliance has interrupted the spin cycle because the laundry is unevenly distributed. ▶ Redistribute the laundry in the drum.
E:30 -10 / E:92 -01 / 	Faucet is turned off. ▶ Turn on the faucet. The water inlet hose is kinked or jammed. ▶ Check the installation of the water inlet hose. → <i>Page 11</i> The filters in the water inlet are blocked. ▶ Clean the filters in the water inflow. The water pressure is low. ▶ Check whether the faucet has sufficient water pressure. The water level measuring system is defective. With this fault message, the appliance starts a draining process. 1. Wait approx. 5 minutes until the draining process ends. 2. Restart the appliance. If required, start the draining process again. 3. If the fault persists, call customer service. → <i>Page 34</i>
E:30 -20	Critical malfunction. ▶ Turn off the faucet. With this fault message, the appliance starts a draining process. 1. Wait approx. 5 minutes until the draining process ends. 2. Restart the appliance. If required, start the draining process again. 3. If the fault persists, call customer service. → <i>Page 34</i> Detergent dosage is too high. ▶ Reduce the amount of detergent for the next washing cycle with the same load.

Issue	Cause and troubleshooting
E:30 -20	Additional water has been added. ▶ Do not add any extra water to the appliance while it is operating.
All other fault codes.	Operational fault 1. Restart the appliance. 2. If the fault occurs again, disconnect the appliance from the power supply for at least 30 seconds. Unplug the power plug or switch off the circuit breaker in the fuse box. 3. If the fault persists, call customer service. → <i>Page 34</i> Please specify the exact error message when calling. If possible, document the fault with photos and videos.
 or heavy foam build-up.	Detergent dosage is too high. ▶ Mix one tablespoon of fabric softener with 2.1 cups (0.5 l) of water and pour the mixture into compartment II (not for outdoor clothing, sportswear, or items stuffed with down). ▶ Reduce the amount of detergent for the next washing cycle with the same load.
 flashes.	The door is not completely closed. 1. Ensure that there is no laundry trapped in the door. 2. Close the door.
The program does not start.	The control panel lock is activated. ▶ Deactivate the control panel lock. → <i>Page 25</i> <hr/> Finish in is activated. ▶ Check whether Finish in is activated. → <i>Page 18</i>
The program is paused or has been interrupted, but the door will not open.	Temperature is too high. ▶ Start the Rinse program or wait until the temperature has dropped. <hr/> Water level is too high. ▶ Start the Spin program or a suitable draining program. → <i>Page 19</i>
The door cannot be opened due to a power outage.	The door is locked. ▶ Open the door using the emergency release. → <i>Page 32</i>
Drum jerks after the program starts.	Not a fault. An internal motor test is started. No action required.
There is no water visible in the drum.	Not a fault. Water is below the visible area. No action required.
Drum starts rotating briefly several times.	Not a fault. The appliance eliminates an imbalance by repeatedly redistributing the laundry. No action required.
The appliance is vibrating, 'wandering', and making loud noises during the spin cycle.	Appliance is not correctly aligned. ▶ Align the appliance. → <i>Page 12</i> <hr/> The appliance feet are not fixed. ▶ Secure the appliance's feet. → <i>Page 12</i> <hr/> Transit bolts have not been removed. ▶ Remove the transit bolts.
High spin speed not reached.	The appliance is using a reduced spin speed to eliminate an imbalance. No action required.
The program duration changes during the wash cycle.	Not a fault. The program sequence is optimized electronically, another rinse cycle is switched on due to heavy foam build-up, or an imbalance is eliminated. No action required.
Whooshing, hissing, or sucking noises.	Not a fault. Water is pumped in or detergent solution is pumped out. No action required.

Issue	Cause and troubleshooting
Banging noises, rattling in the drain pump.	A foreign object is in the drain pump. ▶ Clean the drain pump. → <i>Page 26</i>
There are detergent residues on the laundry.	Detergents may contain water-insoluble substances that deposit on the laundry. ▶ Start the Rinse program or brush out the laundry after drying.
The laundry is too wet after the spinning cycle.	A low spin speed is selected. ▶ Start the Spin program. ▶ The next time you run a wash cycle, set a higher spin speed. The appliance is using a reduced spin speed to eliminate an imbalance. 1. Redistribute the laundry in the drum. 2. Start the Spin program.
Creasing.	The selected program is unsuitable for the type of fabric. ▶ Set a suitable program. → <i>Page 19</i>
	A high spin speed is selected. ▶ The next time you run a wash cycle, set a lower spin speed.
	The load is unsuitable. ▶ Observe the program's maximum load capacity. → <i>Page 19</i> ▶ Prepare the laundry. → <i>Page 22</i>
Water is leaking out at the water inlet hose.	The water inlet hose is not correctly connected or is damaged. ▶ Check the installation of the water inlet hose. → <i>Page 7</i> Replace the water inlet hose if it is damaged.
Water is leaking out at the water outlet hose.	The water outlet hose is not connected correctly or is damaged. ▶ Check the installation of the water outlet hose. → <i>Page 7</i> Replace the water outlet hose if it is damaged.
Water is leaking from below the door.	Dirt on the door or seal causes leaks. ▶ Clean the door and the seal.
Detergent or fabric softener drips off the seal and collects on the door or in the seal fold.	There is too much detergent or fabric softener in the detergent drawer. ▶ When dosing, observe the marking in the detergent drawer. → <i>Page 24</i>
Residual water is present in the compartment ☼.	Insert in compartment ☼ is blocked. ▶ Clean the detergent drawer. → <i>Page 25</i>
Fabric softener remains in the detergent drawer.	The use of fabric softener is not supported for the selected program. ▶ Check whether the use of fabric softener is supported for the selected program. → <i>Page 19</i>
Odors have formed in the appliance.	Humidity and detergent residue may promote the formation of bacteria. ▶ Clean the drum. → <i>Page 25</i> ▶ If you are not using the appliance, leave the door and detergent drawer open so that residual water can evaporate.

17.1 Emergency release

Releasing the door

Requirement: The drain pump is empty. → *Page 26*

1. **NOTICE:** Escaping water may cause material damage.
 - ▶ Do not open the door if you can see water through the glass.

Pull the emergency release downwards with a tool and release.

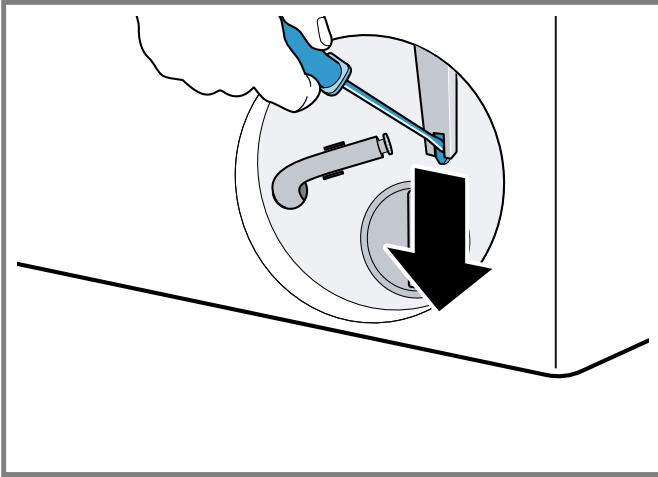

- ✓ The door lock is released.

17.2 Restart the appliance.

1. Restart the appliance.
2. If the fault occurs again, disconnect the appliance from the power supply for at least 30 seconds.
 - Unplug the power plug or switch off the circuit breaker in the fuse box.
3. If the fault persists, call customer service. → *Page 34*
 - Please specify the exact error message when calling. If possible, document the fault with photos and videos.

18 Transportation, storage and disposal

18.1 Removing the appliance

1. Turn off the faucet.
2. Empty the water inlet hose.
3. Switch off the appliance. → *Page 24*
4. Unplug the appliance's mains plug.
5. Drain the water.
 - *"Cleaning the drain pump", Page 26*
6. Detach the hoses.

2. Insert the service flap and lock it into place.
3. Close the service flap.

18.2 Inserting the transit bolts

Secure the appliance before transportation using transit bolts in order to prevent transport damage.

1. Use a screwdriver to remove the cover caps¹.

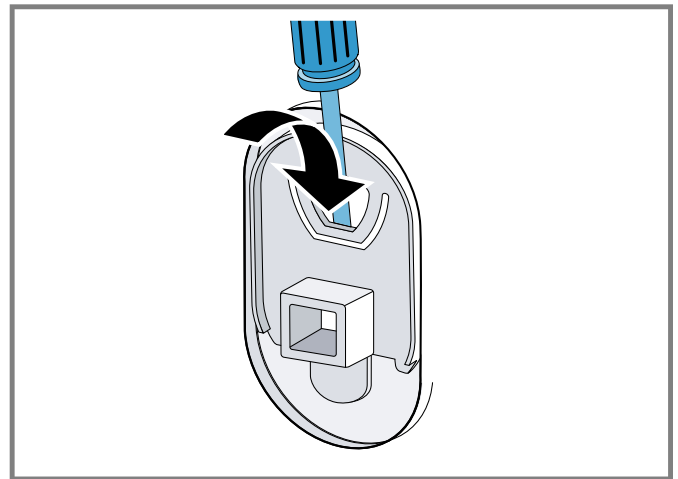

Retain the cover cap.

2. Insert the 4 transit bolts.

18.3 Using the appliance again

- ▶ For further information, see
 - *"Installation and connection", Page 7* and
 - *"Starting an empty washing cycle", Page 12.*

¹ The number of cover caps varies depending on the model.

18.4 Disposal of your old appliance

Environmentally compatible disposal allows valuable raw materials to be recycled.

⚠ WARNING

Children can lock themselves in the appliance, thereby putting their lives at risk.

- ▶ Do not install the appliance behind a door as this may obstruct the appliance door or prevent it from opening.
- ▶ With redundant appliances, pull out the mains plug of the power cord, cut through the power cord and remove the appliance door.

1. Unplug the appliance from the power supply.
2. Cut through the power cord.
3. Remove the appliance door.
4. Dispose of the appliance in an environmentally responsible manner.

Information about current disposal methods can be obtained from your specialist dealer or local authority.

19 Customer Service

With any warranty repair, we will make sure your appliance is repaired by an authorized service provider using genuine replacement parts. We use only genuine replacement parts for all repairs.

Detailed information on the warranty period and terms of warranty can be found in the Statement of Limited Product Warranty, from your retailer, or on our website.

If you contact Customer Service, you will need the model number (E-Nr.) and the production number (FD) of your appliance.

USA:

1-800-944-2904

www.bosch-home.com/us/owner-support/get-support

www.bosch-home.com/us/shop

CA:

1-800-944-2904

www.bosch-home.ca/en/service/get-support

www.bosch-home.ca/en/service/cleaners-and-accessories

19.1 Model number (E-Nr.) and production number (FD)

You can find the model number (E-Nr.) and the production number (FD) on the appliance's rating plate.

Depending on the model, the rating plate can be found:

- on the inside of the door.
- on the inside of the service flap.
- on the backside of the appliance.

Making a note of your appliance's details and the Customer Service telephone number will enable you to find them again quickly.

20 Technical specifications

Weight	157.4 lbs (71.4 kg)
Drum volume	2.2 ft ³
Mains voltage	208-240 V, 60 Hz
⇌ Minimum installation protection	10,5 A
Power rating	2300 W
Water pressure	<ul style="list-style-type: none"> ■ Minimum: 14.5 psi (100 kPa) ■ Maximum: 145 psi (1000 kPa)
Ambient temperature	<ul style="list-style-type: none"> ■ Minimum: 41 °F (5 °C) ■ Maximum: 95 °F (35 °C)
Relative humidity	< 95 %
Length of the water inlet hose	47" (119.4 cm)
Length of the water drain hose	57" (144.8 cm)
Length of the power cord	64 7/8" (165 cm)

Appliance dimensions

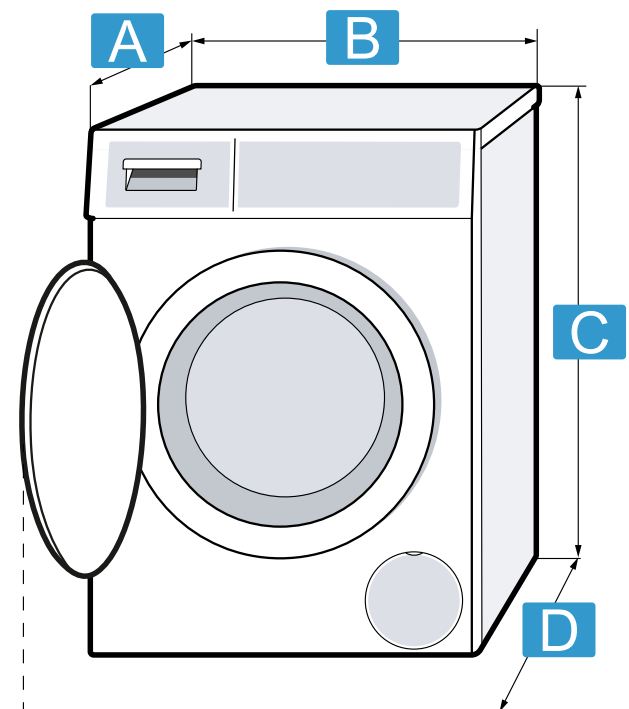

A	Appliance depth: 25" (59.0 cm) Appliance depth with door closed: 23 1/4" (63.2 cm)
B	Appliance width: 23 1/2" (59.8 cm)
C	Appliance height ¹ : 33 1/3" (84.8 cm)
D	Appliance depth with door open: 42" (106.3 cm)

¹ When aligning the appliance, the appliance height may increase by up to 1/2" (1.2 cm).



A series of horizontal lines for writing, spanning the width of the page. The lines are evenly spaced and cover most of the page area, starting from the top right of the pencil icon and extending to the bottom.



Register your appliance to enjoy customized benefits.

Thank you for being a Bosch customer!
Simply create a MyBosch account, then register your appliance.
You'll find a variety of customized information in MyBosch such as:

- **Discounts for filters, cleaners, accessories & parts**
- **Easy access to manuals & appliance specifications**
- **Easy access to part lists**
- **Customized offer for the Bosch Appliance Service Plan (sent by mail after appliance registration)**

Register here:
www.bosch-home.com/us/owner-support/mybosch

BOSCH
HOME APPLIANCES
SERVICE

Looking for help? You'll find it here.

No matter what, no matter when: Bosch is here to support you.
We're here to assist with usage instructions, cleaning tips,
accessories & parts, troubleshooting, and repairs.
Find online resources such as FAQs, how-to-videos, manuals,
warranties and authorized Bosch servicers at:
www.bosch-home.com/us/owner-support/get-support

Contact us:
Please have your Model Number (E-Nr) ready when contacting us.
1-800-944-2904
www.bosch-home.com/us/owner-support/contact-us

BSH Home Appliances Corporation
1901 Main Street, Suite 600
Irvine, CA 92614
USA
www.bosch-home.com
1-800-944-2904
© 2024 BSH Home Appliances Corporation



9001914040 (050127)

en-us