

36" Standard-Depth 3-Door Refrigerator

500 Series – Black Stainless Steel B36FD50SNB



BOSCH
Invented for life



B36FD50SNB
Black Stainless Steel

Also available in:

Stainless Steel
B36FD50SNS

Introducing the QuickIcePro System™, industry's fastest refrigerator ice maker.¹ Enjoy freshly filtered ice that's replenished fast.

Features & Benefits

The Bosch QuickIcePro System offers rapid ice replenishment, producing up to 12 lbs of ice per day,² ensuring ample ice availability.

UltraClarityPro™ water filter reduces >99.9% of sediment that may be found in your water and ice, including harsh elements like chlorine and chloramine.

With Home Connect™, remotely control and monitor your appliance to efficiently manage your day.

General Properties	
Full 69" height and standard depth for additional capacity	Yes
Easy Clean Stainless Steel	Yes
Lighting	Recessed LED light bars
Number of evaporators	1
Defrost process refrigerator section	Frost-free
Number of shelves – refrigerator	5
Adjustable shelves – refrigerator	4 half-width
Shelf material – refrigerator	Tempered glass
Type of shelves – refrigerator	Frameless split shelves with chromed trim
Ice maker	Yes
Water filter	UltraClarityPro™
External water and ice dispenser	Yes
Gallon storage bins	2
Humidity control compartments	2
Full width drawer	1
Touch control panel	Yes
AirFresh® filter	Yes
MultiAirFlow™	Yes
Stainless steel back wall	Yes
Defrost process freezer section	Automatic
Number of drawers – freezer	2
Home Connect™ (Wi-Fi enabled)	Yes

Capacity	
Total capacity	26.0 cu. ft.
Refrigerator capacity	18.0 cu. ft.
Freezer capacity	8.0 cu. ft.
Technical Details	
Current	15 A
Volts	115 V
Frequency	60 Hz
Power cord length	91"
Plug type	120V-3 prong
Dimensions & Weight	
Appliance dimensions with hinges, handles and doors (HxWxD)	70"* x 35 5/8" x 35 7/16"
Appliance dimensions without hinges and doors (HxWxD)	69 1/2"* x 35 5/8" x 28 3/8"
Appliance dimensions with hinges and doors, no handles (HxWxD)	70"* x 35 5/8" x 33 1/8"
Required cutout size (HxWxD)	70" x 36" x 29 5/16"
Net weight	320 lbs
Efficiency	
Energy consumption	702 kWh/yr
ENERGY STAR® qualified	Yes
Accessories	
UltraClarityPro™ Water Filter: BORPLFTR55 90 Degree Door Stopper: 10012733	



¹Based on single ice maker production rates during a 24-hour period, measured per IEC standard and manufacturer user's manuals, for brands identified in US and Canada TraQLine as freestanding French door bottom mount refrigerators. Results may vary depending on operating conditions.

²Based on filling 8 oz glasses.

*When leveling legs are fully extended, add 5/8" to overall height, total 70 5/8".

Accessories: To purchase Bosch accessories, cleaners & parts please visit www.bosch-home.com/us/store or call 1-800-944-2904 (Mon to Fri 5 am to 6 pm PST, Sat 6 am to 3 pm PST).

Notes: All height, width and depth dimensions are shown in inches. BSH reserves the absolute and unrestricted right to change product materials and specifications, at any time, without notice. Consult the product's installation instructions for final dimensional data and other details prior to making cutout.

Warranties: Please see Use & Care manual or Bosch website for statement of limited warranty.

For more information on our entire line of products, go to www.bosch-home.com/us or call 1-800-944-2904

© BSH Home Appliances Corporation. All rights reserved. Bosch is a registered trademark of Robert Bosch GmbH.

36" Standard-Depth 3-Door Refrigerator

500 Series – Black Stainless Steel B36FD50SNB



Installation Details

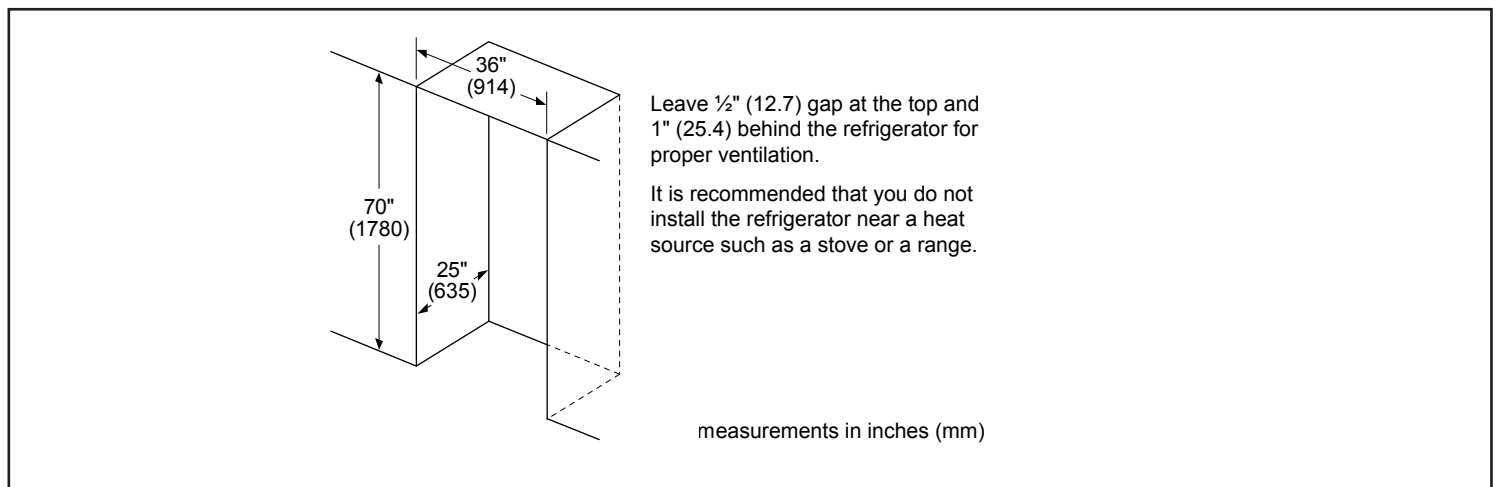
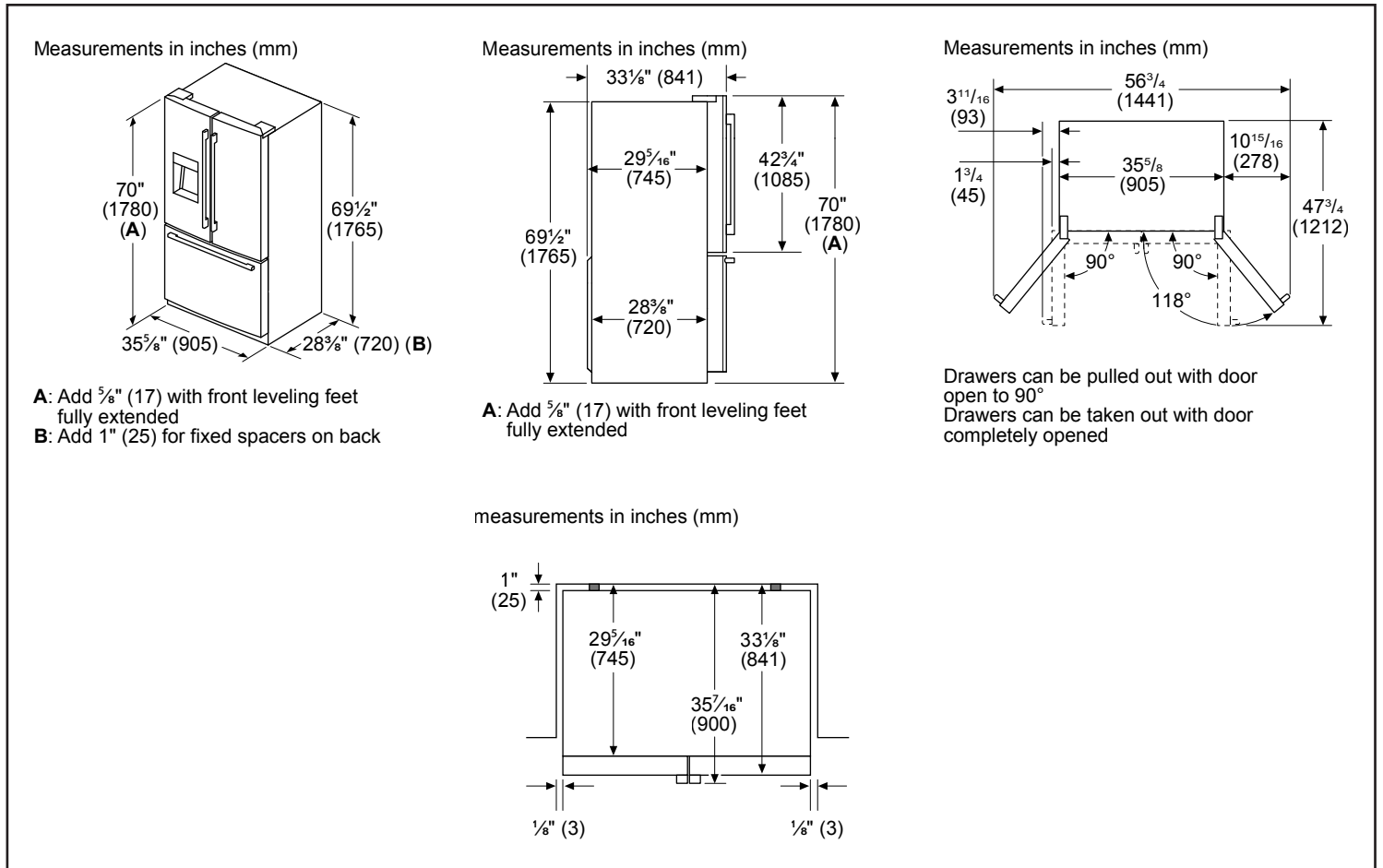

Accessories: To purchase Bosch accessories, cleaners & parts please visit www.bosch-home.com/us/store or call 1-800-944-2904 (Mon to Fri 5 am to 6 pm PST, Sat 6 am to 3 pm PST).

Notes: All height, width and depth dimensions are shown in inches. BSH reserves the absolute and unrestricted right to change product materials and specifications, at any time, without notice. Consult the product's installation instructions for final dimensional data and other details prior to making cutout.

Warranties: Please see Use & Care manual or Bosch website for statement of limited warranty.

For more information on our entire line of products, go to www.bosch-home.com/us or call 1-800-944-2904

© BSH Home Appliances Corporation. All rights reserved. Bosch is a registered trademark of Robert Bosch GmbH.