

PACKAGED TERMINAL AIR CONDITIONER (PTAC) AND HEAT PUMP

SPECIFICATIONS AND ACCESSORIES CATALOG

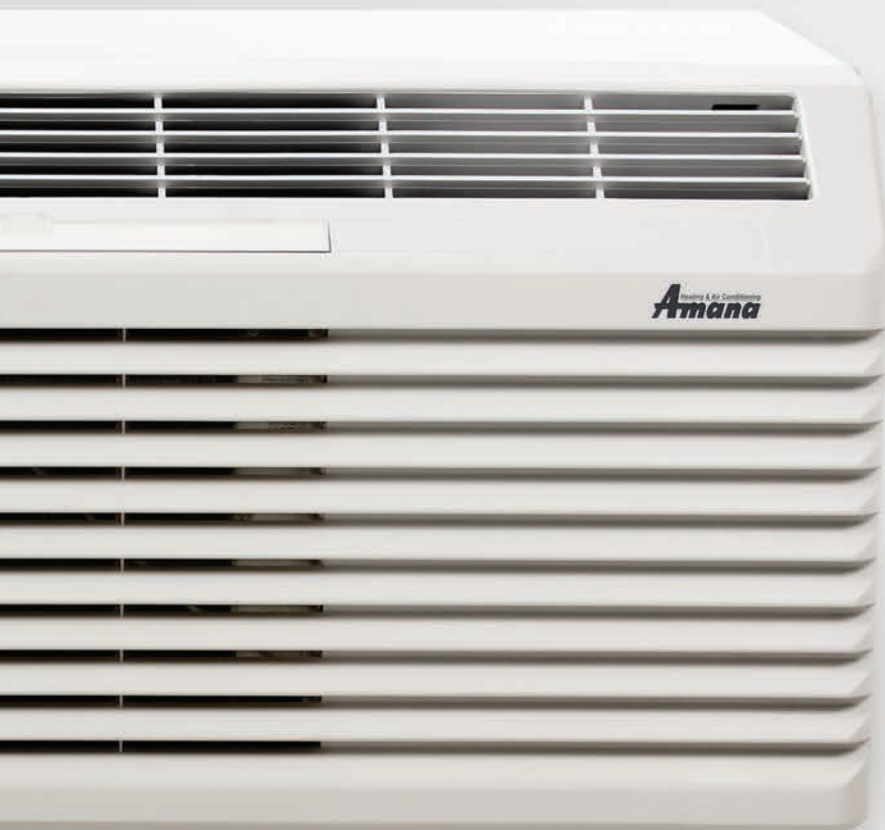

Our continuing commitment to quality products may mean a change in specifications without notice. **Amana**[®] is a registered trademark of Maytag Corporation or its related companies and is used under license. All rights reserved.

Copyright ©2023 Daikin Comfort Technologies Manufacturing, L.P.

PREMIUM
AMANA[®] BRAND
QUALITY

OUTSTANDING
PERFORMANCE AND
COMFORT

PREMIUM
ENERGY MANAGEMENT
SYSTEM



A COMBINATION OF ENERGY MANAGEMENT AND PTAC PERFORMANCE

AMANA® BRAND EDEN SOLUTIONS TIERS

IN-ROOM “SELF-INSTALLABLE” WIRELESS PERIPHERALS



The Eden™ Wireless Remote Thermostat can be mounted on the wall anywhere in the guest room. It is battery powered and capable of wireless communication with the PTAC to maintain room temperature. Best of all, there are no wires to run. The PTAC and thermostat connect at the press of a button and work in sync to display accurate temperature.



The Eden Occupancy Sensor and Door Switch Combo Device completes the in-room equipment. This infrared sensor can determine when the room is occupied. When empty, it signals the PTAC to adjust the temperature based on programmable setbacks to save energy.



The Eden Wireless Antenna installs inside the PTAC with a snap-in connector similar to a telephone jack. Installing the antenna allows the PTAC to communicate wirelessly with other devices in the room and the **Eden** network.

- Wireless installations since 2005: 60,000+ rooms
- Total wireless devices deployed to date: 425,000+

When combined with the self-installable wireless thermostat and occupancy sensor, the **Amana®** brand **Eden** PTAC with antenna gives the property owner complete control over the equipment settings and can reduce PTAC energy usage up to 35% or more.*

SITE-LEVEL CENTRAL WIRELESS CONTROLLER

- Site-wide PTAC configuration
- Site-wide PTAC diagnostics
- Front desk system interface
- Email reporting
- Internet accessible web user interface enterprise

*These savings represent estimated savings over time as compared to the same PTAC model without the **Eden** EMS installed; they were generated using general assumptions including energy loads, local weather averages and use of occupancy controls. Actual savings will vary according to use habits, room square footage and how the unit is installed and maintained.

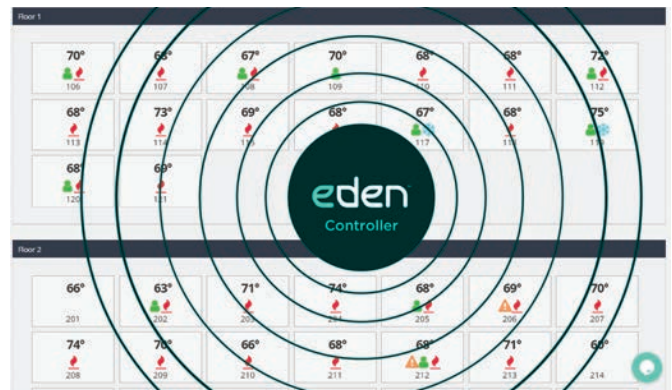



The **Amana** brand **Eden** control system brings together our best PTAC and our finest energy management software, which is now capable of integrating with optional property management and front desk management software. Reduce PTAC energy consumption up to 35% or more* with features such as the in-unit energy management system, programmable temperature setback and temperature limiting. The Maintenance Notification System adds value by helping head off potential PTAC service issues.

WEB-BASED MONITORING – AMANA BRAND EDEN CONTROLLER

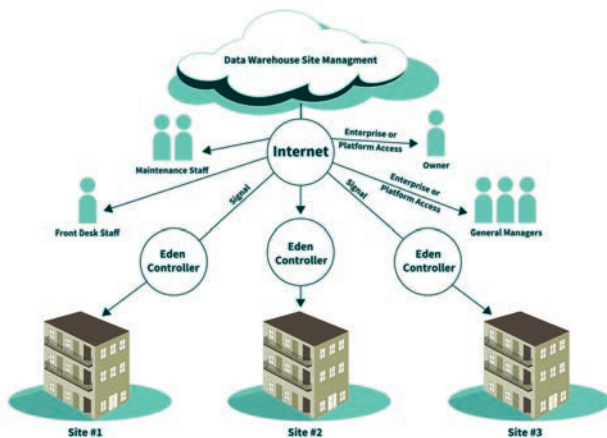

ENTERPRISE: MULTIPLE WIRELESS CONTROLLERS

Central monitoring and control of multiple properties

- Data warehousing
- Virtual metering
- Savings analysis
- Load shedding
- Email reporting

ALL PTACS IN A BUILDING CAN BE MANAGED THROUGH A SINGLE INTERFACE ON A PC

Features Include:

- Full unit details for every PTAC, visible from the front desk or home office
- Automatic emails for PTAC maintenance
- Ability to change all settings on the unit
- Enhanced diagnostics
- Monitors up to 250 PTACs wirelessly with one controller
- Expand the network with additional controllers
 - System verification
 - Email reporting
 - Global setbacks
 - Unit health
 - EMS configuration
 - Unit code alerts
 - Site statistics

Unrented Set-Points

By integrating with your property's Front Desk System, the PTACs will adjust to specific set-points when no longer identified as rented in the system.

Temperature Limiting

Each PTAC can be configured with a heating and cooling temperature set-point limit.

Setbacks

Once a room is declared unoccupied by the occupancy sensor, the PTAC progresses through three different temperature setbacks, configured as three degree and time pairs.

Example setback configuration:

1. 2°, 30 mins

Setback the temp 2 degrees after 30 minutes

2. 4°, 1 hr

Setback the temp 2 more degrees after 30 more minutes

3. 8°, 3 hrs

Setback the temp 4 more degrees after 2 more hours

*These savings represent estimated savings over time as compared to the same PTAC model without the **Eden** EMS installed; they were generated using general assumptions including energy loads, local weather averages and use of occupancy controls. Actual savings will vary according to use habits, room square footage and how the unit is installed and maintained.

STANDARD FEATURES

Energy Efficiencies: With EERs up to 14.0 and COPs up to 3.9, our unit's high efficiencies may qualify you for many of the rebates offered by electrical power companies.

Quiet Operation: Our PTAC has been redesigned to be the quietest PTAC we've ever built. The unit's state-of-the-art design and construction provide a quiet environment, allowing guests to enjoy peaceful, sleep-filled nights.

- Two fan motors (indoor/outdoor)
- Indoor tangential fan for quiet operation
- STC of 29

Integrated Bluetooth® Connectivity: Our **Amana** brand PTAC can now connect to our **Amana** brand mobile app, available in iOS and Google Play Store. This allows unmatched configuration flexibility, reduces unit setting and configuration time, as well as increased unit diagnostics and troubleshooting capability compared to previous generation **Amana** brand PTACs.

Integrated RF Communications: Each **Amana** brand PTAC has an integrated RF antenna to allow out-of-the-box connectivity to the **Eden** wireless thermostat (DS01G, sold separately) and **Eden** Concierge energy management system (separate fees apply). The **Amana** brand PTAC, when paired with the **Eden** Concierge energy management system, can reduce PTAC energy consumption by up to 35% or more.*

R32 Refrigerant: With a GWP (Global Warming Potential) of 677, California compliant R32 refrigerant is our choice for **Amana** brand PTACs. Available in every configuration of our PTAC, R32 refrigerant can provide up to 12% more efficiency than R410A refrigerant, lower lifetime emissions compared to R454B, and can use up to 40% less refrigerant charge than R410A.

Quiet White Room Front: Our newly redesigned Quiet White front cover provides a striking balance between attractive styling and practical design. This cover provides distinctive contours and a modern appearance to enhance the character of even the most luxurious room.

Assembled in the USA for Over 45 Years: Assembled at our plant in Waller, Texas, using Goodman resources including engineering, production and testing.

Five-Year Limited Warranty: Enjoy one of the most comprehensive warranties in the industry. First year includes parts and labor; second through fifth years includes parts and labor on certain sealed system components, on certain functional parts only. For complete warranty details, visit www.amana-ptac.com.

100% Run Tested: All units are 100% run tested at our plant in Waller, Texas, including leak checks during manufacturing and prior to shipment at the warehouse.

Filter Dryer for Sealed System Refrigerant: Standard in all units to protect the compressor and lengthen the life of the unit by removing moisture and preventing acid formation.

Front Desk Control: Each unit comes equipped with the **Eden** control and energy management software. Using the **Eden** software and the PTAC's integrated RF antenna, all units can be wirelessly connected to a central hub for enhanced energy savings and diagnostics. **Amana** brand PTACs also have a low-voltage interface capability with a field-supplied front desk ON/OFF switch. (See page 2)

The Bluetooth® word mark and logos are registered trademarks owned by Bluetooth SIG, Inc., and any use of such marks are under license.

*These savings represent estimated savings over time as compared to the same PTAC model without the **Eden** EMS installed; they were generated using general assumptions including energy loads, local weather averages and use of occupancy controls. Actual savings will vary according to use habits, room square footage and how the unit is installed and maintained.

Easy Pull-Out Filters: Our filters are washable and easy to maintain.

7⁵/₈" Unit Front Depth: Enhance valuable room space with our slim unit front, which has a sleek 7⁵/₈" depth, one of the shallowest silhouettes in the industry today. The front can be secured to the chassis with a hidden screw in order to inhibit guest tampering.

Condensate Dispersion System: Our condensate dispersion system removes condensate from the indoor cooling operation by throwing water directly onto the outdoor coil for rapid evaporation and increased cooling efficiencies. The slinger ring on the enhanced fan draws water up and into the fan blades. This water is then atomized and evaporated into the atmosphere through the condenser. Increased surface area from the coil allows more water to be evaporated on the sides of the coils and helps to minimize condensate run-off.

Room Freeze Protection: When the unit senses temperatures of 40°F or below, the unit activates the fan motor and either the electric resistance heater or the hydronic heater.

Zero Floor Clearance: The unit can be installed flush to a finished floor, if desired (please note that some accessories do not have zero clearance).

30-Second Fan-Off Delay: The fan continues to run 30 seconds after the compressor has stopped in either cooling or heat pump mode, and after electric heat has been turned off. This improves efficiency by dispersing the conditioned air on the coils into the room.

Compressor Lock-In: This feature helps prolong the life of the compressor by preventing short-cycling. When the compressor is switched from OFF to ON because room temperature has risen or fallen below the specified limit, it will remain on for at least 4 minutes. If the temperature set-point is changed during this 4 minutes, the lock-in feature is overridden.

Automatic Emergency Heat: No more "my unit is not heating" complaints during the middle of the night. Heat pump units will automatically switch over to electric resistance heat if the heat pump compressor system fails or if the heating load is greater than the unit capacity.

Constant Fan Mode: Take advantage of continuous fan operation. Each unit can be configured with our **Amana** brand mobile app or paired with a supporting thermostat to provide constant fan operation.

Hidden Ventilation Control: The ventilation control lever is hidden from the occupant's view to allow you to manage ventilation requirements.

High-Pressure Switch: Protects the unit from high pressure and damage to the unit, helping to ensure long unit life.

Smart Vent and Economizer: Available on **Amana** brand PTACs with the power vent fan and power vent door options (feature code "V" and "D"). Choose how to bring in up to 95 CFM (Power Vent Fan) of outside air into your guest room. Ability to control operation based on heat limits, cold limits, and humidity limits. With the economizer function, you can bring in outdoor air to cool your room when outdoor temperatures are right. Features configurable temperature delta for activation between guest room and outdoor makeup air with an optional compressor assist option.

NOMENCLATURE -

		PTC	07	3	J	35	AXXX	AA				
		1,2,3	4,5	6	7	8,9	10,11,12,13	14,15				
Basic Model Type								Engineering				
PTC	Standard Cooler PTAC							Major & Minor Revisions				
PTH	Standard Heat Pump PTHP											
HEC	High-Efficiency Cooler PTAC							Features Code *				
HEH	High-Efficiency Heat Pump							A	Standard Model			
DRY	Dehumid Cooler PTAC							C	Corrosion Protection (Seacoast)			
PMC	DigiAIR Cooler PTAC							D	Power Door (not for DigiAir models)			
PMH	DigiAIR Heat Pump PTAC							E	DigiAir Supplemental Heater			
								L	Lighting Control			
								H	Hydronic-Heat Capable			
								V	Power Vent (not for DigiAir models)			
								X	Placeholder			
Nominal Cooling Capacity*								Heater Size				
07	7,000 BTU/h	60 Hz							00	No Electric Heat	35	3.5 kW (230/208V)
09	9,000 BTU/h	60 Hz							15	1.5 kW		3.7 kW (265V)
12	12,000 BTU/h	60 Hz							25	2.5 kW	50	5.0 kW
15	15,000 BTU/h	60 Hz										
17	17,000 BTU/h	60 Hz										
* Not all cooling capacities are available for each model type shown above. See actual data on the following pages for available combinations.												
Rated Voltage**												
3	230/208V, 60 Hz, 1 Phase											
4	265V, 60 Hz, 1 Phase											
** Not all rated voltages are available for each model type and cooling capacity shown above. See actual data on following pages for available combinations.												
Design Series												
J	2023 R32 Refrigerant											
K	2023 R410A Refrigerant											
								* Use up to 4 as needed in alphabetical order. Examples:				
								PTC123*50AXXX		PTC073*35CLXX		
								PTC123*50CXXX		PTC073*25CLVW		

POWER CORD CONFIGURATION

Power Cord Plugs		Power Receptacle Configuration	
<p>250V Rating Power Cord Plugs with LCDI Device NEMA 6 Configuration</p> <p>15 amp 20 amp 30 amp</p>		<p>NEMA6-15R; 250V receptacle used on 230/208V units NEMA6-20R; 250V receptacle used on 230/208V units NEMA6-30R; 250V receptacle used on 230/208V units</p>	
<p>277V Rating Power Cord Plugs NEMA 7 Configuration</p> <p>20 amp 30 amp</p>		<p>NEMA7-20R; 277V receptacle used on 265V units NEMA7-30R; 277V receptacle used on 265V units</p>	
<p>All units come with factory-installed power cords. All units less than 250 volts come with LCDI device.</p>			

PRODUCT SPECIFICATIONS: PTC MODELS—COOLING/ELECTRIC HEAT

PTC R32 J Models										
Model ^{1,5,6,8,9}	PTC073J **AXXX	PTC093J **AXXX	PTC123J **AXXX	PTC153J **AXXX	PTC173J **AXXX	PTC074J **AXXX	PTC094J **AXXX	PTC124J **AXXX	PTC154J **AXXX	
Voltage ^{1,3}	230/208	230/208	230/208	230/208	230/208	265	265	265	265	
Capacity (BTU/h)	7,000/7,000	9,200/ 9,000	11,900/ 11,700	14,800/ 14,900	16,400/ 16,700	7,000	9,200	11,800	14,800	
Amps ¹⁰	3.2/3.2	4.1/4.1	5.6/5.6	7.1/7.1	7.8	2.7	3.6	4.9	6.3	
Watts ¹⁰	545/545	760/750	1,040/1,015	1,435/1,430	1,575/1,575	535	770	1,050	1,380	
EER	12.8/12.8	12.1/12.2	11.4/11.5	10.3/10.4	10.4/10.6	13	11.9	11.2	10.7	
Unit without electric heater										
Min. circuit amps ^{2,4,10}	3.7	4.9	7.4	8.5	9.4	3.2	4.4	5.8	7.4	
CFM (cool/ wet coil)	high	330	290	330	400	400	330	290	330	400
	low	245	264	245	314	314	245	264	245	314
CFM (dry coil)	high	343	321	313	412	412	339	343	335	414
	low	309	295	285	390	390	339	343	335	414
Ventilated air, CFM (fan only)*	65**	65**	65**	65**	65**	65*	65**	65**	65**	
Dehumidification (pints/hr.)	1.7	2	1.7	4.4	4.4	1.7	2	1.7	4.4	
Net weight (lbs.)	106	102	108	113	113	103	102	108	113	
Ship weight (lbs.)	115	117	125	130	130	115	117	125	130	

PTC R410A K Models										
Model ^{1,5,6,8,9}	PTC073K **AXXX	PTC093K **AXXX	PTC123K **AXXX	PTC153K **AXXX	PTC173K **AXXX	PTC074K **AXXX	PTC094K **AXXX	PTC124K **AXXX	PTC154K **AXXX	
Voltage ^{1,3}	230/208	230/208	230/208	230/208	230/208	265	265	265	265	
Capacity (BTU/h)	7,000/ 7,000	9,200/ 9,000	11,900/ 11,600	14,800/ 14,500	16,700/ 16,400	7,000	9,200	11,800	14,800	
Amps ¹⁰	3.1/3.1	4.2/4.2	6.1/6.1	7.1/7.1	9.5	2.7	3.6	5.4	6.8	
Watts ¹⁰	580/560	790/765	1,080/1,050	1,480/1,450	1,720/1,690	585	810	1,100	1,480	
EER	12.0/12.4	11.6/11.7	11.0/11.0	10.0/10.0	9.7/9.7	11.9	11.3	10.7	10	
Unit without electric heater										
Min. circuit amps ^{2,4,10}	3.7	4.9	7.4	8.5	11.4	3.2	4.4	5.8	7.4	
CFM (cool/ wet coil)	high	330	330	330	400	400	340	330	330	400
	low	245	264	245	314	314	245	264	245	314
CFM (dry coil)	high	336	325	334	408	412	328	345	343	420
	low	309	301	310	384	390	328	345	343	420
Ventilated air, CFM (fan only)*	65**	65**	65**	65**	65**	65*	65**	40**	65**	
Dehumidification (pints/hr.)	1.7	2	1.7	4.4	4.4	1.7	2	1.7	4.4	
Net weight (lbs.)	106	102	108	113	113	103	102	108	113	
Ship weight (lbs.)	115	117	125	130	130	115	117	125	130	

*Actual vent CFM performance will vary due to application and installation conditions. 95 CFM with Power Vent Fan option (Feature Code "v")

Notes

- All 265-volt models must use an Amana® brand sub-base (PTSB4**E) or an Amana® brand hard-wire kit PTPWHWK4 and disconnect switch PSHW04A.
- Minimum Circuit Ampacity (MCA) ratings conform to the National Electric Code; however, local codes should apply.
- Minimum voltage on 230/208-volt models is 197 volts; maximum is 253 volts. Minimum voltage on 265-volt models is 239 volts; maximum is 292 volts.
- Overcurrent protection for all units without electric heaters is 15 amps. Overcurrent protection on 265-volt models must be cartridge-style time-delay fuses (included and factory-installed on all Amana® brand 265-volt chassis). See heater performance.

- Heating capacity and efficiency based on unit operation without condensate pump.
- Specify two-digit heater kW size to complete model number.
- R32 or R410A refrigerant used in all systems.
- All units meet or exceed ASHRAE 90.1 standards.
- All units less than 250 volts have a Leak Current Detector Interrupter (LCDI) powercord and meet UL 484 standards.
- Refer to electric heat performance data for total MCA and recommended overcurrent protection. Amps and watts notation refers to compressor only.

PRODUCT SPECIFICATIONS: PTH R32 J MODELS— COOLING/HEAT PUMP/AUXILIARY ELECTRIC HEAT

PTH R32 J Models									
Model ^{1,5,6,8,9}	PTH073J **AXXX	PTH093J **AXXX	PTH123J **AXXX	PTH153J **AXXX	PTH074J **AXXX	PTH094J **AXXX	PTH124J **AXXX	PTH154J **AXXX	
Cooling									
Voltage ^{1,3}	230/208	230/208	230/208	230/208	265	265	265	265	
Capacity (BTU/h)	7,100/7,000	9,000/9,000	12,000/11,600	14,600/14,400	7,300	9,000	12,000	14,600	
Amps ¹⁰	3.2	4.0	5.6	7.1	2.8	3.5	4.9	6.6	
Watts ¹⁰	570/545	725/720	1,040/1,005	1,400/1,355	585	725	1,060	1,405	
EER	12.4/12.8	12.4/12.5	11.5/11.5	10.4/10.6	12.5	12.4	11.3	10.4	
Heating									
Capacity (BTU/h)	6,300/6,100	8,200/8,000	11,000/10,800	14,300/14,000	6,500	8,200	11,500	14,100	
Amps ¹⁰	3.2	4.0	5.6	7.1	2.8	3.5	4.9	6.6	
Watts ¹⁰	510/480	665/650	980/955	1,350/1,320	545	685	1,020	1,375	
COP	3.6/3.7	3.6/3.6	3.3/3.3	3.1/3.1	3.5	3.5	3.3	3.0	
Unit without Electric Heater									
Min. circuit amps ^{2,4,10}	3.7	4.9	7.4	8.5	3.2	4.4	5.8	7.4	
CFM (cool/ wet coil)	high	330	290	330	400	330	290	330	400
	low	245	264	245	314	245	264	245	314
CFM (dry coil)	high	335	321	315	362	344	320	324	381
	low	307	292	293	348	344	320	324	381
Ventilated air, CFM (fan only)*	65 - 95	65 - 95	65 - 95	65 - 95	65 - 95	65 - 95	65 - 95	65 - 95	
Dehumidification (pints/hour)	1.7	2	1.7	4.4	1.7	2	1.7	4.4	
Net weight (lbs.)	106	102	108	113	103	102	108	113	
Ship weight (lbs.)	115	117	125	130	115	117	125	130	

*Actual vent CFM performance will vary due to application and installation conditions. 95 CFM with Power Vent Fan option (Feature Code "V")

Notes

- All 265-volt models must use an **Amana** brand sub-base (PTSB4**E) or an **Amana** brand hard-wire kit PTPWHWK4 and disconnect switch PSHW04A.
- Minimum Circuit Ampacity (MCA) ratings conform to the National Electric Code; however, local codes should apply.
- Minimum voltage on 230/208-volt models is 197 volts; maximum is 253 volts. Minimum voltage on 265-volt models is 239 volts; maximum is 292 volts.
- Overcurrent protection for all units without electric heaters is 15 amps. Overcurrent protection on 265-volt models must be cartridge-style time-delay fuses (included and factory-installed on all **Amana** brand 265-volt chassis). See heater performance.
- Heating capacity and efficiency based on unit operation without condensate pump.
- Specify two-digit heater kW size to complete model number.
- R32 refrigerant used in all systems.
- All units meet or exceed ASHRAE 90.1 standards.
- All units less than 250 volts have a Leak Current Detector Interrupter (LCDI) power cord and meet UL 484 standards.
- Refer to electric heat performance data for total MCA and recommended overcurrent protection. Amps and watts notation refers to compressor only.

PRODUCT SPECIFICATIONS: HEC (HIGH EFFICIENCY) R32 J MODELS— COOLING/ELECTRIC HEAT

HEC R32 J Models									
Model ^{1,5,6,8,9}	HEC073J **AXXX	HEC093J **AXXX	HEC123J **AXXX	HEC153J **AXXX	HEC074J **AXXX	HEC094J **AXXX	HEC124J **AXXX	HEC154J **AXXX	
Voltage ^{1,3}	230/208	230/208	230 / 208	230/208	265	265	265	265	
Capacity (BTU/h)	7,000/ 7,000	9,200/ 9,000	11,700/ 11,400	14,800/ 14,500	7,000	9,200	11,800	14,800	
Amps ¹⁰	3.1/3.1	4.1/4.1	6.1/6.1	7.0/7.0	2.7	3.6	4.8	6.1	
Watts ¹⁰	530/515	690/680	1,015/965	1,355/1,305	550	700	1,045	1,375	
EER	13.8/13.6	12.8/12.8	11.9/11.9	10.7/10.8	14	12.7	11.6	11.2	
Unit without Electric Heater									
Min. circuit amps ^{2,4,10}	3.7	4.9	7.4	8.5	3.2	4.4	5.8	7.4	
CFM (cool/ wet coil)	high	330	290	330	400	330	290	330	400
	low	245	264	245	314	245	264	245	314
CFM (dry coil)	high	342	318	316	412	342	318	316	412
	low	342	318	316	412	342	318	316	412
Ventilated air, CFM (fan only)*	65 - 95	65 - 95	65 - 95	65 - 95	65 - 95	65 - 95	65 - 95	65 - 95	
Dehumidification (pints/hour)	1.7	2	1.7	4.4	1.7	2	1.7	4.4	
Net weight (lbs.)	106	102	108	113	103	102	108	113	
Ship weight (lbs.)	115	117	125	130	115	117	125	130	

*Actual vent CFM performance will vary due to application and installation conditions. 95 CFM with Power Vent Fan option (Feature Code "v")

Notes

- All 265-volt models must use an **Amana** brand sub-base (PTSB4**E) or an **Amana** brand hard-wire kit PTPWHWK4 and disconnect switch PSHW04A.
- Minimum Circuit Ampacity (MCA) ratings conform to the National Electric Code; however, local codes should apply.
- Minimum voltage on 230/208-volt models is 197 volts; maximum is 253 volts. Minimum voltage on 265-volt models is 239 volts; maximum is 292 volts.
- Overcurrent protection for all units without electric heaters is 15 amps. Overcurrent protection on 265-volt models must be cartridge-style time-delay fuses (included and factory-installed on all **Amana** brand 265-volt chassis). See heater performance.
- Heating capacity and efficiency based on unit operation without condensate pump.
- Specify two-digit heater kW size to complete model number.
- R32 refrigerant used in all systems.
- All units meet or exceed ASHRAE 90.1 standards.
- All units less than 250 volts have a Leak Current Detector Interrupter (LCDI) power cord and meet UL 484 standards.
- Refer to electric heat performance data for total MCA and recommended overcurrent protection. Amps and watts notation refers to compressor only.

PRODUCT SPECIFICATIONS: HEH (HIGH EFFICIENCY) R32 J MODELS COOLING/HEAT PUMP/AUXILIARY ELECTRIC HEAT

HEH R32 J Models								
Model ^{1,5,6,8,9}	HEH073J **AXXX	HEH093J **AXXX	HEH123J **AXXX	HEH153J **AXXX	HEH074J **AXXX	HEH094J **AXXX	HEH124J **AXXX	
Cooling								
Voltage ^{1,3}	230/208	230/208	230/208	230/208	265	265	265	
Capacity (BTU/h)	7,100/7,100	9,000/9,000	12,000/11,600	14,500/14,400	7,300	9,100	12,100	
Amps ¹⁰	3.0	3.9	5.4	6.7	2.7	3.4	4.7	
Watts ¹⁰	530/515	690/680	1,015/965	1,355/1,305	550	700	1,045	
EER	13.3/13.7	13.0/13.2	11.8/12.0	10.7/11.0	13.3	13	11.6	
Heating								
Capacity (BTU/h)	6,300/6,100	8,200/8,000	11,100/10,900	14,400/14,200	6,600	8,300	11,600	
Amps ¹⁰	3.0	3.9	5.4	6.7	2.7	3.4	4.7	
Watts ¹⁰	470/455	615/600	955/935	1,315/1,300	495	640	1,000	
COP	3.9/3.9	3.9/3.9	3.4/3.4	3.2/3.2	3.9	3.8	3.4	
Unit without Electric Heater								
Min. circuit amps ^{2,4,10}	3.7	4.9	7.4	8.5	3.2	4.4	5.8	
CFM (cool/ wet coil)	high	330	290	330	400	330	290	330
	low	245	264	245	314	245	264	245
CFM (dry coil)	high	339	312	293	354	339	312	311
	low	339	312	291	354	339	312	311
Ventilated air, CFM (fan only)*	65 - 95	65 - 95	65 - 95	65 - 95	65 - 95	65 - 95	65 - 95	
Dehumidification (pints/hour)	1.7	2	1.7	4.4	1.7	2	1.7	
Net weight (lbs.)	106	102	108	113	103	102	108	
Ship weight (lbs.)	115	117	125	130	115	117	125	

*Actual vent CFM performance will vary due to application and installation conditions. 95 CFM with Power Vent Fan option (Feature Code "v")

Notes

- All 265-volt models must use an **Amana** brand sub-base (PTSB4**E) or an **Amana** brand hard-wire kit PTPWHWK4 and disconnect switch PSHW04A.
- Minimum Circuit Ampacity (MCA) ratings conform to the National Electric Code; however, local codes should apply.
- Minimum voltage on 230/208-volt models is 197 volts; maximum is 253 volts. Minimum voltage on 265-volt models is 239 volts; maximum is 292 volts.
- Overcurrent protection for all units without electric heaters is 15 amps. Overcurrent protection on 265-volt models must be cartridge-style time-delay fuses (included and factory-installed on all **Amana** brand 265-volt chassis). See heater performance.
- Heating capacity and efficiency based on unit operation without condensate pump.
- Specify two-digit heater kW size to complete model number.
- R32 refrigerant used in all systems.
- All units meet or exceed ASHRAE 90.1 standards.
- All units less than 250 volts have a Leak Current Detector Interrupter (LCDI) power cord and meet UL 484 standards.
- Refer to electric heat performance data for total MCA and recommended overcurrent protection. Amps and watts notation refers to compressor only.

PRODUCT SPECIFICATIONS: PMH R32 J MODELS— COOLING/HEAT PUMP/AUXILIARY ELECTRIC HEAT

PMH R32 J Models							
Model ^{1,5,6,8,9}	PMH073J **AXXX	PMH093J **AXXX	PMH123J **AXXX	PMH153J **AXXX	PMH074J **AXXX	PMH094J **AXXX	PMH124J **AXXX
Cooling							
Voltage ^{1,3}	230/208	230/208	230/208	230/208	265	265	265
Capacity (BTU/h)	6,900/6,700	8,700/8,700	11,400/11,200	14,400/14,200	7,300	9,000	12,000
Amps ¹⁰	4.4/4.4	5.2/5.2	6.7/6.7	8.1/8.1	3.8	4.5	5.8
Watts ¹⁰	545/525	700/695	1,005/970	1,410/1,350	585	730	1,090
EER	12.6/12.7	12.4/12.5	11.3/11.5	10.2/10.5	12.4	12.3	11.0
Heating							
Capacity (BTU/h)	6,200/6,100	7,800/7,600	10,600/10,400	13,900/13,700	6,500	8,000	11,300
Amps ¹⁰	4.4	5.2	6.7	8.1/8.1	3.8	4.5	6.7
Watts ¹⁰	505/495	635/615	940/920	1,355/1,295	540	670	1035
COP	3.6/3.6	3.6/3.6	3.3/3.3	3.0/3.1	3.5	3.5	3.2
CFM (cooling)	339/339	312/312	291/293	354/354	339	312	311
CFM (heating)	378/378	345/345	320/323	370/370	378	345	327
Kit fresh air, CFM*	25 - 35	25 - 35	25 - 35	25 - 35	25 - 35	25 - 35	25 - 35

*Actual vent CFM performance will vary due to application and installation conditions. 95 CFM with Power Vent Fan option (Feature Code "v"). Actual CFM will be conditional on building pressure

Notes

- All 265-volt models must use an **Amana** brand sub-base (PTSB4**E) or an **Amana** brand hard-wire kit PTPWHWK4 and disconnect switch PSHW04A.
- Minimum Circuit Ampacity (MCA) ratings conform to the National Electric Code; however, local codes should apply.
- Minimum voltage on 230/208-volt models is 197 volts; maximum is 253 volts. Minimum voltage on 265-volt models is 239 volts; maximum is 292 volts.
- Overcurrent protection for all units without electric heaters is 15 amps. Overcurrent protection on 265-volt models must be cartridge-style time-delay fuses (included and factory-installed on all **Amana** brand 265-volt chassis). See heater performance.
- Heating capacity and efficiency based on unit operation without condensate pump.
- Specify two-digit heater kW size to complete model number.
- R32 refrigerant used in all systems.
- All units meet or exceed ASHRAE 90.1 standards.
- All units less than 250 volts have a Leak Current Detector Interrupter (LCDI) power cord and meet UL 484 standards.
- Refer to electric heat performance data for total MCA and recommended overcurrent protection. Amps and watts notation refers to compressor only.

PRODUCT SPECIFICATIONS: DRY (ENHANCED DEHUMIDIFICATION) R32 J MODELS - COOLING/ELECTRIC HEAT

PTC R32 J Models		
Model ^{1,5,6,8,9}	DRY093J **AXXX	DRY094J **AXXX
Voltage ^{1,3}	230/208	265
Capacity (BTU/h)	9,000/9,000	8,800
Amps ¹⁰	4.3	3.8
Watts ¹⁰	760/760	750
EER	11.8/11.8	11.7
Unit without Electric Heater		
Min. circuit amps ^{2,4,10}	4.9	4.4
CFM (cool/ wet coil)	high	290
	low	264
CFM (dry coil)	high	321
	low	295
Ventilated air, CFM (fan only)*	65**	65**
Dehumidification (pints/hr.)	2.6	2.6
Net weight (lbs.)	105	105
Ship weight (lbs.)	120	120

*Actual vent CFM performance will vary due to application and installation conditions. 95 CFM with Power Vent Fan option (Feature Code "v")

PRODUCT SPECIFICATIONS: PMC R32 MODELS—COOLING/ELECTRIC HEAT

PMC R32 J Models								
Model ^{1,5,6,8,9}	PMC073J **AXXX	PMC093J **AXXX	PMC123J **AXXX	PMC153J **AXXX	PMC074J **AXXX	PMC094J **AXXX	PMC124J **AXXX	PMC154J **AXXX
Voltage ^{1,3}	230/208	230/208	230/208	230/208	265	265	265	265
Capacity (BTU/h)	6,800/ 6,700	9,000/ 8,700	11,800/ 11,700	14,500/ 14,400	6,800	9,000	11,800	14,500
Amps ¹⁰	4.4/4.4	5.2/5.2	6.7/6.7	8.1/8.1	3.8	4.5	5.8	7.2
Watts ¹⁰	535/520	730/715	1,025/1,015	1,390/1,370	535	750	1,070	1,380
EER	12.7/12.8	12.3/12.1	11.5/11.5	10.4/10.5	12.7	12	11	10.5
CFM	342/342	318/318	316/316	412/412	342	318	316	412
Kit fresh air, CFM*	25 - 35	25 - 35	25 - 35	25 - 35	25 - 35	25 - 35	25 - 35	25 - 35

*Actual vent CFM performance will vary due to application and installation conditions. 95 CFM with Power Vent Fan option (Feature Code "v"). Actual CFM will be conditional on building pressure

PRODUCT SPECIFICATIONS: ALL MODELS—ELECTRIC HEAT PERFORMANCE

(Primary heating for PTC, HEC, PMC models; auxiliary heating for PTH, HEH, PMH models; see below for power cord configuration)

Voltage	Electric Heater Size (kW)	No. of Stages	Nominal Heating (BTU/h)			Total Watts ⁶	Total Amps	Min. Circuit Ampacity ²	MOP ⁴ (Amps)	Power Cord
			@230V	@208V	@265V					
230/208	1.5/1.3	1	5,100	4,200	-	1,570/1,295	6.8/6.2	8.5	15	6 - 15 P
230/208	2.5/2.1	1	8,500	6,800	-	2,570/2,115	11.2/10.1	14.1	15	6 - 15 P
230/208	3.5/3.0	1	12,000	9,900	-	3,570/2,935	15.5/14.1	19.5	20	6 - 20 P
230/208	5.0/4.1	1	17,100	14,000	-	5,070/4,160	22.1/20.0	27.6	30	6 - 30 P
265	1.5	1	-	-	5,100	1,570	5.9	7.4	15	7 - 20 P
265	2.5	1	-	-	8,500	2,570	9.7	12.2	15	7 - 20 P
265	3.7	1	-	-	12,600	3,770	14.2	17.9	20	7 - 20 P
265	5.0	1	-	-	17,100	5,070	19.2	23.9	25	7 - 30 P

Notes

- All 265-volt models must use an **Amana** brand sub-base (PTSB4**E) or an **Amana** brand hard-wire kit PTPWHWK4 and disconnect switch PSHWO4A.
- Minimum Circuit Ampacity (MCA) ratings conform to the National Electric Code; however, local codes should apply.
- Minimum voltage on 230/208-volt models is 197 volts; maximum is 253 volts. Minimum voltage on 265-volt models is 239 volts; maximum is 292 volts.
- Overcurrent protection for all units without electric heaters is 15 amps. Overcurrent protection on 265-volt models must be cartridge-style time-delay fuses (included and factory-installed on all **Amana** brand 265-volt chassis). See heater performance.
- Heating capacity and efficiency based on unit operation without condensate pump.
- Specify two-digit heater kW size to complete model number.
- R32 or R410A refrigerant used in all systems.
- All units meet or exceed ASHRAE 90.1 standards.
- All units less than 250 volts have a Leak Current Detector Interrupter (LCDI) power cord and meet UL 484 standards.
- Refer to electric heat performance data for total MCA and recommended overcurrent protection. Amps and watts notation refers to compressor only.

ACCESSORIES

Wall Sleeves

All our wall sleeves have industry standard dimensions of 42" wide x 16 $\frac{1}{8}$ " high. The WS900QW, SC and internal 14 $\frac{1}{8}$ " depth is the industry-standard. Sleeves may be shipped separately to allow for installation during construction.

Standard-Depth Sleeves

WS900QW	Standard PTAC sleeve
WS900QW-SC	Seacoast triple protected
WS900QW-GS	Heavy sound isolation insulation sleeve
WS900QW-INTERNAL	Internal drain only for window-wall installations (DK900QW sold separately)

Wall Sleeves: Available in several depths for thicker wall installations or special room configurations.

WS9xxQW-C	Collapsible and disassembled for efficient shipping. 16" to 24" in 1" increments. Also available in 28", 30", 32", 36" and 40".
WS9xxQW-CFA	Collapsible and fully assembled. 16" to 24" in 1" increments. Also available in 28", 30", 32", 36", and 40".

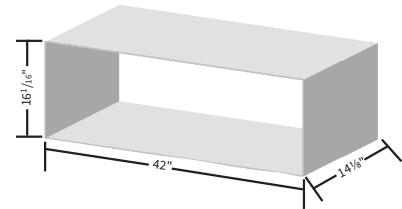

Outdoor Grilles

Available in stamped aluminum or architecturally louvered for application with an **Amana** brand WS900QW wall sleeve.

AGK: Extruded aluminum architectural grille available with an anodized aluminum finish or a baked-on paint finish for durability. Choose from 5 stock colors or a custom color to blend with your building's exterior color scheme. **Colors include:**
CB (clear anodized), DB (dark brown/bronze), TB (stonewood beige), WB (white), QW (quiet white), SB (special/custom colors)

PGK: One-piece injection-molded grille made using a polymer blend of engineered thermoplastic high-impact strength material with chemical resistance and an exterior UV protective coating. **Choose from 4 stock colors:**
DB (dark brown/bronze), TB (stonewood beige), WB (white), QW (quiet white)

Standard Outdoor Grille

SGK01B	Single pack
SGK01QW	Quiet white

Architectural Outdoor Grille

AGK01CB	Anodized aluminum
AGK01DB	Dark bronze/brown
AGK01TB	Stonewood beige
AGK01WB	Amana white
AGK01QW	Quiet white
AGK01SB	Custom colors
PGK01DB	Dark bronze/brown
PGK01TB	Stonewood beige
PGK01WB	Amana white
PGK01QW	Quiet white

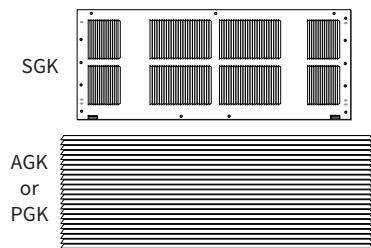

Condensate Drain Kit

Attaches to the wall sleeve base pan for controlled internal or external disposal of condensate.

DK900D	Condensate drain kit (use with WS900E)
DK900QW	Condensate drain kit (use with WS900QW)

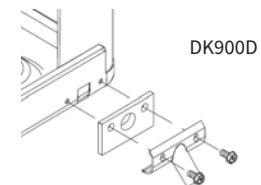

Low-Voltage Wire Harness Kit (not shown)

For quick connections of remote or wired thermostats, wired EMS or front desk with jumpers and connectors.

PWHK01G90	Wire harness kit
------------------	------------------

ACCESSORIES (CONT.)

<p>Sub-Base Kit The fully skirted sub-base conceals wiring while providing strong support, if needed. Plug-in receptacle and field-wiring access speeds installation. Electrical accessories such as fuse holders, circuit breakers and disconnect switches meet N.E.C. requirements.</p>	<table border="1"> <tbody> <tr> <td>PTSB320QW</td> <td>230/208V 15/20A</td> </tr> <tr> <td>PTSB330QW</td> <td>230/208V 30A</td> </tr> <tr> <td>PTSB420QW</td> <td>265V 15/20A</td> </tr> <tr> <td>PTSB430QW</td> <td>265V 25A</td> </tr> <tr> <td>PTSB000QW</td> <td>Non-electrical</td> </tr> </tbody> </table>	PTSB320QW	230/208V 15/20A	PTSB330QW	230/208V 30A	PTSB420QW	265V 15/20A	PTSB430QW	265V 25A	PTSB000QW	Non-electrical			
PTSB320QW	230/208V 15/20A													
PTSB330QW	230/208V 30A													
PTSB420QW	265V 15/20A													
PTSB430QW	265V 25A													
PTSB000QW	Non-electrical													
<p>Leveling Legs Gives wall sleeve front support and helps to level the unit for installation.</p>	<table border="1"> <tbody> <tr> <td>LL2QW</td> <td>Leveling legs for WS9**QW sleeves</td> </tr> </tbody> </table>	LL2QW	Leveling legs for WS9**QW sleeves											
LL2QW	Leveling legs for WS9**QW sleeves													
<p>Hard-Wire Kits Used to permanently wire to the chassis when a standard sub-base and power cord are not utilized. Factory Installed Feature Code - W</p>	<table border="1"> <tbody> <tr> <td>PTPWHWK4</td> <td>Armored cable - all voltages</td> </tr> <tr> <td>PTQC3A</td> <td>Quick connect - 230/208V</td> </tr> <tr> <td>PTQC4A</td> <td>Quick connect - 265/115V</td> </tr> </tbody> </table>	PTPWHWK4	Armored cable - all voltages	PTQC3A	Quick connect - 230/208V	PTQC4A	Quick connect - 265/115V							
PTPWHWK4	Armored cable - all voltages													
PTQC3A	Quick connect - 230/208V													
PTQC4A	Quick connect - 265/115V													
<p>Power Disconnect Switch The PSHW**A power disconnect switch can be used for 265-volt or 230/208-volt physical disconnect, where required by local codes. The switch is rated at 30-amp capacity. The switch is for use with Amana brand standard sub-bases or PTPWHWK4 hard wire kit.</p>	<table border="1"> <tbody> <tr> <td>PSHW03A</td> <td>230/208V</td> </tr> <tr> <td>PSHW04A</td> <td>265V</td> </tr> </tbody> </table>	PSHW03A	230/208V	PSHW04A	265V									
PSHW03A	230/208V													
PSHW04A	265V													
<p>Fuse Holder Kit Cartridge-style fuses can be installed in the fuse holder for use in the sub-base or chassis. Available in 15, 20 and 30 amp (included on 265-volt unit).</p>	<table border="1"> <tbody> <tr> <td>FHK315K</td> <td>230/208V 15A - J & K series</td> </tr> <tr> <td>FHK315E</td> <td>230/208V 15A - R-410A</td> </tr> <tr> <td>FHK320K</td> <td>230/208V 20A - J & K series</td> </tr> <tr> <td>FHK320E</td> <td>230/208V 20A - R-410A</td> </tr> <tr> <td>FHK330C</td> <td>230/208V 30A - J & K series</td> </tr> <tr> <td>FHK330K</td> <td>230/208V 30A - R-410A</td> </tr> </tbody> </table>	FHK315K	230/208V 15A - J & K series	FHK315E	230/208V 15A - R-410A	FHK320K	230/208V 20A - J & K series	FHK320E	230/208V 20A - R-410A	FHK330C	230/208V 30A - J & K series	FHK330K	230/208V 30A - R-410A	
FHK315K	230/208V 15A - J & K series													
FHK315E	230/208V 15A - R-410A													
FHK320K	230/208V 20A - J & K series													
FHK320E	230/208V 20A - R-410A													
FHK330C	230/208V 30A - J & K series													
FHK330K	230/208V 30A - R-410A													

ACCESSORIES (CONT.)

Duct Extension Kit

Extends air distribution to an adjoining room. Consists of a main duct for the room of origin and an extension duct to reach the adjoining room and terminal duct. PTDK01A allows for the "B" series unit to work with the "A" series duct kits.

MDK01QW	Main duct kit - J & K series
EDK02QW	42" extension duct - J & K series

Main Duct Kit

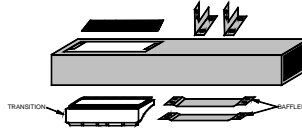

Extension Duct Kit



TDK02QW	Terminal duct - J & K series
PTDK01QW	Transition duct only - J & K series

Terminal Duct Kit

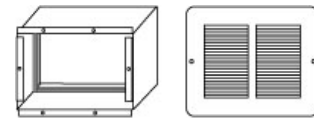

Condenser Baffle Kit

For use on non-baffled grilles. These deflectors direct the air in toward the center and away from the inlet to prevent recirculation of the hot condenser air.

DGK1B	Condenser baffle kit
--------------	----------------------

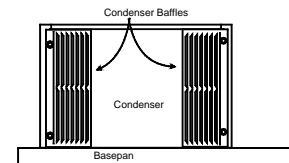

ACCESSORIES (CONT.)

Model #	Heat Stages	Cool Stages	Fan Speed	# of Wires Required	Temp Limiting	Backlit	Display	Type	Shape & Orientation	Connection
DS01G ^{1,2,3}	2	2	2	0	Yes	Yes	Digital	Manual/Energy Management	Square/Vertical	Wireless
DSA02NO ^{1,3}	2	2	2	0	Yes	Yes	Digital	Manual	Rectangular	Wireless
MMW-2 ¹	2	2	2	0	Yes	Yes	Digital	Manual	Rectangular	Wireless
PHWT-A200	2	2	2	7	Yes	Yes	Digital	Programmable/Auto-Change	Square/Vertical	Wired
PWHT-A150H	2	2	2	7	Yes	Yes	Digital	Manual	Square/Vertical	Wired

¹Battery Powered

²Optional hard wired powered capability

³No additional antenna needed for Amana J & K series units. Previous models require DT01G and non-Amana units require GT01H antennas for operation



Hydronic Heat Kit

Add-on kits fit all units, allowing the addition of hydronic water or hydronic steam heat to cooling and heating units. The kits feature left- or right-hand piping. Unit retains complete service access with a kit installed. Unit must be connected to and operated by a wall thermostat.

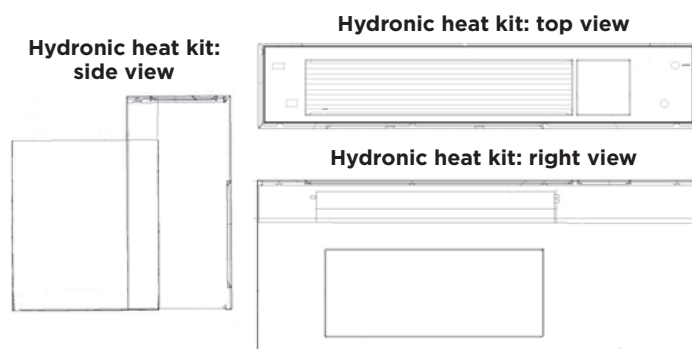
HWK03K	Hydronic water kit - J & K series
HWK03K	Hydronic steam kit - J & K series

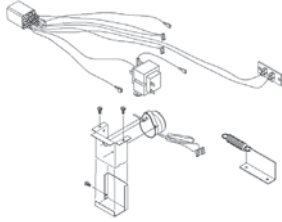

ACCESSORIES (CONT.)

<p>Power Door Kit Vent door will automatically open when unit fan is on. Factory installed feature code - D</p>	<table border="1"> <tr> <td>PK3K</td> <td>230/208V - J & K series</td> </tr> <tr> <td>PK4K</td> <td>265V - J & K series</td> </tr> <tr> <td>PK3E</td> <td>230/208V - R-410A</td> </tr> <tr> <td>PK4E</td> <td>265V - R-410A</td> </tr> </table>	PK3K	230/208V - J & K series	PK4K	265V - J & K series	PK3E	230/208V - R-410A	PK4E	265V - R-410A							
PK3K	230/208V - J & K series															
PK4K	265V - J & K series															
PK3E	230/208V - R-410A															
PK4E	265V - R-410A															
<p>Hydronic Valves Water and steam valves are available for use with the HWK03 (water) and HVK03 (steam) heat kits.</p>	<table border="1"> <tr> <td>VW2WNCA*</td> <td>2-way/24V/NC/end switch</td> </tr> <tr> <td>VW2WNOA*</td> <td>2-way/24V/NO/end switch</td> </tr> <tr> <td>VW3WNC2B*</td> <td>3-way/24V/NC/NO/end switch</td> </tr> </table> <p>PopTop™ actuator</p>	VW2WNCA*	2-way/24V/NC/end switch	VW2WNOA*	2-way/24V/NO/end switch	VW3WNC2B*	3-way/24V/NC/NO/end switch									
VW2WNCA*	2-way/24V/NC/end switch															
VW2WNOA*	2-way/24V/NO/end switch															
VW3WNC2B*	3-way/24V/NC/NO/end switch															
<p>Wireless RF (Radio Frequency) Controls All PTACs come factory-ready for control via wireless RF devices. 2.4 GHz 802.15.4 protocol assures robust communications and response.</p>	<table border="1"> <tr> <td>DS01G</td> <td>Thermostat: 2-way² communications</td> </tr> <tr> <td>DD01E</td> <td>Occupancy sensor: EMS activation²</td> </tr> <tr> <td>DT01G</td> <td>Antenna/router not required for J & K series units</td> </tr> <tr> <td>GT01H</td> <td>Generic radio antenna/router³</td> </tr> <tr> <td>DL01G</td> <td>Web-enabled platform Server link BAC-NET capable</td> </tr> <tr> <td>DR01G</td> <td>Mesh repeater¹</td> </tr> <tr> <td>DL01G SERIAL</td> <td>Serial repeater¹</td> </tr> </table> <p>¹Consult Amana sales representative prior to purchase ²Requires DT01G for use ³Requires DS01G for use</p>	DS01G	Thermostat: 2-way ² communications	DD01E	Occupancy sensor: EMS activation ²	DT01G	Antenna/router not required for J & K series units	GT01H	Generic radio antenna/router ³	DL01G	Web-enabled platform Server link BAC-NET capable	DR01G	Mesh repeater ¹	DL01G SERIAL	Serial repeater ¹	
DS01G	Thermostat: 2-way ² communications															
DD01E	Occupancy sensor: EMS activation ²															
DT01G	Antenna/router not required for J & K series units															
GT01H	Generic radio antenna/router ³															
DL01G	Web-enabled platform Server link BAC-NET capable															
DR01G	Mesh repeater ¹															
DL01G SERIAL	Serial repeater ¹															
<p>Line Voltage/Lighting Control Relay Kit Compatible with Factory Installed Feature Code "L" units. Use these 30A relay in conjunction with our Eden Energy Management System to control any 115 volt circuit based on room occupancy. Relays must be wired and installed during construction or remodel.</p>	<table border="1"> <tr> <td>RKLC10M70</td> <td>10 pack SPDT 24VAC 30A relays</td> </tr> </table>	RKLC10M70	10 pack SPDT 24VAC 30A relays													
RKLC10M70	10 pack SPDT 24VAC 30A relays															
<p>Curtain Baffle Kit The color-matched polymer curtain baffles help prevent curtains from falling into the discharge air stream and causing recirculation, which reduces efficiencies and shortens compressor life.</p>	<table border="1"> <tr> <td>PTCB10K</td> <td>10 pack for J & K series units</td> </tr> <tr> <td>PTCB10E</td> <td>10 pack for R-410A units</td> </tr> </table>	PTCB10K	10 pack for J & K series units	PTCB10E	10 pack for R-410A units											
PTCB10K	10 pack for J & K series units															
PTCB10E	10 pack for R-410A units															

MONTHLY MAINTENANCE

INTAKE AIR FILTERS

It is extremely important to clean the inlet air filters once a month—or more often, if operated in dusty or dirty conditions—to properly maintain the operational performance of the PTAC unit. The two intake air filters, constructed of durable polypropylene, can be easily inserted into the cabinet front using the cabinet filter guides. Before cleaning the intake filters, turn the unit off by setting the mode switch to the OFF position. Filters should be cleaned as required. The following procedure is used to remove the intake filters:

1. Facing the unit, pull up on the filter handles located at the front top of the unit.
2. Pull each filter upward and remove.
3. Clean filters with a vacuum or with running water. Reverse this procedure to reinstall the filters.

Note: Accessory filter kits are available from your salesperson. All filters are permanent and cleanable. Consult your I&O Manual for other monthly cleaning instructions.

Spare Filters

Help keep dirt and lint out of the air and off the coil, thus increasing the unit's efficiency. **Amana** brand filters are easy to remove, wash and replace.

FK10K	10-pack - J & K series
FK10E	10-pack - E & G series



UNIT WITH ACCESSORY WALL SLEEVE AND SUB-BASE ACCESSORY

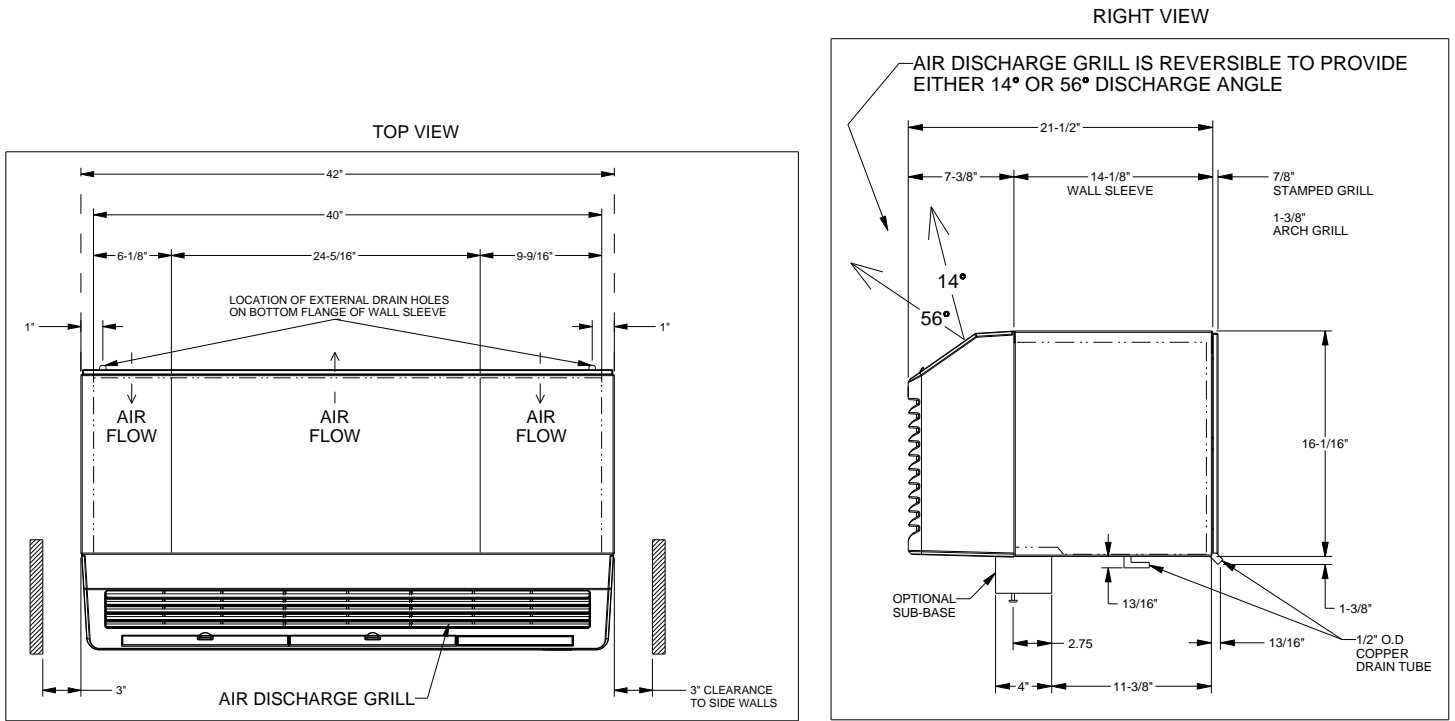

FRONT VIEW
 58" LCDI CORD SET - 230V/208V UNIT*

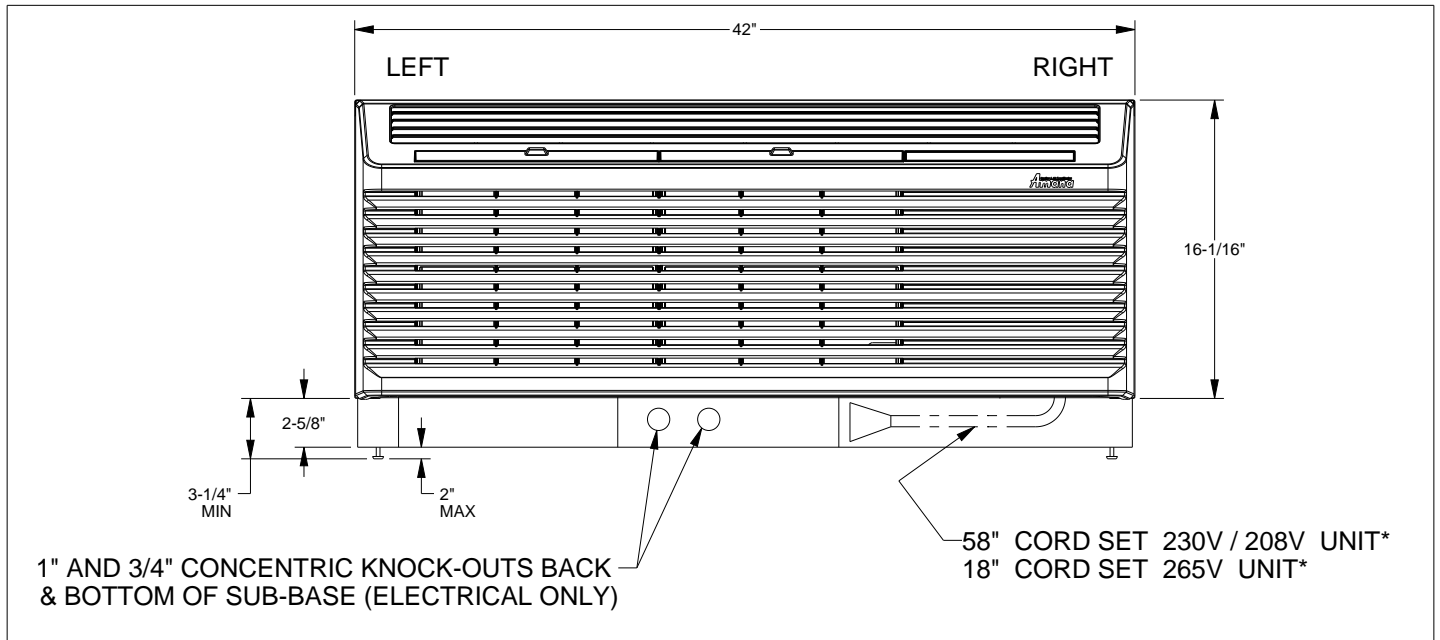

FRAMING FOR ACCESSORY WALL SLEEVE (WS9XX)

Fastening Wall Sleeve

When installed in an opening, the wall sleeve must be horizontally level (side-to-side) and pitched 1/4" bubble to the outside.

(**Note:** If using an internal drain kit, the sleeve must be level from front to back.)

(**Note:** To ensure unit's maximum efficiency, **DO NOT** over- or under-pitch.)

Installation Notes

1. If **sub-base** (PTSB***QW) is installed, allow minimum 3/4" height clearance and maximum 5" height clearance between wall sleeve and floor; allow minimum 2 3/4" protrusion from a finished wall. See Note 4 if using hydronic units.
2. **Drain kit** (DK900QW) is shipped separately. It can be mounted to right side, left side or bottom of sleeve. If mounted to bottom of sleeve, allow 2" height clearance from floor to bottom of sleeve.
3. For UL approval, 265V units must use **Amana** brand **sub-base** (PTSB***QW) or **Amana** brand **hard wire kit** (PSHW04A). Overcurrent protection on 265V units must be provided by cartridge-style time delay fuses, **which are included and factory-installed on the Amana brand 265V chassis**.
4. If **hydronic kit** (HWK03 or HVK03) is installed, **wall sleeve** must extend exactly 3" into the room from the finished interior wall. If using the **Amana** brand **sub-base** (PTSB***QW), only the minimum 3/4" height clearance between wall sleeve and floor is permissible. Unit must also be operated with a remote-mounted thermostat.
5. If **duct kit** (MDK***) is installed, allow a minimum of 2 3/8" into the room from the finished interior wall.

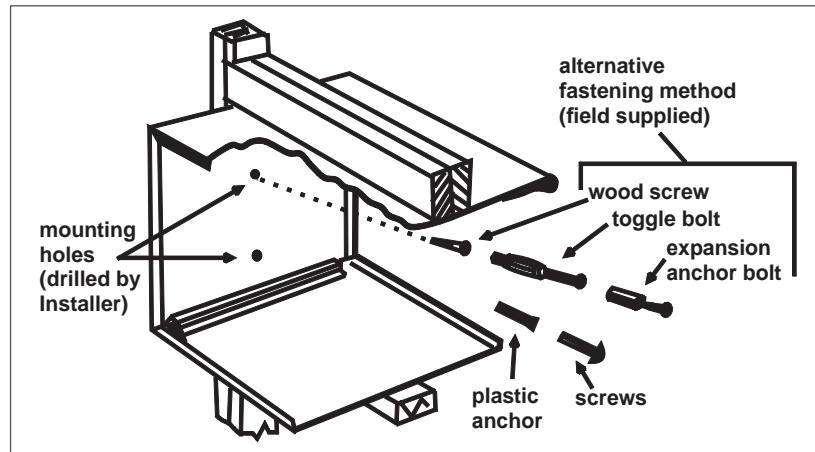

Wall sleeve must extend a minimum of 1/4" beyond outside wall to allow for proper caulking.

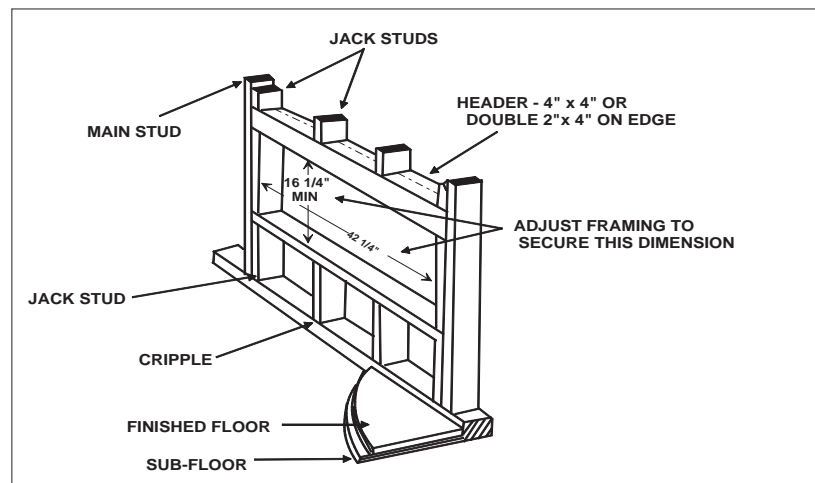

Wall sleeve opening height should be squared with wall sleeve opening width.

H = 16 1/4"

W = 42 1/4"



Complete warranty details available from your dealer or at www.amana-ptac.com.

A LEGACY OF COMFORT



THE IMPECCABLE REPUTATION OF AN AMERICAN ORIGINAL

Amana heating and cooling systems are a part of the enduring legacy of one of America's most recognized and respected brands. Originating eight decades ago in Amana, Iowa, the brand is synonymous with long-lasting, premium-quality products—from home appliances to heating and air conditioning equipment. Chances are, you and generations before you have enjoyed the dependable performance and longevity the **Amana** brand continues to deliver.

CALL YOUR **AMANA** BRAND PTAC SALES REPRESENTATIVE AT 800.647.2982 FOR COMPLETE DETAILS.

Before purchasing this appliance, read important information about its estimated annual energy consumption, yearly operating cost or energy efficiency rating that is available from your retailer.

*Our continuing commitment to quality products may mean a change in specifications without notice. **Amana**® is a registered trademark of Maytag Corporation or its related companies and is used under license. All rights reserved.*

Copyright ©2023 Daikin Comfort Technologies Manufacturing, L.P.