



SHARP

Attention



ENGLISH



AX-1100

MICROWAVE OVEN WITH STEAM AND GRILL
OPERATION MANUAL WITH COOKBOOK

AjMadison
Your Appliance Authority™

800-570-3355

EN

This operation manual contains important information which you should read carefully before using your microwave oven.
IMPORTANT: There may be a serious risk to health if this operation manual is not followed or if the oven is modified so that it operates with the door open.

900 W (IEC 60705)





EN Dear Customer,

Congratulation on acquiring your new appliance, which from now on will make your kitchen chores considerably easier.
 This new multi-purpose oven offers a unique combination of the healthiest cooking methods, all in one versatile appliance: Steam, Grill and Microwave.
 You will be pleasantly surprised by the kinds of things you can do with this appliance. The oven has a variety of cooking options that are separated into automatic and manual settings. Enjoy the convenience of cooking a complete meal all at once.
 In our test kitchen our team has gathered together a selection of the most delicious international recipes which are quick and simple to prepare.
 Be inspired by the recipes we have included and prepare your favourite dishes in your oven.
 We advise you to read the operation manual with cookbook carefully.
 You will then easily understand how to use your oven.

Enjoy using your microwave oven with steam and grill and trying out the delicious recipes.
 Your Sharp Test Kitchen Team

EN CONTENTS

	Page		Page
Operation manual		OTHER CONVENIENT FEATURES.....	EN-17-19
DEAR CUSTOMER.....	1	CLEANING AND CARE.....	EN-20
RECYCLING INFORMATION.....	1	TROUBLESHOOTING CHART.....	EN-21-23
IMPORTANT SAFETY INSTRUCTIONS.....	EN-1-3	SERVICE CALL CHECK.....	EN-24
INSTALLATION.....	EN-4	SPECIFICATIONS.....	EN-25
OVEN DIAGRAM.....	EN-5	Cookbook	
CONTROL PANEL.....	EN-6	COOKING GUIDES.....	EN-26-31
IMPORTANT INSTRUCTIONS.....	EN-7-9	AUTOMATIC COOKING CHART.....	EN-32-40
BEFORE OPERATING.....	EN-10	TABLES FOR MANUAL COOKING.....	EN-41-45
CLEAN THE OVEN BEFORE FIRST USE.....	EN-10	RECIPES.....	EN-46-54
AUTOMATIC COOKING.....	EN-11-12	SERVICE ADDRESSES.....	55-57
MANUAL COOKING.....	EN-13-16		

EN Information on Disposal for Users (private households)



Attention:
 Your product is marked with this symbol. It means that used electrical and electronic products should not be mixed with general household waste. There is a separate collection system for these products.

1. In the European Union

Attention: If you want to dispose of this equipment, please do not use the ordinary dust bin! Used electrical and electronic equipment must be treated separately and in accordance with legislation that requires proper treatment, recovery and recycling of used electrical and electronic equipment.

Following the implementation by member states private households within the EU states may return their used electrical and electronic equipment to designated collection facilities free of charge*. In some countries* your local retailer may also take back your old product free of charge if you purchase a similar new one.

*) Please contact your local authority for further details.

If your used electrical or electronic equipment has batteries or accumulators, please dispose of these separately beforehand according to local requirements.

By disposing of this product correctly you will help ensure that the waste undergoes the necessary treatment, recovery and recycling and thus prevent potential negative effects on the environment and human health which could otherwise arise due to inappropriate waste handling.

2. In other Countries outside the EU

If you wish to discard this product, please contact your local authorities and ask for the correct method of disposal.

For Switzerland: Used electrical or electronic equipment can be returned free of charge to the dealer, even if you don't purchase a new product. Further collection facilities are listed on the homepage of www.swico.ch or www.sens.ch.



IMPORTANT SAFETY INSTRUCTIONS

IMPORTANT SAFETY INSTRUCTIONS: READ CAREFULLY AND KEEP FOR FUTURE REFERENCE

This oven is designed to be used on a countertop only. It is not designed to be built into a kitchen unit. Do not place the oven in a cabinet.

The oven door may become hot during cooking. Place or mount the oven so that the bottom of the oven is 85 cm or more above the floor. Keep children away from the door to prevent them burning themselves.

Ensure there is a minimum of free space above the oven of 12 cm.

This appliance is not intended for use by persons (including children) with reduced physical, sensory or mental capabilities, or lack of experience and knowledge, unless they have been given supervision or instruction concerning use of the appliance by a person responsible for their safety.

Children should be supervised to ensure that they do not play with the appliance.

WARNING: Only allow children to use the oven without supervision when adequate instructions have been given so that the child is able to use the oven in a safe way and understands the hazards of improper use.

WARNING: When the appliance is operated in the GRILL, COMBI, STEAM and AUTOMATIC operations (except AUTO DEFROST MENUS), children should only use the oven under adult supervision due to the temperature generated.

WARNING: Accessible parts may become hot during use. Young children should be kept away.

WARNING: If the door or door seals are damaged, the oven must not be operated until it has been repaired by a competent person.

WARNING: Never adjust, repair or modify the oven yourself. It is hazardous for anyone other than a competent person to carry out any service or repair operation which involves the removal of a cover which gives protection against exposure to microwave energy.

If the power supply cord of this appliance is damaged, it must be replaced with a special cord. The exchange must be made by an authorised SHARP service agent.

WARNING: Liquids and other foods must not be heated in sealed containers since they are liable to explode. Microwave heating of beverages can result in delayed eruptive boiling, therefore care must be taken when handling the container.

Do not cook eggs in their shells, and whole hard boiled eggs should not be heated in microwave ovens since they may explode even after microwave cooking has ended. To cook or reheat eggs which have not been scrambled or mixed, pierce the yolks and the whites, or the eggs may explode. Shell and slice hard boiled eggs before reheating them in the microwave oven.

Utensils should be checked to ensure that they are suitable for use in the oven. See Page EN-27. Use only microwave safe containers and utensils on microwave modes.

The contents of feeding bottles and baby food jars must be stirred or shaken and the temperature checked before consumption, in order to avoid burns.

The door, outer cabinet, oven cavity, dishes, accessories and especially the grill heating elements will become very hot during operation. Care should be taken to avoid touching these areas. To prevent burns, always use thick oven gloves. Before cleaning make sure they are not hot.

When heating food in plastic or paper containers, keep an eye on the oven due to the possibility of ignition. If smoke is observed, switch off or unplug the oven and keep the door closed in order to stifle any flames.

Clean the oven at regular intervals and remove any food deposits.

Failure to maintain the oven in a clean condition could lead to deterioration of the surface that could adversely affect the life of the appliance and possibly result in a hazardous situation.

Do not use harsh abrasive cleaners or sharp metal scrapers to clean the oven door glass since they can scratch the surface, which may result in shattering of the glass.

Steam cleaner is not to be used.

See instructions for cleaning door seals, cavities and adjacent parts on page EN-20.

To avoid the danger of fire.

No other liquid than room temperature water suitable for drinking (filtered) can be poured into the water tank.

The microwave oven should not be left unattended during operation. Power levels that are too high, or cooking times that are too long, may overheat foods resulting in a fire.

The electrical outlet must be readily accessible so that the unit can be unplugged easily in an emergency.

The AC power supply must be 230V, 50Hz, with a minimum 16A distribution line fuse, or a minimum 16A distribution circuit breaker.

A separate circuit serving only this appliance should be provided.



IMPORTANT SAFETY INSTRUCTIONS

Do not place the oven in areas where heat is generated. For example, close to a conventional oven. Do not install the oven in an area of high humidity or where moisture may collect.

Do not store or use the oven outdoors.

Clean the oven cavity and the oven floor after use. These must be dry and free from grease. Built-up grease may overheat and begin to smoke or catch fire.

Do not place flammable materials near the oven or ventilation openings.

Do not block the ventilation openings.

Remove all metallic seals, wire twists, etc., from food and food packages. Arcing on metallic surfaces may cause a fire.

Do not use the microwave oven to heat oil for deep frying. The temperature cannot be controlled and the oil may catch fire.

To make popcorn, use only special microwave popcorn makers.

Do not store food or any other items inside the oven. Check the settings after you start the oven to ensure the oven is operating as desired.

To avoid overheating and fire, special care must be taken when cooking or reheating foods with a high sugar or fat content, for example, Sausage rolls, Pies or Christmas pudding.

See the corresponding hints in operation manual and the cookery book section.

When alcoholic beverage are added when roasting or cooking cakes and sweets, there is a risk that vapours released by the alcohol may catch fire upon coming into contact with the electrical heating element. Attend the oven closely during cooking.

To avoid the possibility of injury

WARNING:

Do not operate the oven if it is damaged or malfunctioning. Check the following before use:

- The door; make sure the door closes properly and ensure it is not misaligned or warped.
- The hinges and safety door latches; check to make sure they are not broken or loose.
- The door seals and sealing surfaces; ensure that they have not been damaged.
- Inside the oven cavity or on the door; make sure there are no dents.
- The power supply cord and plug; ensure that they are not damaged.

Do not operate the oven with the door open or alter the door safety latches in any way.

Do not operate the oven if there is an object between the door seals and sealing surfaces.

Do not allow grease or dirt to build up on the door seals and adjacent parts. Clean the oven at regular intervals and remove any food deposits. Follow the instructions for "Cleaning and Care" on page EN-20.

Individuals with PACEMAKERS should check with their doctor or the manufacturer of the pacemaker for precautions regarding microwave ovens.

To avoid the possibility of electric shock

Under no circumstances should you remove the outer cabinet.

Never spill or insert any objects into the door lock openings steam outlets or ventilation openings. In the event of a spill, turn off and unplug the oven immediately, and call an authorised SHARP service agent.

Do not immerse the power supply cord or plug in water or any other liquid.

Do not let the power supply cord hang over the edge of a table or work surface.

Keep the power supply cord away from heated surfaces, including the rear of the oven.

Do not attempt to replace the oven lamp yourself or allow anyone who is not an electrician authorised by SHARP to do so. If the oven lamp fails, please consult your dealer or an authorised SHARP service agent.

To avoid the possibility of explosion and sudden boiling:

Never use sealed containers. Remove seals and lids before use. Sealed containers can explode due to a build up of pressure even after the oven has been turned off.

Take care when microwaving liquids. Use a wide-mouthed container to allow bubbles to escape.

Never heat liquids in narrow necked containers such as baby bottles, as this may result in the contents erupting from the container when heated and cause burns.

To prevent sudden eruption of boiling liquid and possible scalding:

- Do not use excessive amount of time (See page EN-41).
- Stir liquid prior to heating/reheating.
- It is advisable to insert a glass rod or similar utensil (not metal) into the liquid whilst reheating.
- Let liquid stand for at least 20 seconds in the oven at the end of cooking time to prevent delayed eruptive boiling.

Pierce the skin of such foods as potatoes, sausages and fruit before cooking, or they may explode.

To avoid the possibility of burns

CAUTION HIGH TEMPERATURE



This symbol means that the top surface becomes hot during operation and it should not be touched with bare hands and no material should be placed on it at any time.

Use pot holders or oven gloves when removing food from the oven to prevent burns.





IMPORTANT SAFETY INSTRUCTIONS

Use care when opening door. To avoid burns from escaping heat and steam, let hot air or steam escape before removing or replacing food.

Always open containers, popcorn makers, oven cooking bags, etc., away from the face and hands to avoid steam burns and eruption of boiling.

To avoid burns, always test food temperature and stir before serving and pay special attention to the temperature of food and drink given to babies, children or the elderly.

Temperature of the container is not a true indication of the temperature of the food or drink; always check the food temperature.

Always stand back from the oven door when opening it to avoid burns from escaping steam and heat.

Slice stuffed baked foods after heating to release steam and avoid burns.

To avoid misuse by children

Do not lean or swing on the oven door.

Children should be taught all important safety instructions: use of pot holders, careful removal of food coverings; paying special attention to packaging (e.g. self-heating materials) designed to make food crisp, as they may be extra hot.

Other warnings

Never modify the oven in any way.

Do not move the oven while it is in operation.

This oven is for home food preparation only and may only be used for cooking food. It is not suitable for commercial or laboratory use.

To promote troublefree use of your oven and avoid damage.

Never operate the oven when it is empty except where recommended in the operation manual.

Doing so may damage the oven.

When using a browning dish or self-heating material, always place a heat-resistant insulator such as a porcelain plate under it to prevent damage to the oven floor due to heat stress.

The preheating time specified in the dish's instructions must not be exceeded.

Do not use metal utensils, which reflect microwaves and may cause electrical arcing.

Do not place anything on the outer cabinet during operation.

When the oven is in use, ventilate a room where the oven is installed. e.g. open a window or switch a kitchen ventilation.

Do not operate the oven if water tank cracks and water leaks. Please consult your dealer or an authorised SHARP service agent.

To prevent condensation which could corrode the appliance, do not leave cooked food in the oven for an extended period. Clean the oven at regular intervals and remove any food deposits in the oven or on the door.

Do not insert fingers or objects in the holes (the steam outlets or air-vent openings) as this may damage the oven and cause an electric shock or a hazard.

Do not touch the electric plug with wet hand. Plug into the electric wall socket securely. When removing the plug from the socket always grip the plug, never pull the power supply cord as this may damage the power supply cord and the connections inside the plug.

Never move the oven in operating. If the oven needs to be moved, always drain all water inside the oven using DRAIN WATER function. After draining, empty the drip tray.

Do not water the door or control panel intentionally.

If the oven falls down or drops on the floor, do not use the oven. Unplug and contact your dealer or an authorised SHARP Service Agent.

NOTE:

If you are unsure how to connect your oven, please consult an authorised, qualified electrician. Neither the manufacturer nor the dealer can accept any liability for damage to the oven or personal injury resulting from failure to observe the correct electrical connection procedure.

Water vapour or drops may occasionally form on the oven walls or around the door seals and sealing surfaces. This is a normal occurrence and is not an indication of microwave leakage or a malfunction.



INSTALLATION

1. Remove all packing materials from the inside of the oven cavity. Discard the loose polythene sheet from between the door and cavity. Remove the feature sticker, if attached, from the outside of the door.
2. Check the oven carefully for any signs of damage.
3. Place the oven on a flat, level surface strong enough to support the oven's weight plus the heaviest item likely to be cooked.
This oven is designed for countertop use only. Steam is ventilated from the bottom of the oven. Make sure the escaping steam does not wet electrical outlets/other electrical appliances.
4. Place or mount the oven so that the bottom of the oven is 85 cm or more above the floor.
5. **Do not allow the power supply cord to run over any hot or sharp surfaces, such as the hot air vent area at the bottom of the oven.**
6. Ensure there is a minimum of free space above the oven of 12 cm.
7. Securely connect the plug of the oven to a standard earthed (grounded) household electrical outlet.





OVEN DIAGRAM

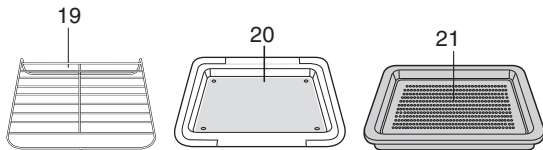
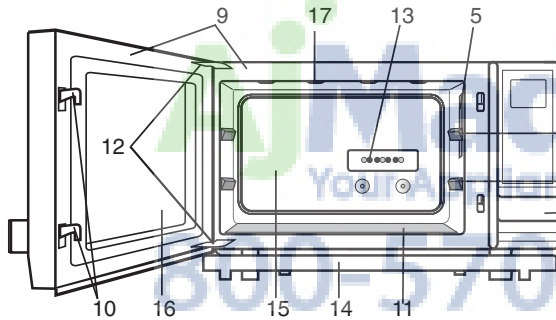
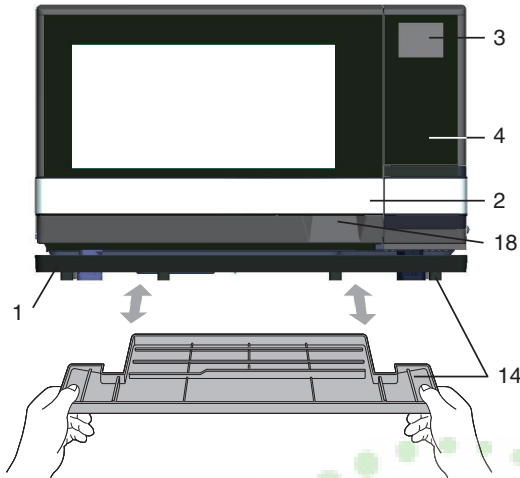

NOTE:

Place the rack on glass tray as shown in Figure 1.

WARNING:

The oven cavity, door, outer cabinet, accessories and dishes will become very hot, use thick dry oven gloves when removing the food or accessories from the oven to prevent burns.

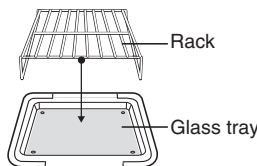

Figure 1

Oven glove

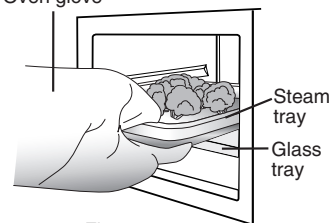

Figure 2

- 1** Ventilation openings (at the bottom of the oven)
Be aware that hot steam or air comes out during steam or combi cooking, and keep children away from the oven.
- 2** Door open handle
- 3** LCD display
- 4** Control panel
- 5** Oven lamp
- 6** Upper position (position 3)
- 7** Lower position (position 2)
- 8** Water tank (See page EN-7.)
- 9** Door seals and sealing surfaces
- 10** Latch
- 11** Oven floor (position 1)
- 12** Door hinges
- 13** Steam outlets
- 14** Drip tray (See page EN-7.)
- 15** Oven cavity
- 16** See through door
- 17** Grill heating element (at the oven cavity ceiling)
- 18** Door lever
To open, grip the door lever from the bottom and pull it towards you.

ACCESSORIES

- 19** Rack
For Grill and Combi.
Do not use for Steam and Microwave. Always place on glass tray.
- 20** Glass tray
- 21** Steam tray x2
For Steam only.
Always place above/on glass tray.
Do not use for Microwave, Grill and Combi.

WARNING for stacking the steam tray and glass tray:

After cooking, take out the steam tray first. See figure 2. Be aware of excess water from the steam tray, we recommend you place it directly on a flat dish or tray to avoid spillages.

Before taking out the glass tray, make sure that it is cool. Be aware that there may be water on the glass tray, so take care when removing it.



ENGLISH



CONTROL PANEL

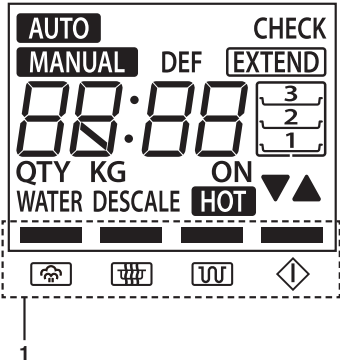

Display information:

The display shows useful information including cooking time and cooking mode.

1. Cooking mode & START indicators

The indicator, just above each symbol, will flash or light up during the operation.

You can press a concerned key when the indicators are flashing. When the indicators light up on the display, they mean that each cooking mode is selected or the oven is operating in each cooking mode.

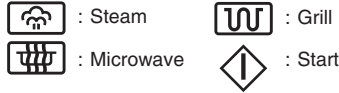

AUTO: Automatic cooking is selected or in progress.

MANUAL: Manual cooking is selected or in progress.

CHECK: Some action is necessary (e.g. turn over, stir).

DEF: Steam Defrost or Auto Defrost Menus is selected or in progress.

ON: The oven is in operation.

EXTEND: Cooking time can be extended.

HOT: The oven is very hot.

▲ (MORE): More time adjustment is selected for automatic cooking.

▼ (LESS): Less time adjustment is selected for automatic cooking.

DESCALE: Descaling is necessary.

WATER: Water is necessary. When this indicator is appeared on the display, the oven is operating in the menu using water.



Tray position indicators:

The position of the tray(s) for automatic cooking and manual steam cooking.

3: Upper position

2: Lower position

1: Oven Floor

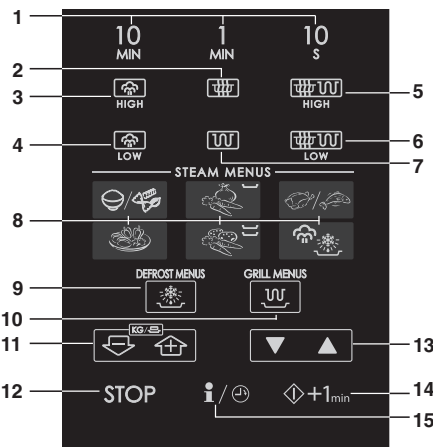

Operating keys:

- 1 TIME keys
- 2 MICROWAVE POWER LEVEL* key
- 3 STEAM HIGH key
- 4 STEAM LOW key
- 5 COMBI HIGH* key
- 6 COMBI LOW* key
- 7 GRILL* key
- 8 STEAM MENU keys
- 9 AUTO DEFROST MENU* key
- 10 AUTO GRILL MENU* key
- 11 WEIGHT DOWN/UP keys
- 12 STOP/CLEAR key
- 13 LESS/MORE keys
- 14 START ◊/+1min (START/AUTO MINUTE) key
- 15 INFO/KITCHEN TIMER key

* This mode does not use steam.



IMPORTANT INSTRUCTIONS

Read Carefully Before Cooking with Steam

WATER TANK

To fill the water tank with room temperature water suitable for drinking (filtered) is a must for cooking with steam. Be sure to follow the directions below.

1. Pull the water tank toward you to remove. (Figure 1)
2. Wash the water tank and lid for the first time.
3. Fill the water tank with **room temperature water suitable for drinking (filtered) through the lid to the MAX mark each time you begin to cook.** (Figure 2) Do not fill the water tank over the MAX mark.
4. Make sure the lid is closed firmly.
5. Install the water tank by pushing firmly. (Figure 3)
6. After cooking, empty the water tank and wash the water tank and the lid.

NOTES:

1. Do not use any other liquids like distilled water, R.O water, mineral water and etc.
2. An insufficient amount of water in the water tank may cause an undesired result.
3. We recommend that you empty the water tank every time after cooking. Do not leave the water tank filled with water in the oven over a day.
4. If "Err, WATER (flashing)" is shown in the display during Steam cooking, refer to Troubleshooting Chart on page EN-21. The message will not appear in Descale function.
5. Do not drop or damage the water tank. Heat may cause the water tank to change shape. Do not use a damaged water tank. Consult your dealer or an authorised SHARP service agent.
6. There may be a few water drops when removing the water tank. Wipe the oven dry with a soft cloth.
7. Do not block the air holes on the lid of the water tank. It will cause trouble during cooking.

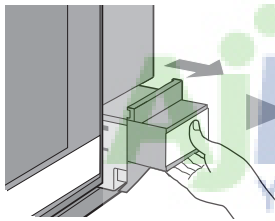

Figure 1

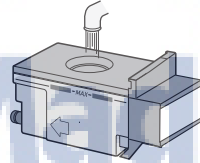

Figure 2

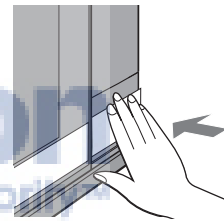

Figure 3

DRIP TRAY

Be sure to cook with drip tray in position and follow the directions below.

The drip tray is packed with the oven. Place the drip tray under the oven door as shown in Figure 4. This drip tray collects the condensation from the oven door.

To remove the drip tray: Pull the drip tray toward you with both hands.

* Make sure water is not dripping down before removing the drip tray.

To replace the drip tray: Place the drip tray onto the right and left hooks under the oven and push firmly as shown in Figure 4. Insert the drip tray horizontally when you attach it. Improper use may cause the damage to the hooks.

Empty the drip tray after each time you cook. Empty, rinse thoroughly, dry and replace. Failure to empty may cause the drip tray to overflow. Cooking repeatedly without emptying the drip tray may cause it to overflow.

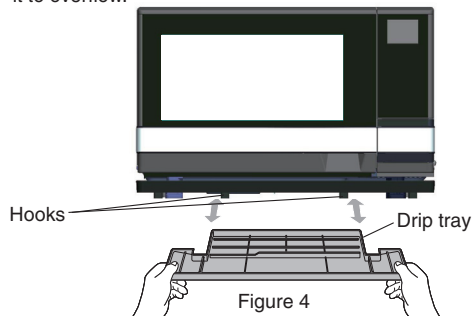

Figure 4

WARNINGS:

1. The oven will become very hot after cooking and draining water function.
2. Do not open the oven with your face close to the oven. Steam from the oven may cause burns.
3. Make sure that the oven has cooled before emptying the water tank and the drip tray and then wipe the oven cavity.
4. Do not touch the water directly as water in the drip tray may be hot.



IMPORTANT INSTRUCTIONS

Steam in Automatic and Manual Cooking

Before cooking

1. Make sure the water tank is filled with room temperature water suitable for drinking (filtered) and is installed. (See page EN-7.)
2. Make sure the empty drip tray is installed. (See page EN-7.)
3. Place food in the oven. Make sure to place the glass tray in lower position (position 2) for cooking with steam mode.

After Cooking

1. After the oven has cooled, remove and empty the water tank, wipe oven cavity. Be aware that the grill heating element and steam outlets may be still hot, so take care when wiping the ceiling and cavity back plate. (The grill heating element will turn on for a very short time before the end of the cooking.) Empty the drip tray.
2. Perform the Drain Water function at least once a day after using Steam Menus, Steam High or Steam Low.
3. Check that water is not dripping down before removing the drip tray, as a small amount of water drains into the drip tray when the water tank is removed.
4. During and after cooking, condensed water may be on the door, oven walls and oven floor. Dry any liquid residue with a soft cloth. After the last use of the day, we recommend to operate the oven with Grill for 3 minutes without food and accessories for drying the water off around grill heating element.

WARNING: Do not open the oven with your face close to the oven. Steam from the oven may cause burns.

NOTE: Keep the door closed. If opened during cooking, steam will escape and a longer cooking time will be required.

AjMadison
Your Appliance Authority™
800-570-3355



IMPORTANT INSTRUCTIONS

Drain Water Function

Perform the Drain Water function at least once a day after cooking with steam. It takes up to 7 minutes.

Drain Water function is very useful to prevent scale build up and the use of stale water. It causes evaporation of the internal steam system.

PROCEDURE

- 1** Remove the water tank. Ensure that no food is in the oven. Press **INFO/KITCHEN TIMER** once to select "In F1".  x 1
- 2** Press **START**  /+1min. "In F1" will flash on and off in the display during the Drain Water function.  +1min x 1
- 3** When the drain function has ended and the oven is cool, wipe oven cavity. Empty the drip tray.

NOTES:

- The water tank must be removed before starting this procedure.
- If Drain Water Function is set, Energy Save Mode will be cancelled temporary.

Descale Function

White or gray grains, also called scale, may form in the water circuit inside the oven during steam generation, which could cause the oven to malfunction.

When "DESCALE (flashing)" is shown in the display, be sure to carry out Descale function immediately. It takes about 1 hour. (The descaling using citric acid or lemon juice is for about 30 minutes, and then rinsing with fresh water is for about 30 minutes.)

PROCEDURE

- 1** Pure citric acid, available at some drugstores, or bottled 100% lemon juice with no pulp are used for descaling. Choose one and prepare the descaling solution.
To use pure citric acid, dissolve 1 tablespoon of pure citric acid crystals in 500ml of water in a non-porous container. Stir well and pour into the water tank to the MAX mark.
To use 100% bottled lemon juice, check that there is absolutely no pulp in it. If there is pulp or you are not sure, strain through a fine strainer. Measure 70ml of the strained lemon juice and add it to 500ml of water. Stir well and pour into the water tank to the MAX mark.
Place the water tank in the oven correctly and push firmly into place.

- 2** Press **INFO/KITCHEN TIMER**

twice to select "In F2".

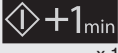
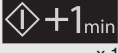

- 3** Place the glass tray in lower position (position 2) closely to attach to the back side of the oven wall.

- 4** Do not place any food in the oven. Close the door firmly. Press **START**  /+1min to begin descaling. (about 30 min.)  +1min x 1

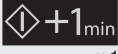
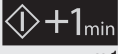
- 5** When the oven has stopped and is cool, remove water tank, empty, rinse and refill with room temperature water suitable for drinking (filtered) to the MAX mark. Replace the water tank. Empty the drip tray and replace it. Remove glass tray, empty, rinse and dry. Follow step 3 to replace glass tray. Close the door firmly. Press **START**  /+1min. Rinsing will start. (about 30 min.)  +1min x 1

- 6** When rinsing has ended and the oven is cool, remove water tank and empty. Remove glass tray and empty. Wipe oven cavity to dry. Empty the drip tray.

NOTE:

If Descale Function is set, Energy Save Mode will be cancelled temporary.

ENGLISH



BEFORE OPERATING

- Before operating your oven, make sure you read and understand this operation manual completely.
- Before the oven can be used, follow these procedures:
 1. Place the drip tray correctly. See page EN-7.
 2. See below for getting started.
 3. Follow directions on the right side for clean the oven before first use.

Getting Started

Your oven has an Energy Save Mode. This facility saves electricity when the oven is not in use.

PROCEDURE

- 1** Plug the oven into a power point. Nothing will appear on the display at this time.
- 2** Open the door. The display will show ".0".
- 3** Close the door. Now you can ready to use the oven.

CAUTION:

In Energy Save Mode, if you do not operate the oven for 3 minutes or more (i.e. after closing the door, or pressing **STOP/CLEAR**, or at the end of cooking), you will not be able to operate the oven until you open and close the oven door.

NOTE:

When you set Child Lock or Demonstration Mode, Energy Save Mode will be cancelled temporary.

STOP/CLEAR

1. Press **STOP/CLEAR** if you make a mistake during programming.
2. Stop the oven temporarily during cooking.
3. Cancel a programme during cooking, press twice.

CLEAN THE OVEN BEFORE FIRST USE



You may detect smoke or a burning smell when using the grill for the first time, this is normal and not a sign that the oven is out of order. To avoid this problem, when first using the oven, operate the grill without food for 20 minutes.

PREPARATION

Ventilate the room.

PROCEDURE

- 1** Ensure that no food is in the oven. Enter the time by pressing **TIME** (20.00). 

- 2** Press **GRILL** and **START**  
 x 1 x 1

WARNING:

The oven door, outer cabinet, oven cavity and especially the grill heating element will become hot.



AUTOMATIC COOKING

Automatic Operation is cooked with steam, grill and microwave function. Refer to each function for the details.

Steam Menu

Steam Menu has 6 categories and 18 menus. Always cook food using steam tray and glass tray. Ensure the glass tray is on the lower position (position 2.) And see the important instructions on page EN-7-8.

St11 - St14: Rice/Pasta/Egg
 St21 - St25: Vegetable 1 layer
 St31 - St32: Fish/Chicken
 St41 - St42: Balanced Menus
 St51 - St52: Vegetable 2 layers (vegetable + potato)
 Sd1 - Sd3: Steam Defrost

Refer to the Steam Menu Guide for details on page EN-32-37.

* Suppose you want to cook 0.3 kg of Chicken Fillets.

PROCEDURE

1 Make sure the water tank is filled to the MAX mark with room temperature water suitable for drinking (filtered) and is installed. Press **FISH/CHICKEN** until desired menu number is displayed (St32).



2 Enter the weight or quantity by pressing **WEIGHT** until the desired weight or quantity is displayed (0.3 kg).

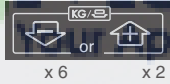

3 Place food in oven by following the directions in the cooking guide on page EN-33. Close the door. Press **START** \diamond /+1min.

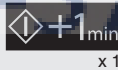

4 After cooking, **EXTEND** will appear. If you wish to extend cooking time, enter the desired time by pressing **TIME**. Press **START** \diamond /+1min. If not, press **STOP/CLEAR**. After the oven has cooled, remove and empty the water tank, wipe oven cavity. Empty the drip tray.

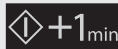
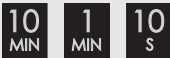

WARNING for stacking the steam tray and glass tray:

After cooking, take out the steam tray first. See Figure 2 on page EN-5. Be aware of excess water from the steam tray, we recommend you place it directly on a flat dish or tray to avoid spillages.

Before taking out the glass tray, make sure that it is cool. Be aware that there may be water on the glass tray, so take care when removing it.

NOTES:

1. Enter the weight or amount of the food only. Do not include the weight of the container.
2. For foods weighing more or less than weights given in the cooking charts, cook manually.
3. The programmed cooking times are average times. To extend cooking times preprogrammed in the automatic cooking, see **EXTENDING COOKING TIME AT THE END OF STEAM COOKING** on page EN-17. Before extending the cooking time, make sure the water tank is filled to the MAX mark with room temperature water suitable for drinking (filtered) and is installed.
4. Any Steam selection can be programmed with More or Less Time Adjustment. See page EN-17.
5. Keep the door closed. If opened during cooking, steam will escape and a longer cooking time will be required.
6. The amount of water in the water tank is sufficient for one cooking operation: Water does not need to be added during cooking.
7. During and after cooking, condensed water may be on the door, oven walls and oven floor. Dry any liquid residue with a soft cloth. After the last use of the day, we recommend to operate the oven with Grill for 3 minutes without food for drying the water off around grill heating element.
8. After cooking, the oven will automatically cool and you will hear the sound of the cooling fan. The fan may continue to operate up to 10 minutes depending on the oven and parts temperature.

WARNINGS:

1. The oven door, outer cabinet, oven cavity, accessories, dishes and especially the grill heating element will become hot. Use thick oven gloves when adding or removing foods to prevent burns.
2. Do not open the oven with your face close to the oven. Steam from the oven may cause burns.

NOTE for St13, St14 and Sd3:

It is not necessary to enter amount. Skip the step2.

NOTE for Steam Defrost (Sd1-Sd3):

They are defrosted with Steam and Microwave. Do not use the glass tray, steam tray and metal rack.

AUTOMATIC COOKING

Auto Grill Menus



Auto Grill Menus has 4 menus.

AG1: Chicken Legs AG3 : Fish Gratin
AG2: Grill Chicken AG4 : Grill Skewers

Refer to the Auto Grill Menu Guide for details on page EN-38-39.

* Suppose you want to cook 0.4kg of Chicken Legs.

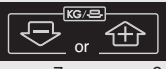
PROCEDURE

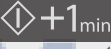
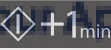
- 1 Press **AUTO GRILL MENUS** until desired menu number is displayed (AG1).  x 1
- 2 Enter the weight by pressing **WEIGHT** until the desired weight is displayed (0.4kg).  x 7  x 3
- 3 Place food in the oven by following the directions in the cooking guide on page EN-38. Close the door. Press **START**  /+1min. x 1
- 4 The oven will stop and **CHECK** will flash on and off. Open the door. Turn over the chicken legs.  /+1min. x 1

NOTES:

1. Enter the weight of the food only. Do not include the weight of the container.
2. For foods weighing more or less than weights given in the cooking charts, cook manually.
3. Always follow the instructions in the cooking guide.
4. All selections can be programmed with More or Less Time Adjustment. See page EN-17.
5. After cooking, the oven will automatically cool and you will hear the sound of the cooling fan. The fan may continue to operate up to 10 minutes depending on the oven and parts temperature.

WARNING:

The oven door, outer cabinet, oven cavity, accessories, dishes and especially the grill heating element will become hot. Use thick oven gloves when adding or removing foods to prevent burns.

Auto Defrost Menus



Auto Defrost Menu has 4 menus. Do not use the glass tray, steam tray and metal rack.

dE1: Steak/Chops
dE2: Minced Meat
dE3: Poultry
dE4: Bread

Refer to the Auto Defrost Menu Guide for details on page EN-40.

* Suppose you want to defrost a 0.5 kg steak.

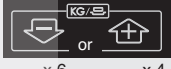
PROCEDURE

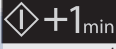
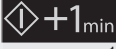
- 1 Press **AUTO DEFROST MENUS** until desired menu number is displayed (dE1).  x 1
- 2 Enter the weight by pressing **WEIGHT** until the desired weight is displayed (0.5 kg).  x 6  x 4
- 3 Place food in oven by following the directions in the cooking guide on page EN-40. Close the door. Press **START**  /+1min. x 1
- 4 The oven will stop and **CHECK** will flash on and off. Open the door. Turn over the steak and shield the defrosted portions. Close the door. Press **START**  /+1min. x 1

NOTES:

1. Enter the weight of the food only. Do not include the weight of the container.
2. Any defrost selection can be programmed with More or Less Time Adjustment. See page EN-17.
3. To defrost other foods or foods above or below the weights allowed on Auto Defrost Menu Guide, use time and 30% microwave power. See Microwave on page EN-16.
4. Do not use the glass tray, steam tray and metal rack.
5. After cooking, the oven will automatically cool and you will hear the sound of the cooling fan. The fan may continue to operate up to 10 minutes depending on the oven and parts temperature.



MANUAL COOKING

Manual Cooking is an option in Steam, Grill, Combi and Microwave.
Refer to the "Manual Cooking Chart" and "Food and Utensil Position Chart". The charts give information on each setting.

Manual Cooking Chart

Cooking mode		Temp/power range	Time range	Water tank
Steam	High	100 °C	0 - 35 min.	YES
	Low	70 - 95°C *	0 - 60 min.	YES
Grill		–	0 - 99 min. 50 sec.	NO
Combi	High	Grill: 100% power Microwave: 10 - 70% power	0 - 99 min. 50 sec.	NO
	Low	Grill: 50% power Microwave: 10 - 70% power	0 - 99 min. 50 sec.	NO
Microwave		0 - 100% power	0 - 99 min. 50 sec.	NO

* You can set the temperature from 70°C to 95°C in multiples of 5°C. (Initial setting: 90°C)

Food and Utensil Position Chart

Cooking mode	2 layer cooking		Food and utensil position (Refer to Figure 1.)		
			3: Upper	2: Lower	1: Oven floor
Steam	High	YES	1 layer	Food Steam tray	—
		2 layers	Food Steam tray	Food Steam tray Glass tray	—
	Low	NO	Food Steam tray	Glass tray (No food)	—
Grill		NO	Food	Rack or dish	—
Combi	High	NO	Food	Glass tray	See NOTE 1.
	Low	NO	Food	Glass tray	See NOTE 1.
Microwave		NO	—	Food Microwave safe container Glass tray	Food Microwave safe container

NOTES:

- Select desired position depending on the food size. Position 2 or position 3 is recommended for most recipes. Place the food and glass tray on position 1 when roasting big portions to prevent touching the food to the oven ceiling. Smoke will occur during the cooking if the food touches the grill heating element.
- For cooking cake or meatloaf.
- Do not leave the steam tray and rack wet after use.

WARNING for stacking the steam tray and glass tray:

After cooking, take out the steam tray first. See Figure 2. Be aware of excess water from the steam tray, we recommend you place it directly on a flat dish or tray to avoid spillages. Before taking out the glass tray, make sure that it is cool. Be aware that there may be water on the glass tray, so take care when removing it.

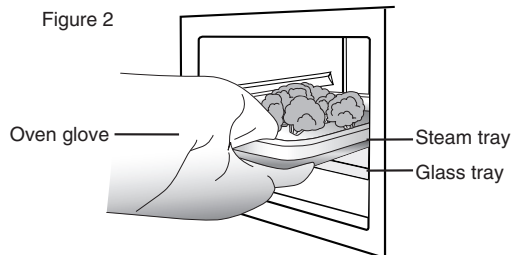
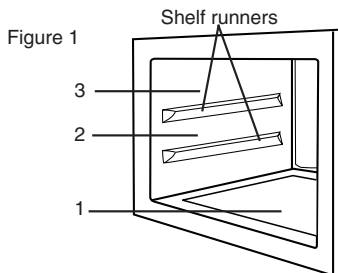



EN - 13

MANUAL COOKING

Steam

Manual Steam has 2 options, Steam High and Steam Low. Always cook food using steam tray and glass tray. See page EN-13 for the details. And see the important instructions on page EN-7-8.

Cooking mode	Temperature
Steam High 	100°C
Steam Low 	70 - 95°C

Use Steam High to steam foods such as chicken or vegetables. Use Steam Low to steam fish or egg custard gently. With Steam Low mode, cooking time is a little longer than Steam High mode. Steam cooks food gently without destroying shape, colour or aroma. The Steam High can be programmed for up to 35 minutes (35.00). The Steam Low can be programmed for up to 60 minutes (60.00). On Steam Low, the temperature can be set between 70°C and 95°C by 5°C step. 2 layers cooking is available for Steam High. 1 layer cooking only is available for Steam Low.

STEAM HIGH

* Suppose you want to cook for 20 minutes on Steam High with 2 layers.



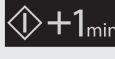



PROCEDURE

- 1 Make sure the water tank is filled to the MAX mark with room temperature water suitable for drinking (filtered) and is installed. Enter the desired cooking time by pressing **TIME** (20.00).  x 2
- 2 Press **STEAM HIGH** until the desired tray position indicators are displayed (2 and 3).  x 2
- 3 Press **START**  /+1min.  x 1
- 4 After cooking, **EXTEND** will appear. If you wish to extend cooking time, enter the desired time by pressing **TIME** and press **START**  /+1min.  If not, press **STOP/CLEAR**. After the oven has cooled, remove and empty the water tank, wipe oven cavity. Empty the drip tray. 

STEAM LOW

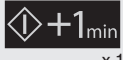
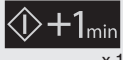
* Suppose you want to cook for 20 minutes on Steam Low (80°C).

PROCEDURE

- 1 Make sure the water tank is filled to the MAX mark with room temperature water suitable for drinking (filtered) and is installed. Enter the desired cooking time by pressing **TIME** (20.00).  x 2
- 2 Press **STEAM LOW** until the desired temperature is displayed (80°C).  x 3
- 3 Press **START**  /+1min.  x 1
- 4 After cooking, **EXTEND** will appear. If you wish to extend cooking time, enter the desired time by pressing **TIME** and press **START**  /+1min.  If not, press **STOP/CLEAR**. After the oven has cooled, remove and empty the water tank, wipe oven cavity. Empty the drip tray. 

NOTES:

1. "Err" will be displayed at step 2 if the longer time than the maximum time for each Steam cooking mode is entered. To clear, press **STOP/CLEAR** and re-programme.
2. To extend steaming times, see **EXTENDING COOKING TIME AT THE END OF STEAM COOKING** on page EN-17. Before extending the cooking time, make sure the water tank is filled to the MAX mark with room temperature water suitable for drinking (filtered) and is installed.
3. Keep the door closed. If opened during cooking, steam will escape and a longer cooking time will be required.
4. The amount of water in the water tank is sufficient for one cooking operation. Water does not need to be added during cooking.
5. During and after cooking, condensed water may be on the door, oven walls and oven floor. Dry any liquid residue with a soft cloth. After the last use of the day, we recommend to operate the oven with Grill for 3 minutes without food for drying the water off around grill heating element.
6. After cooking, the oven will automatically cool and you will hear the sound of the cooling fan. The fan may continue to operate up to 10 minutes depending on the oven and parts temperature.

WARNINGS:

1. The oven door, outer cabinet, oven cavity, accessories, dishes and especially the grill heating element will become hot. Use thick oven gloves when adding or removing foods to prevent burns.
2. Do not open the oven with your face close to the oven. Steam from the oven may cause burns.

MANUAL COOKING

Grill

The grill heating element at the top of the oven cavity has one power setting only. This mode does not use steam. This mode can be programmed for up to 99 minutes 50 seconds. 1 layer cooking only. Place the food onto the rack on glass tray and select desired position depending on the food size.

* Suppose you want to cook for 10 minutes on Grill.

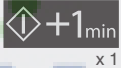
PROCEDURE	
1 Enter the desired cooking time by pressing TIME (10.00).	
2 Press GRILL .	
3 Press START \diamond /+1min.	

WARNING:



The oven door, outer cabinet, oven cavity, accessories, dishes and especially the grill heating element will become hot. Use thick oven gloves when adding or removing foods to prevent burns.

NOTES:

1. Keep the door closed. If opened during cooking, heat will escape and a longer cooking time will be required.
2. After cooking, the oven will automatically cool and you will hear the sound of the cooling fan. The fan may continue to operate up to 10 minutes depending on the oven and parts temperature.





Combi

Combi combines microwave power with grill. Combi has 2 options; Combi High and Combi Low. This mode does not use steam. This mode can be programmed for up to 99 minutes 50 seconds. 1 layer cooking only.

Cooking mode	Cooking method (Initial setting)	Microwave Power Range	Display
Combi High 	Grill 100% Microwave 30%	10 - 70%	H30P
Combi Low 	Grill 50% Microwave 30%	10 - 70%	L30P

The display (H30P or L30P) is initial settings. "30P" means the microwave power level, and it will change depending on your setting.

* Suppose you want to cook for 20 minutes on Combi High using 50% microwave power.

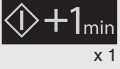
PROCEDURE	
1 Enter the desired cooking time by pressing TIME (20.00).	
2 Select the cooking mode by pressing COMBI HIGH once.	
3 Change the microwave power level by pressing the selected Combi mode key (COMBI HIGH) or MICROWAVE POWER LEVEL 3 times.	 or 
4 Press START \diamond /+1min.	

WARNING:

The oven door, outer cabinet, oven cavity, accessories, dishes and especially the grill heating element will become hot. Use thick oven gloves when adding or removing foods to prevent burns.

NOTES:

1. Keep the door closed. If opened during cooking, heat will escape and a longer cooking time will be required.
2. After cooking, the oven will automatically cool and you will hear the sound of the cooling fan. The fan may continue to operate up to 10 minutes depending on the oven and parts temperature.
3. When you cook large quantity of food, the water contained in food may be drained into the drip tray. Remove and empty the drip tray after cooking.

ENGLISH

MANUAL COOKING

Microwave

Microwave is fast and convenient for cooking, reheating and defrosting. First enter the cooking time then the power level. This mode does not use steam. This mode can be programmed for up to 99 minutes 50 seconds. There are 6 different power levels.

Display	Power level	Examples
100P	100% (900 W)	Raw meat, vegetables, rice or pasta
70P	70% (630 W)	Roast joints, meat loaf and plated meals
50P	50% (450 W)	Delicate foods such as eggs or seafood.
30P	30% (270 W)	Defrost, softening butter or simmering dumplings and cooking egg custard.
10P	10% (90 W)	Keep food warm or gentle defrosting, such as cream gateaux or pastry.
0P	0% (0 W)	

This variable cooking control allows you to select the rate of microwave cooking. If a power level is not selected, then 100% is automatically used. 1 layer cooking only.

* Suppose you want to cook for 5 minutes on 100%.



PROCEDURE

- 1 Enter the desired cooking time by pressing **TIME** (5.00). 
- 2 Press **START**  /+1min. 

To change the microwave power level, press **MICROWAVE POWER LEVEL** until the desired power level is displayed.

* Suppose you want to defrost for 5 minutes on 30%.

PROCEDURE

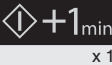
- 1 Enter the desired cooking time by pressing **TIME** (5.00). 
- 2 Change the power level by pressing **MICROWAVE POWER LEVEL** until the desired microwave power level is displayed (30P). 
- 3 Press **START**  /+1min. 

NOTES:

1. After cooking, the oven will automatically cool and you will hear the sound of the cooling fan. The fan may continue to operate up to 10 minutes depending on the oven and parts temperature.
2. Do not use the steam tray and metal rack.
3. When you cook large quantity of food, the water contained in food may be drained into the drip tray. Remove and empty the drip tray after cooking.

HINT:

For cooking cake or meatloaf, place the container on the glass tray in lower position (position 2) .

OTHER CONVENIENT FEATURES

More or Less Time Adjustment (LESS (▼) / MORE (▲) keys)

a) To use with automatic cooking:

You can adjust cooking results as you like.

Should you discover that you like any automatic settings slightly **more** done, press **MORE (▲)** after entering weight and before pressing **START** \diamond /+1min.

Should you discover that you like any automatic settings slightly **less** done, press **LESS (▼)** after entering weight and before pressing **START** \diamond /+1min.

b) To use with manual cooking:

During the manual cooking process, the cooking time can be decreased or increased in 1 minute steps each time the **LESS (▼)** and **MORE (▲)** are pressed.

NOTE: You can not use this function for Steam cooking.

Extending Cooking Time at the End of Steam Cooking

This function is for **Steam Menus** (except Steam Defrost), **Steam High** and **Steam Low** only. Cooking results may vary depending on room temperature, initial food temperature and other factors. You can adjust cooking results by adding more cooking time at the end. When cooking is finished, the display will show "EXTEND". It is only possible to add extra time during the 5 minutes when "EXTEND" is in the display. The time can be extended up to 10 minutes. Enter the desired time by pressing **TIME** and then press **START** \diamond /+1min. The same cooking mode will be continued. Carefully check the cooking process.

NOTES:







1. Before extending Steam mode, make sure the water tank is filled to the MAX mark with room temperature water suitable for drinking (filtered) and is installed. If "Err, WATER (flashing)" is displayed during cooking, fill the water tank to the MAX mark. Position and push firmly into place, then press **STOP/CLEAR** to clear the error message. To continue the cooking, cook manually. Check for doneness from time to time.
2. Extend mode is cancelled when **STOP/CLEAR** is pressed.
3. The Extending Cooking Time function can be repeated until the food is cooked as you desire.
4. While the display shows "EXTEND", Energy Save Mode will be cancelled temporary.

Multiple Sequence Cooking

This function allows you to cook using up to 3 manual cooking programmes; combinations of Microwave, Grill and Combi.

- * Suppose you want to cook in Sequence Cooking for:
- 5 minutes on 70 % microwave power (Stage 1)
 - 3 minutes on Grill (Stage 2)
 - 3 minutes on Combi High using 50% microwave power (Stage 3)

PROCEDURE

- 1 For 1st stage, enter the desired cooking time by pressing **TIME** (5.00) and press **MICROWAVE POWER LEVEL** until the desired microwave power level is displayed (70P).
 
- 2 For 2nd stage, enter the desired cooking time by pressing **TIME** (3.00) and press **GRILL**.
 
- 3 For 3rd stage, enter the desired cooking time by pressing **TIME** (3.00) and press **COMBI HIGH** until the desired microwave power level is displayed (H50P).
 
- 4 Press **START** \diamond /+1min.

NOTE:

After cooking, the oven will automatically cool and you will hear the sound of the cooling fan. The fan may continue to operate up to 10 minutes depending on the oven and parts temperature.

WARNING:

The oven door, outer cabinet, oven cavity, accessories, dishes and especially the grill heating element will become hot. Use thick oven gloves when adding or removing foods to prevent burns.

ENGLISH

OTHER CONVENIENT FEATURES

Kitchen Timer

Use the Kitchen Timer as a minute timer or to monitor the standing time for cooked/defrosted food.

- Suppose you want to set the kitchen timer for 5 minutes.

PROCEDURE

1 Open and close the door to activate Kitchen Timer function.

2 Enter the desired time by pressing **TIME** (5.00).

1
MIN
x 5

3 Press **INFO/KITCHEN TIMER** once.

i / **↻**
x 1

Minute Plus Function

START \diamond /+1min allows you to operate the two following functions:

a) Direct start

You can directly start cooking on 100% microwave power for 1 minute by pressing **START** \diamond /+1min.

NOTE:

To avoid the misuse by children **START** \diamond /+1min can be used only within 3 minutes after preceding operation, i.e., closing the door, pressing the **STOP/CLEAR** key or cooking completion.

b) Extend the manual cooking time

You can extend the manual cooking time for multiples of 1 minute if **START** \diamond /+1min is pressed while the oven is in operation.

NOTE:

You can not use this function for Steam cooking. The cooking time can be extended up to 99 minutes.

Info

Info provides 5 features.

In F1: Drain
In F2: Descale
In F3: Water Hardness
In F4: Demo Mode
In F5: Child Lock

These features can be selected by pressing **INFO/KITCHEN TIMER** until the desired function is displayed and pressing **START** \diamond /+1min.

DRAIN

The remaining water inside the steam generator can be evaporated by using the DRAIN function. See page EN-9.

DESCALE

See page EN-9.

WATER HARDNESS

Your oven is set at the factory to water hardness setting 3 (Very hard). You can set the oven for the water hardness level.

You can use a test strip available at some drug stores, to check the water hardness level.

In some areas, it is possible to ask the water supply company for the water hardness.

When you use test strips, follow the instructions of them.

Hardness level	Hardness range	Setting
1	<120 ppm <120 mg/l <6.7 °dH	Soft
2	120 - 250 ppm 120 - 250 mg/l 6.7 - 14.0 °dH	Hard
3	>250 ppm >250 mg/l >14.0 °dH	Very hard

PROCEDURE

1 Press **INFO/KITCHEN TIMER** 3 times (In F3).

2 Press **WEIGHT** until the desired hardness level is displayed and press **START** \diamond /+1min. The water hardness setting will be held in the memory even if the oven power is off.



OTHER CONVENIENT FEATURES

Demonstration Mode

This feature is mainly for use by retail outlets, and also allows you to practice the key operation.

To demonstrate, press **INFO/KITCHEN TIMER** 4 times (In F4). And then press **START** \diamond /+1min. "dISP" will appear in the display.

Cooking operations can now be demonstrated with no power in the oven. The display will count down to zero at ten times the speed faster than normal.

To cancel, press **INFO/KITCHEN TIMER** 4 times (In F4). And then press **START** \diamond /+1min. The display will show "dISP OFF". Or unplug the oven from the electrical outlet and re-plug to cancel Demo Mode.

NOTES:

1. "dISP" will change to ". 0" when pressing **STOP/CLEAR**.
2. If you set Demo Mode, Energy Save Mode will be cancelled.

Child Lock

Child Lock prevents unwanted oven operation such as by small children. The oven can be set so that the control panel is deactivated and locked.

To set the Child Lock, press **INFO/KITCHEN TIMER** 5 times (In F5). And then press **START** \diamond /+1min. "SAFE" will appear in the display. The control panel is now locked, each time a key is pressed, the display will show "SAFE".

To unlock the control panel, press **INFO/KITCHEN TIMER** 5 times and **START** \diamond /+1min quickly. The display will show "SAFE OFF" and the oven is ready to use.

NOTES:

1. If you set Child Lock, Energy Save Mode will be cancelled.
2. When the oven power is off, the setting returns to OFF.

ENGLISH





CLEANING AND CARE

Key Point for Cleaning - Immediately and frequently!

The food splashes and oily meat juice, remaining on the oven interior walls will get stuck and hard to remove if it is not cleaned immediately and after each use. The usage of the steam function will assist in this cleaning process. They will be also perishable by the influence of steam.

CAUTION: DO NOT USE COMMERCIAL OVEN CLEANERS, STEAM CLEANERS, ABRASIVE, HARSH CLEANERS, ANY THAT CONTAIN SODIUM HYDROXIDE OR SCOURING PADS ON ANY PART OF YOUR MICROWAVE OVEN.

Before cleaning, make sure the oven cavity, door, oven cabinet, accessories and especially the grill heating element are completely cool.

CLEAN THE OVEN AT REGULAR INTERVALS AND REMOVE ANY FOOD DEPOSITS - Keep the oven clean, or the oven could lead to a deterioration of the surface. This could adversely affect the life of the appliance and possibly result in a hazardous situation.

Oven exterior

The outside of your oven can be cleaned easily with mild soap and water. Make sure the soap is wiped off with a moist cloth, and dry the exterior with a soft towel.

Oven controls

Open the door before cleaning to de-activate the oven controls. Care should be taken when cleaning the oven control. Using a cloth dampened with water only, gently wipe the panel until it becomes clean. Avoid using excessive amounts of water. Do not use any sort of chemical or abrasive cleaner.

Door

To remove all trace of dirt, regularly clean both sides of the door, the door seals and adjacent parts with a soft, damp cloth. Do not use harsh abrasive cleaners or sharp metal scrapers to clean the oven door glass since they can scratch the surface, which may result in shattering of the glass.

Door Seals

Always keep the door seals clean to prevent any damage. If water condenses inside the door seals, wipe dry with a soft cloth. Polish with another soft cloth. Do not use a chemical or abrasive cleaner on these surfaces. Care should be taken not to rub, damage, pull or move the seals. Before cooking, always check that door seals is lying smooth and flat. If not, steam will leak from the door. Do not use the oven if it has a damaged door seals. Consult your dealer or an authorised SHARP service agent.

Oven interior

IMPORTANT INFORMATION:

- After every use: Wipe the oven walls with a soft cloth and warm water (or mild soapy water) while the oven is still warm. Using the oven without cleaning may lead spatters to get stuck.
- Do not use caustic cleaners (acidic/alkaline), spray type cleaners, abrasive or harsh cleaners or scouring pads as it may damage the surface of oven walls.

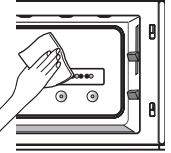

For removal of OIL AND FOOD SPLASHES on oven walls:

1. Fill the water tank with room temperature water suitable for drinking (filtered) through the lid to the MAX mark.
2. Operate the oven with Steam High for 10 minutes without food. See page EN-14.
3. After the steaming, wipe the dirt in the oven interior with a dry soft cloth while the oven is still warm. Be aware that the grill heating element and steam outlets may be still hot, so take care when wiping the ceiling and cavity back plate. (The grill heating element will turn on for a very short time before at the end of the operation.) And then, we recommend to operate the oven with Grill for 3 minutes without food and accessories for drying the water off around grill heating element.

Steam Tray / Glass Tray / Rack

Wash steam tray, glass tray and rack after cooking with a mild soap or detergent solution, rinsing and polishing dry. Do not use harsh cleaners, sharp metal scrapers or stiff brushes to prevent damage to the easy clean surface. All the accessories can be washed in the dishwasher. Do not leave the steam tray and rack wet.

Water Tank and Water Tank Lid

After cooking, wash in a mild soap or detergent solution with a soft damp cloth or sponge, rinse and polish dry. Do not wash in the dishwasher. Do not use harsh cleaners, sharp metal scrapers or stiff brushes on the water tank and water tank lid.

Drip Tray

Empty drip tray after cooking, wash in a mild soap or detergent solution with a soft damp cloth or sponge, rinse, polish dry and replace below the oven front. Do not wash in the dishwasher.

Descaling within the Oven's Steam Parts

During steam production, scale may form in the steam generator. To remove scale, carry out descale function when "DESCALE" flashes on and off in the display. See page EN-9 for complete instructions.



TROUBLESHOOTING CHART

If EE is displayed or you think the oven is not working properly, check the chart below before consulting an authorised SHARP Service Agent. This will help to prevent unnecessary service calls.

WARNING:

Never adjust, repair or modify the oven by yourself. It is hazardous for anyone other than a qualified service technician trained by SHARP to carry out any service or repair operation. This is important as it may involve the removal of covers that provide protection against electrical parts.

- Repairs and Modifications: Do not attempt to operate the oven if it is not working properly.
- Outer cabinet: Never remove the outer cabinet to avoid the possibility of electric shock or burns.

Troubleshooting Chart



TECHNICAL ERROR MESSAGE / INFORMATION MESSAGE

MESSAGE ON DISPLAY		ACTION
TECHNICAL ERROR MESSAGE	EE	Due to technical error, call your dealer or an authorised SHARP Service Agent.
INFORMATION MESSAGE	Err (when pressing START \diamond /+1min)	The water in the internal steam system is frozen. Operate the oven with Grill without food for 10 minutes. See page EN-15.
	Err (when pressing STEAM HIGH or STEAM LOW)	The time you set is over the maximum time for Steam High or Steam Low. Press STOP/CLEAR and re-programme.
	Err, HOT (flashing)	The oven is too hot to use for Steam Defrost, Auto Defrost Menus or Steam Low. Remove food from oven and allow to cool until the message clears.
	Err, WATER (flashing)	Remove water tank and fill with water to the MAX mark. Replace and push firmly into place, then press STOP/CLEAR to clear the error message. Make sure that the water tank is filled to the MAX mark with room temperature water suitable for drinking (filtered). To continue the cooking, cook manually. Check for doneness from time to time. NOTES: 1. Ensure you do not use any other liquids like distilled water, R.O water, mineral water and etc. 2. When this error message appears again and again even if you fill the water tank with water, the internal steam system may be out of order. Call your dealer or an authorised SHARP Service Agent. You can use the oven for the cooking modes which do not use steam.
	DESCALE (flashing)	Follow step-by-step instructions for descaling. See page EN-9.
	HOT (flashing)	The oven cabinet and oven cavity are very hot. Pay extra attention not to burn yourself.



TROUBLESHOOTING CHART

The following situations are normal and are not signs that the oven is malfunctioning.

QUESTION / SITUATION		ANSWER
Control panel / power supply	The display is black / blank.	<ul style="list-style-type: none"> * Open the door and close. * Check the power plug is properly connected to a suitable wall outlet. * Check the wall socket and fuse are functioning properly. * Disconnect the power cord, wait for a minute. Then reconnect, open and close the door.
	The display is fine but START  /+1min will not function when pressed.	<ul style="list-style-type: none"> * Open the door and close. Is the oven light off? Press START /+1min again. * If the message "Err, HOT (flashing)" is displayed, wait until the message has disappeared.
	Electrical power supply is interrupted during cooking.	The programmed cooking time and mode will be cancelled. Continue to cook with manual mode.
Energy save mode	The display does not change to blank.	<p>In the following cases, Energy Save Mode will be cancelled temporary:</p> <ul style="list-style-type: none"> - When the door is opening. - Pause of the automatic cooking. - When the cooking fan is working after cooking. - Demonstration mode - Child lock - Extend mode - Drain mode - Descaling mode - Kitchen timer mode - When the display shows "Err, WATER (flashing)".
Water	Leakage water from the bottom front of the oven.	<ul style="list-style-type: none"> * Check the drip tray is installed correctly. Remove and replace the drip tray correctly. See page EN-7. * Did you empty the drip tray before the cooking? You must empty the drip tray and replace it before Steam Cooking will start. See page EN-7.



TROUBLESHOOTING CHART

The following situations are normal and are not signs that the oven is malfunctioning.

QUESTION / SITUATION		ANSWER
Steam	Water is found inside the oven when the door is opened.	Steam has condensed inside the oven. Wipe dry with a soft cloth or a sponge after cooling.
	Steam comes out from the bottom of the oven.	The air ventilation openings are at the oven bottom (left side). It is normal for used steam to come from the air ventilation openings. Be aware that hot steam comes out during steam cooking, and keep children away from the oven.
	Condensed water can be seen in the oven cavity.	This operation is normal. Steam has condensed on the oven floor. Wipe dry with a soft cloth or a sponge after cooling.
	Steam comes from the door during cooking.	Check the door sealings to make sure it is lying smoothly and flat.
Noise / Sound	Noise during microwave cooking.	When microwaving, you may hear the magnetron cycling on and off depending on the power level.
	Noise after cooking.	The cooling fan will operate until the oven is cool. The fan may continue to operate up to 10 minutes depending on the oven and parts temperatures.
	Noise when cooking with high temperature.	High temperatures may cause expansion of the oven's components. This is normal.
Smoke / Aroma	When using the oven for the first time, it may smoke or smell.	See page EN-10 for step-by-step instructions for cleaning the oven before the first use.
Cooking result	The menu using the water does not have a good result.	<ul style="list-style-type: none"> * Did you fill the water tank with water to the MAX mark before cooking? * Did you take the water tank off from the oven during the cooking? Do not remove the water tank during the cooking except for the case instructed in the cookbook or the operation manual. * Did you use the glass tray? See the important instructions on page EN-7-8.
Food spatters	It is difficult to remove food spatters stuck on the oven walls.	See "For removal of OIL AND FOOD SPLASHES on oven walls:" on page EN-20. It is important to clean the oven interior after every use.
Others	Time appearing in the display is counting down very rapidly.	Check Demonstration Mode on page EN-19 and cancel.
	Hot air comes out from the bottom of the oven.	The air ventilation openings are at the oven bottom (left side). This is normal. Be aware that hot air comes out during combi cooking, and keep children away from the oven.

ENGLISH



SERVICE CALL CHECK

Please check the following before calling for service.

1. Power supply

Check the power plug is properly connected to a suitable wall outlet.

Check the line fuse/circuit breaker is functioning properly.

2. When the door is opened, does the oven lamp light? Yes _____ No _____

3. Place a cup of water (approx. 150 ml) in the oven and close the door securely.

Programme the oven for one minute on 100% power and start the oven.

Does the oven lamp come on? Yes _____ No _____

Does the ventilation work? (You will hear the fan sound.) Yes _____ No _____

Does the Microwave indicator appear in the display? Yes _____ No _____

After 1 minute does the signal sound? Yes _____ No _____

Is the cup with water warm after the above operation? Yes _____ No _____

4. Take the cup of water out of the oven and close the door.

Programme the grill for 5 minutes and start the oven.

Does the Grill indicator appear in the display? Yes _____ No _____

After 5 minutes is the inside of the oven hot? Yes _____ No _____

5. Fill the water tank with water and replace.

Operate the oven for 3 minutes on Steam High.

After the oven stops, is the inside of the oven filled with steam? Yes _____ No _____

If "NO" is the answer to any of the above questions, call your dealer or an authorised SHARP Service Agent and report the results of your check.

IMPORTANT: If the display shows nothing even if the power supply plug is properly connected, the energy save mode may be in operation. Open and close the oven door to operate the oven. See EN-10.

NOTES:

1. If time in the display is counting down very rapidly, check Demonstration Mode. (Please see page EN-19 for detail.)

2. If you cook the food over the standard time with only the same cooking mode, the power of the oven will lower automatically to avoid overheating. (The microwave power level will be reduced or the grill heating element will begin to turn on and off, though it is hardly visible).

Cooking Mode	Standard time
Microwave 100%	20 minutes
Grill	10 minutes
Combi High	Grill - 10 minutes

800-570-3355

SPECIFICATIONS

AC Line Voltage	: 230 V, 50 Hz, single phase
Distribution line fuse/circuit breaker	: Minimum 16 A
AC Power required:	Microwave : 1.51 kW Grill : 1.1 kW Micro/Grill : 2.53 kW Steam : 0.91 kW Off Mode (Energy Save Mode) : less than 0.5 W
Output Power:	Microwave : 900 W (IEC 60705) Grill : 1.05 kW Steam : 0.86 kW
Microwave Frequency	: 2450 MHz (Group 2/Class B)*
Outside Dimensions	: 520 mm(W) x 331 mm(H) x 500 mm(D)**
Cavity Dimensions	: 343 mm(W) x 210 mm(H) x 381 mm(D)***
Oven Capacity	: 27 litres***
Weight	: approx. 18.1 kg
Oven lamp	: 25 W/240 V

- * This Product fulfils the requirement of the European standard EN55011. In conformity with this standard, this product is classified as group 2 class B equipment. Group 2 means that the equipment intentionally generates radio-frequency energy in the form of electromagnetic radiation for the heat treatment of food. Class B equipment means that the equipment is suitable to be used in domestic establishments.
- ** The depth includes the door opening handle.
- *** Internal capacity is calculated by measuring maximum width, depth and height. Actual capacity for holding food is less.

As part of a policy of continuous improvement, we reserve the right to alter design and specifications without notice.

ENGLISH



COOKING GUIDES

Points To Remember

- Please make reading the Operation Manual your very first step in working with your new oven. This important booklet explains exactly how the oven works and what you need to know to operate it successfully.
- Use the information in the charts and recipes to help adapt your own favorite recipes or convenience foods for preparation in the oven.
- The stated cooking times in the charts and recipes are guidelines and are based on standard conditions. Cooking results will vary according to the conditions of food, utensils and the oven. Please check the cooking result and if necessary, adjust cooking times accordingly.
- Prepare the food and use accessories as instructed.
- When placing food in the oven, turning, stirring or adding something to the food, please ensure the door does not remain open long so as to avoid loss of heat.
- Please refer to Food and Utensil Position Chart on page EN-13 before setting food in the oven.
- Always distribute the ingredients evenly inside a piece of ovenware or steam tray to achieve even cooking results.
- There is no need to fill the water tank for Microwave, Grill, Combi High or Combi Low cooking.
- If you would like to adapt your favorite recipes for the microwave, you should take note of the following: Shorten cooking times by a third to a half. Follow the example of the recipes in this cookery book.

Cooking Techniques

- Determining Cooking Time with a Food Thermometer -

Every drink and every food has a specific internal temperature at the end of the cooking process, at which the cooking process can be ended and the result is good. You can determine the internal temperature with a food thermometer. The most important temperatures are given in the temperature table.

TABLES FOR SETTING THE COOKING TIME WITH THE FOOD THERMOMETER

Drinks/food	Internal temperature at the of minutes	Internal temperature up to 10 to 15 of standing time
Heating drinks (coffee, water, tea, etc.)	65-75°C	
Heating milk	60-65°C	
Heating soups	75-80°C	
Heating stews	75-80°C	
Poultry	80-85°C	85-90°C
Lamb		
Rare cooked	70°C	70-75°C
Well cooked	75-80°C	80-85°C
Beef		
Rare roast	50-55°C	55-60°C
Medium cooked	60-65°C	65-70°C
well done	75-80°C	80-85°C
Pork, Veal	80-85°C	80-85°C



COOKING GUIDES

About Utensils and Coverings

The chart below will help you decide what utensils and coverings should be used in each mode.

Cooking Mode Utensils - Coverings	Steam	Grill	Combi	Microwave
Aluminium Foil	YES	YES	YES	YES
			Small flat pieces of aluminum foil placed smoothly on food can be used to shield areas from cooking or defrosting too quickly. Keep foil at least 2 cm from walls of oven.	
Metal, Foil Containers	YES	YES	NO	NO
China, Ceramics,	YES	YES	YES	YES
	Oven-proof porcelain, pottery, glazed earthenware and bone china are usually suitable. Do not use the container if it has a flaw.		In general, porcelain is suitable. Please be sure that your porcelain does not contain any metal or gold or silver plating. Check manufacturer's recommendation for being microwave safe. Do not use the container if it has a flaw.	
Heat-resistant Glassware e.g. Pyrex®	YES	YES	YES	YES
	Care should be taken if using fine glassware as it can break or crack if heated suddenly.			
Plastic/Polystyrene heat-resistant temp. over 140°C	YES	NO	NO	YES
	Care must be taken as some containers warp, melt or discolour at high temperatures.			Use microwave-safe plastic containers for reheating and defrosting. Some microwave-safe plastics are not suitable for cooking foods with high sugar content. Follow manufacturer's directions.
Plastic Wrap heat-resistant temp. over 140°C	YES	NO	NO	YES
Paper Towels, Paper Plates	NO	NO	NO	YES
	Only use for warming or to absorb moisture. Care must be taken, as overheating may cause fire. Do not use recycled paper towels which may contain metal filings.			
Containers made of synthetic material	NO	NO	NO	NO
	They could melt at high temperature.			
Baking paper	YES	NO	NO	NO
Roasting Bags	NO	NO	NO	YES
	Follow manufacturer's directions.			
Silver Dishes and Cooking Utensils or Containers that might rust inside the oven.	NO	NO	NO	NO
Rack	NO	YES	YES	NO
	The metal rack supplied have been specially designed for Combi and will not damage the oven.			
Steam trays	YES	NO	NO	NO
Glass tray	YES	YES	YES	YES
	To prevent the glass tray from breaking: <ul style="list-style-type: none"> • Before cleaning the glass tray with water, leave the glass tray to cool. • Do not place anything hot on a cold glass tray. • Do not place anything cold on a hot glass tray. 			

ENGLISH

Your Appliance Authority

 800-570-3353



COOKING GUIDES

Utensils should be checked to ensure that they are suitable for use in each cooking mode. When heating food in plastic containers, pay special attention to the melting temperature of the containers. Never heat the plastic containers at over their melting temperature. Keep an eye on the oven due to the possibility of melting and ignition.

ACCESSORIES There are many microwave or heat-resistant accessories available for purchase. Evaluate carefully before you purchase so that they meet your needs. A microwave-safe thermometer will assist you in determining correct doneness and assure you that foods have been cooked to safe temperatures when using microwave-only cooking. Sharp is not responsible for any damage to the oven when accessories are used.

For automatic cooking, use the recommended container in each cooking guide and recipes of the cookbook section.

Steam Cooking Advice

There are certain techniques for cooking with steam. It is essential that these techniques are followed to ensure good results. Many of them are similar to those used in conventional cooking so you may be used to doing them already. Please follow the advice given below for all cooking options which use STEAM MENUS, STEAM HIGH and STEAM LOW.

NOTE:

- Always attend the oven when in use.
- Ensure that the utensils are suitable for STEAM cooking mode. (See About Utensils and Coverings page EN-27)
- Ventilate the room to allow the steam to dissipate.
- After cooking and the oven has cooled, remove and empty the water tank, wipe oven cavity with a soft cloth or sponge. Empty the drip tray.

- Special Advice for STEAM -

Cooking Techniques	
Container	Ensure food is arranged evenly. Food which has little or no space between will take longer to cook, please ensure food is positioned with enough space between items to allow the steam to circulate around it. For the container, a shallow dish is suitable. It is not recommended to use dense dishes, because of the thickness of such dishes, recommended cooking times will have to be extended.
Covering	Covering is not necessary in most cases. If a cover is required, aluminium foil is recommended to keep food becoming wet from the condensed water in the oven cavity. Covered food will take longer to cook.
Door	For accurate cooking times, keep the door closed.
Stir	Sometimes soup or casserole reheated in a casserole without covering looks watery after cooking. Appearance will be better by stirring well.
Stand	Standing time is recommended after cooking so it enables the heat to disperse equally throughout the food. Do not allow to stand for a long time; food may be overcooked or wet by the residual steam.



COOKING GUIDES

- Advice for STEAM -

Food characteristics	
Density	Food density will affect the amount of cooking time needed. Cut the food into thinner parts if possible, and arrange in single layer.
Quantity	The cooking time must be increased as the amount of food cooked in the oven increases.
Size	Small foods and small pieces cook faster than large ones, as heat can penetrate from all sides to the centre. For even cooking make all the pieces the same size.
Shape	Foods which are irregular in shape, such as chicken breasts or drumsticks, may take longer to cook in the thicker parts. Check these parts are cooked thoroughly before serving.
Temperature of food	The initial temperature of food affects the amount of cooking time needed. Chilled foods will take longer to cook than foods at room temperature. The temperature of the container is not the actual temperature of the food or drink.
Seasoning & flavouring	Seasoning or flavouring are best added after cooking. If added as marinades or rubs, their taste may become light when cooking with steam. Add seasoning or flavouring again after cooking if necessary.

NOTE:

- Ensure the food is thoroughly cooked / reheated before serving.
- Cooking time will be affected by the shape, depth, quantity and temperature of food together with the size, shape and material of the container.

Face & Hands: Always use thick oven gloves to remove food or cookware from the oven. Be careful when opening the oven door to allow steam to dissipate. Do not remove the food from the oven with your bare hand.

Check the temperature of food and drink and stir before serving. Take special care when serving to babies, children or the elderly.



COOKING GUIDES

Microwave Cooking Advice

- Special Notes and Warning for MICROWAVE -

	DO	DON'T
Eggs, fruits, nuts, seeds, vegetables, sausages and oysters	<ul style="list-style-type: none"> * Puncture egg yolks and whites and oysters before cooking to prevent "explosion". * Pierce skins of potatoes, apples, squash, hot dogs, sausages and oysters so that steam escapes. 	<ul style="list-style-type: none"> * Cook eggs in shells. This prevents "explosion", which may damage the oven or injure yourself. * Cook hard/soft boiled eggs. * Overcook oysters. * Dry nuts or seeds in shells.
Popcorn	<ul style="list-style-type: none"> * Use specially bagged popcorn for the microwave oven. * Listen while popping corn for the popping to slow to 1-2 seconds. 	<ul style="list-style-type: none"> * Pop popcorn in regular brown bags or microwave safe glass bowls. * Exceed maximum time on popcorn package.
Baby food	<ul style="list-style-type: none"> * Transfer baby food to small dish and heat carefully, stirring often. Check for suitable temperature to prevent burns. * Remove the screw cap and nipple before warming baby bottles. After warming shake thoroughly. Check for suitable temperature. 	<ul style="list-style-type: none"> * Heat disposable bottles. * Overheat baby bottles. Only heat until warm. * Heat bottles with nipples on. * Heat baby food in original jars.
General	<ul style="list-style-type: none"> * Food with filling should be cut after heating, to release steam and avoid burns. * Use a deep bowl when cooking liquids or cereals to prevent boiling over. * Small portions will be done faster than larger ones. A basic rule is: DOUBLE THE AMOUNT = ALMOST DOUBLE THE TIME, HALF THE AMOUNT = HALF THE TIME 	<ul style="list-style-type: none"> * Heat or cook in closed glass jars or airtight containers. * Deep fat fry. * Heat or dry wood, herbs, wet papers, clothes or flowers.
Liquids (Beverages)	<ul style="list-style-type: none"> * For boiling or cooking liquids see IMPORTANT SAFETY INSTRUCTIONS on page EN-2 to prevent explosion and delayed eruptive boiling. 	<ul style="list-style-type: none"> * Heat for longer than recommended time.
Canned foods	<ul style="list-style-type: none"> * Remove food from can. 	<ul style="list-style-type: none"> * Heat or cook food in cans.
Sausage rolls, Pies, Christmas pudding	<ul style="list-style-type: none"> * Cook for the recommended time. (These foods have high sugar and/or fat contents.) 	<ul style="list-style-type: none"> * Overcook as they may catch fire.
Meats	<ul style="list-style-type: none"> * Use a microwave proof roasting rack or plate to collect drained juices. 	<ul style="list-style-type: none"> * Place meat directly on the ceramic oven floor for cooking.
Utensils	<ul style="list-style-type: none"> * Check the utensils are suitable for MICROWAVE cooking before you use them. 	<ul style="list-style-type: none"> * Use metal utensils for MICROWAVE cooking. Metal reflects microwave energy and may cause an electrical discharge known as arcing.
Aluminium foil	<ul style="list-style-type: none"> * Use to shield food to prevent over cooking. * Watch for sparking. Reduce foil or keep clear of cavity walls. 	<ul style="list-style-type: none"> * Use too much. * Shield food close to cavity walls. Sparking can damage the oven.





COOKING GUIDES

- Advice for MICROWAVE -

Cooking Techniques	
Arrange food carefully	Place the thickest areas toward outside of dish.
Watch cooking time	Cook for the shortest amount of time indicated and add more time as needed. Food severely overcooked can smoke or ignite.
Cover foods before cooking	Check recipe for suggestions: paper towels, microwave plastic wrap or a lid. Covers prevent spattering and help foods to cook evenly. (Helps keep oven clean)
Shield foods	Use small pieces of aluminium foil to cover thin areas of meat or poultry in order to avoid overcooking.
Stir foods	From outside to centre of dish once or twice during cooking, if possible.
Turn foods	Foods such as chicken, hamburgers or steaks should be turned over once during cooking.
Rearrange foods	Like meatballs halfway through cooking both from top to bottom and from the centre of the dish to the outside.
Allow standing time	After cooking ensure adequate standing time. Remove food from oven and stir if possible. Cover during standing time can allow the food to finish cooking completely.
Check for doneness	Look for signs indicating that cooking temperature has been reached. Doneness signs include: <ul style="list-style-type: none"> - Steam emits throughout the food, not just at edge; - Joints of poultry can be torn apart easily; - Pork and poultry show no pinkness; - Fish is opaque and flakes easily with a fork.
Condensation	A normal part of microwave cooking. The humidity and moisture in food will influence the amount of moisture in the oven. Generally, covered foods will not cause as much condensation as uncovered foods. Ensure that the ventilation openings are not blocked.
Microwave safe plastic wrap	For cooking food with high fat content, do not bring the wrap in contact with the food as it may melt.
Microwave safe plastic cookware	Some microwave safe plastic cookware are not suitable for cooking foods with high fat and sugar content.
Cake/Meatloaf	For cooking cake or meatloaf, place the container on the glass tray in lower position (position 2).

- Advice for defrosting -

Defrosting Techniques	
Arrange	Arrange food in a single even layer on the shallow dish. This will ensure that all parts of the food defrosts evenly.
Separate	Foods may be stuck together when removed from the freezer. It is important to separate foods as soon as possible during defrosting. e.g. steaks, chops
Stand	Standing time is necessary to ensure food is thoroughly defrosted. Food must stand, covered, for a length of time to ensure the centre has completely defrosted.

NOTE:

- Remove all packing and wrapping before defrosting.







AUTOMATIC COOKING CHART

Steam Menu Guide

- Make sure that the water tank is filled to the MAX mark with room temperature water suitable for drinking (filtered) and is installed.

Rice/Pasta/Egg

Menu number	Menu name	Weight range (Increasing unit)	Procedure	Food/Tray [*] Position						
St11  X 1	White rice (Long grain) (initial temp 20°C)	0.1 - 0.2 kg (100g)	<table border="1"> <thead> <tr> <th>Rice</th> <th>Water</th> </tr> </thead> <tbody> <tr> <td>100 g</td> <td>150 ml</td> </tr> <tr> <td>200 g</td> <td>300 ml</td> </tr> </tbody> </table> <ul style="list-style-type: none"> Place rice in a flat, round dish (23cm diameter) and cover with water. Place the dish on the steam tray in the glass tray. After cooking, stir well and drain off any remain water. 	Rice	Water	100 g	150 ml	200 g	300 ml	2
Rice	Water									
100 g	150 ml									
200 g	300 ml									
St12  X 2	Pasta (initial temp 20°C) (e.g. Fussili, Farfalle, Rigatoni)	0.1 - 0.2 kg (100g)	<table border="1"> <thead> <tr> <th>Pasta</th> <th>Water</th> </tr> </thead> <tbody> <tr> <td>100 g</td> <td>300 ml</td> </tr> <tr> <td>200 g</td> <td>600 ml</td> </tr> </tbody> </table> <ul style="list-style-type: none"> Place pasta in a flat, round dish (23cm diameter) and cover with water. Place the dish on the steam tray in the glass tray. After cooking, stir well and drain off the water. 	Pasta	Water	100 g	300 ml	200 g	600 ml	2
Pasta	Water									
100 g	300 ml									
200 g	600 ml									
St13  X 3	Crème Caramel (initial temp 20°C)		<ul style="list-style-type: none"> Prepare the crème caramel referring to page EN-35. Place the ramekin dishes into the steam tray in upper position (position 3) whereas the glass tray is insert in lower position (position 2). After cooking allow to cool before serving. 	2 & 3						
St14  X 4	Piquant Flan (initial temp 20°C) Vegetable Flan, Cheese and Leek Flan		<ul style="list-style-type: none"> Prepare the flan referring to page EN-35. Place the ramekin dishes into the steam tray in upper position (position 3) whereas the glass tray is insert in lower position (position 2). 	2 & 3						





* On glass tray there is no food.



AUTOMATIC COOKING CHART



Steam Menu Guide

Vegetable 1 layer



Menu number	Menu name	Weight range (Increasing unit)	Procedure	Food Position
 St21 X 1	Fresh Vegetable 1 (initial temp 20°C) Soft Vegetables: Courgette, Pepper, Broccoli, Mushrooms, Asparagus	0.2 - 0.8 kg (100g)	<ul style="list-style-type: none"> Prepare the vegetables and cut into similar pieces, e.g. strips, florets, cubes or slices except for asparagus and small mushrooms. Distribute the vegetables evenly into the steam tray on the glass tray. 	2
 St22 X 2	Fresh Vegetable 2 (initial temp 20°C) Hard Vegetables: Carrots, Cauliflower, Beans, Brussels Sprouts	0.2 - 0.8 kg (100g)	<ul style="list-style-type: none"> Prepare the vegetables and cut into similar pieces, e.g. strips, florets, cubes or slices. Distribute the vegetables evenly into the steam tray on the glass tray. 	2
 St23 X 3	Frozen Vegetable (initial temp -18°C) Mixed Vegetables, Brussels Sprouts, Broccoli, Peas	0.2 - 0.8 kg (100g)	<ul style="list-style-type: none"> Place frozen vegetables in the steam tray on the glass tray. 	2
 St24 X 4	Boiled Potato (initial temp 20°C)	0.2 - 0.8 kg (100g)	<ul style="list-style-type: none"> Peel the potatoes and cut into similar pieces of approx. 25g. Place the potatoes into the steam tray on the glass tray. After cooking, allow to stand for approx. 2 minutes before serving. 	2
 St25 X 5	Small Jacket Potato (initial temp 20°C)	0.2 - 0.8 kg (100g)	<ul style="list-style-type: none"> Please use potatoes with a similar size of approx. 50g. Place the potatoes into the steam tray on the glass tray. After cooking, allow to stand for approx. 2 minutes before serving. 	2

ENGLISH

Fish/Chicken

Menu number	Menu name	Weight range (Increasing unit)	Procedure	Food Position
 St31 X 1	Fish Fillet (initial temp 5°C)	0.2 - 0.8 kg (100g)	<ul style="list-style-type: none"> If desired, sprinkle the fish with lemon juice and pepper. Place the fish fillets into the steam tray on the glass tray. After cooking serve. When the fish fillet is thick, extend the cooking time if necessary. 	2
 St32 X 2	Chicken Fillet (initial temp 5°C)	0.2 - 0.8 kg (100g)	<ul style="list-style-type: none"> Season the chicken fillets with salt, pepper and paprika or curry powder. Place the chicken fillets into the steam tray on the glass tray. After cooking serve. 	2

Balanced Menu

Menu number	Menu name	Weight range (Increasing unit)	Procedure	Food Position
 St41 X 1	Fish Dishes (initial temp 20°C) Salmon fillets with broccoli florets Creamy fish fillet with a vegetable mix and couscous	1 - 4 serves (1 serve)	<ul style="list-style-type: none"> Prepare the fish dishes referring to page EN-36. For the creamy fish fillet with vegetable mix and couscous, press the MORE key. 	2 & 3
 St42 X 2	Chicken Dishes (initial temp 20°C) Chicken breast with potato wedges and a vegetable medley, Basil Chicken kebabs with sun dried tomato rice	1 - 4 serves (1 serve)	<ul style="list-style-type: none"> Prepare chicken dishes referring to page EN-37. For the basil chicken kebabs with sun-dried tomato rice, press LESS key. 	2 & 3









AUTOMATIC COOKING CHART

Steam Menu Guide

Vegetable 2 layers (Vegetable + Potato)

Menu number	Menu name	Weight range (Increasing unit)	Procedure	Food Position
St51  X 1	Vegetable 1 + Potato (initial temp 20°C) Soft Vegetables: Courgette, Pepper, Broccoli, Mushrooms, Asparagus	0.4 - 1.2 kg* (100g) * Total weight of vegetables and potatoes. Both are equal weight.	<ul style="list-style-type: none"> Peel the potatoes and cut into similar pieces of approx. 25g. Prepare the vegetables and cut into similar pieces, e.g. strips, florets, cubes or slices expect for asparagus and small mushrooms. Place the potatoes in the steam tray on the glass tray. Place the vegetables in the other steam tray. Place the glass tray with the potatoes on the steam tray into the oven and start to cook. When the oven stops and the audible signals sound, place the steam tray with the vegetables into the oven and continue to cook. 	Potato: 2 Vegetable: 3
St52  X 2	Vegetable 2 + Potato (initial temp 20°C) Hard Vegetables: Carrots, Cauliflower, Beans, Brussels Sprouts	0.4 - 1.2 kg* (100g) * Total weight of vegetables and potatoes. Both are equal weight.	<ul style="list-style-type: none"> Peel the potatoes and cut into similar pieces of approx. 25g. Prepare the vegetables and cut into similar pieces, e.g. strips, florets, cubes or slices. Place the potatoes in the steam tray on the glass tray. Distribute the vegetables evenly in the other steam tray. Place the trays into the oven and start to cook. 	Potato: 2 Vegetable: 3

Steam Defrost

Menu number	Menu name	Weight range (Increasing unit)	Procedure	Food Position
Sd1  X 1	Fish Steak (initial temp -18°C)	0.2 - 0.6 kg (100g)	<ul style="list-style-type: none"> Place the fish steak in a shallow dish. When the oven stops and the audible signals sound, turn over. After defrosting remove any water and icy glaze and allow to stand for 5-10 minutes until thoroughly defrosted. 	1
Sd2  X 2	Fish Fillet (initial temp -18°C)	0.2 - 0.6 kg (100g)	<ul style="list-style-type: none"> Place the fish steak in a shallow dish. When the oven stops and the audible signals sound, turn over. After defrosting remove any water and icy glaze and allow to stand for 5-10 minutes until thoroughly defrosted. 	1
Sd3  X 3	Frozen Sushi (initial temp -18°C)	1 package only (260g)	<ul style="list-style-type: none"> Transfer sushi to a shallow dish. After defrosting, stand for 10 minutes. 	1



AUTOMATIC COOKING CHART

RECIPES FOR RICE/PASTA/EGG

Crème Caramel (St13)

[Utensils]

4 Ramekin dishes

Steam tray

Glass tray

[Ingredients]

200 ml Milk

1/2 Vanilla pod

100 ml Pouring cream

2 Eggs

1 Egg yolk

30 g Sugar

Ingredients for the caramel

100 g Sugar

4 tbsp Cold Water

Serves 4

[Procedure]

1. Warm the milk and vanilla pod for 1 minute on 100% microwave power, then add the cream.
2. Whisk the eggs and egg yolk with the sugar. Remove the vanilla pod from the milk. Pour the milk into the eggs and mix well.
3. For the caramel, dissolve the sugar in the water, stirring continuously. Bring to the boil without stirring until a golden-yellow caramel forms.
4. Coat the base of each ramekin with the caramel. Allow to cool.
5. Fill each ramekin with the milk mixture.
6. Place the ramekins in the steam tray, and place the tray on upper position (position 3) . Place the glass tray without food on lower position (position 2). Cook on STEAM MENU  St13 "Crème Caramel".
7. After cooking, allow to cool before serving.

ENGLISH

Piquant Flan (St14)

Vegetable flan

[Utensils]

8 Ramekin dishes

(diameter approx. 8cm)

Steam tray

Glass tray

[Ingredients]

150g Cauliflower, florets

200g Frozen Peas

200g Carrots, sliced

Butter and fine breadcrumbs for the ramekin dishes



5 Eggs

200g Crème fraîche

Salt, pepper, grated nutmeg

Serves 4

[Procedure]

1. Place the vegetables in the steam tray on the glass tray in lower position (position 2) and pre-cook the vegetables for 20 minutes with STEAM HIGH .
2. Remove from the oven and allow to cool.
3. Grease the ramekin dishes with the butter and sprinkle with the breadcrumbs. Add some vegetables to each dish. Whisk the eggs and crème fraîche with the seasoning, and pour over the vegetables.
4. Place the ramekin dishes in the steam tray and place the tray on upper position (position 3). Place the glass tray without food on lower position (position 2). Cook on STEAM MENU  St14 "Piquant Flan".

Cheese and leek flan

[Utensils]

8 Ramekin dishes

(diameter approx. 8cm)

Steam tray

Glass tray

[Ingredients]

4 Eggs

125 ml Milk

125ml Pouring cream

50g Grated Emmental cheese

300g Leeks, cut into thin strips

Salt, pepper-grated nutmeg

Butter and fine breadcrumbs for the ramekin dishes

Serves 4

[Procedure]

1. Whisk together the eggs, milk, cream and cheese, mix in the leeks, and season with salt, pepper and nutmeg.
2. Grease the ramekin dishes with the butter and sprinkle with the breadcrumbs. Spoon the cheese and leek mixture into the ramekin dishes.
3. Place the ramekin dishes in the steam tray and place the tray on upper position (position 3). Place the glass tray without food on lower position (position 2). Cook on STEAM MENU  St14 "Piquant Flan".



AUTOMATIC COOKING CHART

RECIPES FOR BALANCED MENUS (St-41 and St-42) OF STEAM MENUS

Salmon fillets with broccoli florets (St-41)

[Utensils] 2 Steam trays, glass tray

Ingredients	1 portion	2 portions	3 portions	4 portions
Deep-frozen salmon fillets	125 g (1 piece)	250 g (2 pieces)	375 g (3 pieces)	500 g (4 pieces)
Lemon juice, pepper				
Broccoli florets	100 g	200g	300 g	400g

[Preparation]

1. Sprinkle the deep-frozen fish fillets with lemon juice and pepper and place into the steam tray on the glass tray. Insert the trays in lower position (position 2).
2. Place the broccoli florets into second steam tray. Insert the steam tray in upper position (position 3) and cook together on STEAM MENUS  St-41.



Creamy fish fillet with a vegetable mix and couscous (St-41 and pressing MORE key)

[Utensils] 2 Steam trays

Pyrex quiche flan dish (27cm diameter), flat round Pyrex dish (22cm diameter) for 4 portions
(Please adjust the containers for the other portions)

Ingredients	1 portion	2 portions	3 portions	4 portions
Fish fillets (rose fish or cod fish), cubed	125 g (1 piece)	250 g (2 pieces)	375 g (3 pieces)	500 g (4 pieces)
Lemon juice, salt, pepper				
Leeks, sliced	50 g	100 g	150 g	200 g
Cherry tomatoes	50 g	100 g	150 g	200 g
Crème fraîche	25 g	50 g	75 g	100 g
Couscous	62.5 g	125 g	187.5 g	250 g
Cold vegetable stock	125 ml	250 ml	375 ml	500 ml

[Preparation]

1. Put the fish into the quiche dish. Sprinkle the fish with lemon juice and season with salt and pepper. Add the vegetables and mix well.
2. Place the quiche dish into the steam tray on the glass tray and insert in lower position (position 2).
3. Put the couscous into the flat round Pyrex dish. Pour the vegetable stock over the couscous. Place the dish in the second steam tray in upper position (position 3) and cook together on STEAM MENUS  St-41 by pressing the MORE  key.
4. Stir the couscous immediately after cooking and add the crème fraîche to the fish with vegetable mix. Season to taste with salt and fresh ground pepper.



AUTOMATIC COOKING CHART

Chicken breast with potato wedges and a vegetable medley (St-42)

[Utensils] 2 Steam trays, glass tray

Ingredients	1 portion	2 portions	3 portions	4 portions
Chicken breast fillets	150 g	300 g	450 g	600 g
Salt, pepper, paprika				
Potatoes, peeled cut into wedges	75 g	150 g	225 g	300 g
Mushrooms, cut into half	50 g	100 g	150 g	200 g
Red pepper, sliced	50 g	100 g	150 g	200 g
Broccoli florets	40 g	80 g	120 g	160 g
Fresh parsley, chopped				

[Preparation]

1. Coat the chicken fillets with the seasoning and place the chicken fillets into the steam tray. Place the steam tray on the glass tray in lower position (position 2).
2. Place the potato wedges in single layer on the second steam tray. Mix the other vegetables together and place in the remaining area of the steam tray. Place the steam tray in upper position (position 3) and cook together on STEAM MENU  St-42.
3. After cooking sprinkle the mixed vegetables with chopped parsley.

Basil chicken kebabs with sun-dried tomato rice (St-42 and pressing the LESS key)



[Utensils] Wooden skewers

Flat round Pyrex dish (22cm diameter) for 4 portions (Please adjust the container for the other portions)

2 Steam trays, glass tray





Ingredients	1 portion	2 portions	3 portions	4 portions
Chicken breast, cut into cubes	100 g (4 cubes)	200 g (8 cubes)	300 g (12 cubes)	400 g (16 cubes)
Large fresh basil leaves	4	8	12	16
Olive oil, soy sauce, Tabasco, pepper, paprika				
Yellow pepper, cut into segments	40 g (4 segments)	80 g (8 segments)	120 g (12 segments)	160 g (16 segments)
Button mushrooms	3	6	9	12
10-minute wholegrain rice	50 g	100 g	150 g	200 g
Sun-dried tomatoes, chopped	15 g	30 g	45 g	60 g
Hot water	75 ml	150 ml	225 ml	300 ml

[Preparation]

1. Wrap each chicken cube with a basil leaf and thread the chicken and vegetables alternately onto the wooden skewers.
2. Combine the oil with the spices and brush over the skewers. Marinade in the refrigerator for 1 hour. Place the kebabs into a steam tray on the glass tray in lower position (position 2).
3. Place the wholegrain rice and sun-dried tomatoes into the flat round Pyrex dish.
4. Pour the hot water over the rice and mix well.
5. Place the dish directly into the steam tray and place it in upper position (position 3).
6. Cook together on STEAM MENU  St-42 by pressing the LESS  key.

AUTOMATIC COOKING CHART

Auto Grill Menus Guide

Menu number	Menu name	Weight range (Increasing unit)	Procedure	Food Position
AG1  X 1	Chicken Legs (initial temp 5°C) Ingredients for 1 kg (5 pieces) chicken legs: 2 tbsp oil, 1/2 tsp salt, 1 tsp sweet paprika, pepper	0.2 - 1.0 kg (100g)	<ul style="list-style-type: none"> Mix the ingredients and spread on chicken legs. Pierce the skin of the chicken legs. Put the chicken legs on the rack in the glass tray with the thin ends towards the centre. When the oven stops and the audible signals sound, turn the food over. After cooking, let stand for approx. 3 minutes. 	2
AG2  X 2	Grilled Chicken (initial temp 5°C) Ingredients for 1,2 kg grilled chicken: Salt and Pepper, 1 tsp sweet paprika, 2 tbsp oil	0.9 - 2.0 kg (100g)	<ul style="list-style-type: none"> Mix the ingredients and spread on the chicken. Pierce the skin of the chicken with a fork. Put chicken breast side down on the rack in the glass tray. When the oven stops and the audible signals sound, turn the chicken over. After cooking, leave for approx. 3 minutes in the oven, remove and put on a plate for serving. 	1
AG3  X 3	Fish Gratin (initial temp 5°C) * Indications are the total weight of all ingredients.	0.6 - 1.2* kg (100g)	<ul style="list-style-type: none"> See recipes for Fish Gratin on page EN-38-39. 	2
AG4  X 4	Grilled Skewer (initial temp 5°C) * Indications are the total weight of all ingredients.	0.2 - 0.8* kg (100g)	<ul style="list-style-type: none"> See recipes for Grilled Skewer on page EN-39. 	2

RECIPES FOR AUTO GRILL MENUS

AG3 Fish Gratin

Fish Gratin Italian Style

[Ingredients]

600 g Rose Fish Fillet
 250 g Mozzarella. approx
 250 g Tomatoes
 2 tbsp. Anchovy butter
 Salt and pepper
 1 tbsp Chopped basil
 Lemon juice of 1/2 lemon
 2 tbsp Chopped mixed herbs
 75 g Grated Gouda (45% fat)
 Sauce thickening powder

[Procedure]

1. Wash the Fish and dry. Sprinkle with lemon juice and salt and grease with the anchovy butter.
2. Place in a round gratin dish (25 cm).
3. Sprinkle the gouda over the fish.
4. Wash the tomatoes and remove the stalks. Cut into slices and place on top of the cheese.
5. Season with salt, pepper and the mixed herbs.
6. Drain the mozzarella, cut into slices and place on the tomatoes. Spread over the basil.
7. Place the gratin dish into the glass tray in lower position (position 2). Press the **AUTO GRILL MENUS** key 3 times until AG3 appears in the display and then enter the weight (1,2 kg). Press **START**  **+1min** key.

Hint: After cooking remove the fish from the gratin dish and stir in some sauce thickening powder. Cook again on the oven floor (position 1) for 1-2 minutes on 100P microwave power.



AUTOMATIC COOKING CHART

AG3 Fish Gratin

Creamy fish and vegetable gratin

[Ingredients]

600 g Rose Fish Fillet
250 g Leeks
50 g Onion
100 g Carrot
1 tbsp. Butter
Salt, pepper and nutmeg
2 tbsp. Lemon juice
125 g Crème fraîche
100 g Grated Gouda (45% fat)

[Procedure]

1. Wash the leeks and divide in 2 parts from top to bottom. Cut into thin strips.
2. Peel the onions and carrots and cut into thin strips.
3. Put the vegetables, butter and spices into a casserole dish and mix well. Cook on the oven floor (position 1) for 5-6 minutes on 100P microwave power. Stir once in-between cooking.
4. In the meantime wash the fish fillet, dry and sprinkle with lemon juice and salt.
5. Mix the Crème fraîche under the vegetables and season again.
6. Put half of the vegetables in a round gratin dish (25 cm). Place the fish on top and cover with the remaining vegetables. Spread over the Gouda.
7. Place the gratin dish into the glass tray in lower position (position 2). Press the **AUTO GRILL MENUS** key 3 times until AG3 appears in the display and then enter the weight (1,2 kg). Press **START** \diamond /+1min key.

AG3 Fish Gratin

Fish gratin with broccoli

[Ingredients]

500 g Rose Fish Fillet
2 tbsp. Lemon juice
1 tbsp. Butter
2 tbsp Flour
300 ml Milk
Chopped dill, pepper and salt
250 g Frozen broccoli
100 g Grated Gouda (45% fat)

[Procedure]

1. Wash the fish fillet and dry. Sprinkle with lemon juice and salt.
2. Heat together butter and flour in a casserole dish without cover on the oven floor (position 1) for 1-1¹/₂ mins on 100P microwave power.
3. Add the milk and stir well. Cook again without cover on the oven floor (position 1) for 3-4 minutes on 100P microwave power. After cooking stir and season with dill, salt and pepper.
4. Defrost the broccoli in a casserole dish on the oven floor (position 1) for 4-6 mins on 100P microwave power. Once defrosted, place the broccoli into a round gratin dish (25 cm) and put the fish on top and season.
5. Pour the sauce over and sprinkle over the cheese.
6. Place the gratin dish into the glass tray in lower position (position 2). Press the **AUTO GRILL MENUS** key 3 times until AG3 appears in the display and then enter the weight (1,1 kg). Press **START** \diamond /+1min key.

NOTE:

These indications are for 1,2 kg (1,1 kg). If you want to cook other weight, you have to adjust the ingredients.

AG4 Grilled Skewer

Pork kebabs

[Utensils]

Wooden skewers (about 25cm long)

[Ingredients]

400 g Pork cutlets
100 g Bacon
2 Onions (100 g), quartered
4 Tomatoes (250 g), quartered
1/2 Green peppers (100 g), cut into eight segments
3 tbsps Oil
4 tsps Paprika
Salt
1 tsp Cayenne pepper
1 tsp Worcester sauce

[Method]

1. Cut the pork cutlets and bacon into 2-3 cm large dices.
2. Alternate meat and vegetables and place onto the four wooden sticks.
3. Mix the oil with the seasonings, and brush skewers. Place the skewers on the rack in the glass tray in lower position (position 2). Press the **AUTO GRILL MENUS** key 4 times until AG4 appears in the display and then enter the weight (0,8kg) Press **START** \diamond /+1min. When the oven stops and the audible signals sound, turn the skewers over.
4. After cooking, stand for about 2 minutes.





NOTE:

These indications are for 0.8 kg. If you want to cook other weight, you have to adjust the ingredients.



AUTOMATIC COOKING CHART

Auto Defrost Menus Guide

Menu number	Menu name	Weight range (Increasing unit)	Procedure
dE1  X 1	Steak/Chops (initial temp -18°C)	0.2 - 1.0 kg (100g)	<ul style="list-style-type: none"> Place the food on a plate or flan dish on the centre of the oven floor (position1). When the oven stops and the audible signals sound, turn the food over, rearrange and separate if possible. If necessary shield thin parts and warm spots with aluminium foil. After defrosting, wrap in aluminium foil for 10-20 minutes, until thoroughly defrosted. See NOTES below.
dE2  X 2	Minced meat (initial temp -18°C)	0.2 - 1.0 kg (100g)	<ul style="list-style-type: none"> Place the block of minced meat on a plate or in a flan dish on the centre of the oven floor (position 1). When the oven stops and the audible signals sound, turn the food over. Remove the defrosted parts if possible. After defrosting, cover with aluminium foil and stand for 5-10 minutes until thoroughly defrosted. See NOTES below.
dE3  X 3	Poultry (initial temp -18°C) Only poultry without giblets is recommended for this programme	0.9 - 2.0 kg (100g)	<ul style="list-style-type: none"> Place the poultry, breast side down, on an upturned saucer into a flan dish or on a plate on the centre of the oven floor (position 1). When the oven stops and the audible signals sound, turn over and shield thin parts and warm spots with small pieces of aluminium foil. When the audible signals sound again, turn over again. After defrosting rinse with cold water, cover with aluminium foil and stand for 30-60 minutes until thoroughly defrosted. Finally clean the poultry under running water.
dE4  X 4	Bread (initial temp -18°C) Only sliced bread is recommended for this programme	0.1 - 1.0 kg (100g)	<ul style="list-style-type: none"> Distribute the bread slices on a flat plate on the centre of oven floor (position 1). When the audible signals sound, turn over, rearrange and remove defrosted slices. After defrosting separate all slices and distribute on a large plate. Cover the bread with aluminium foil and let stand for 5-15 minutes until thoroughly defrosted.

Foods not listed in the Guide can be defrosted manually using 30P power level setting.

NOTES:

- Steaks and chops should be frozen in one layer.
- Minced meat should be frozen in a thin shape.
- If shielding is necessary for defrosted portions, use small, flat pieces of aluminium foil.
- The poultry should be processed immediately after defrosting.



TABLES FOR MANUAL COOKING

TABLE: HEATING DRINKS AND FOOD

Food/Drink	Quantity -g/ml-	Setting	Power -Level-	Time -Min-	Method
Drinks, 1 cup	150		100P	approx.1	Do not cover
One-plate meal (Vegetables, Meat and garnishes)	400		100P	4 - 6	Sprinkle sauce with water, cover, stir occasionally
Stew, Soup	200		100P	1 - 2 ¹ / ₂	Cover, stir after heating
Garnishes	200		100P	approx.2	Sprinkle with some water, cover, stir occasionally
Meat, 1 slice ¹	200		100P	2 - 3	Sprinkle with some sauce, cover,
Sausages, 2 pieces	180		100P	approx.1 ¹ / ₂	Prick the skin in several places
Baby food, 1 jar	190		100P	¹ / ₂ - 1	Remove the cover, stir well after heating and check the temperature
Melt margarine or butter ¹	50		100P	¹ / ₂ - 1	Cover
Melt chocolate	100		50P	3 - 4	Stir occasionally
Dissolve 6 sheets of gelatine	10		50P	¹ / ₂ - 1	Soak in water, squeeze well and place in a soup bowl; stir occasionally

¹ from refrigerator temperature.

TABLE: DEFROSTING AND COOKING

Food	Quantity -g-	Setting	Power -Level-	Time -Min-	Adding water -Tbps-	Method	Standing time -Min-
Fish fillet	300		100P	6 - 8	-	Cover	1 - 2
Trout, 1 piece	250		100P	6 - 8	-	Cover	1 - 2
One-plate meal	450		100P	9 - 11	-	Cover dish on plate, stir after half of the time	2
Vegetables	300		100P	7 - 9	5 tbsp	Cover, stir after half of the time	2
Vegetables	450		100P	9 - 11	5 tbsp	Cover, stir after half of the time	2
Herb bread, 2 items	350		10P	6 - 8 *	-	Place on the rack into the glass tray in lower position (position 2), turn after (*).	2

TABLE: COOKING FRESH VEGETABLES

Food	Quantity -g-	Setting	Power -Level-	Time -Min-	Adding water -Tbps-	Method	Standing time -Min-
Vegetables (e.g. cauliflower, leeks, fennel, broccoli, paprika, courgettes)	300		100P	6 - 8	3 - 5	Prepare as usual, cover and stir occasionally	2
	500		100P	9 - 11	5		2

Potatoes require 1-3 minutes longer cooking time.

NOTE:

Place the container with the food always on the oven floor (position 1) for heating, defrosting and cooking, unless otherwise instructed.



TABLES FOR MANUAL COOKING

TABLE: DEFROSTING WITH THE MICROWAVE

Food	Quantity -g-	Setting	Power -Level-	Time -Min-	Method	Standing time -Min-
Sausage	300		30P	4 - 5	Lay beside each other, turn after half of the defrosting time.	5 - 10
Piece of fish	700		30P	9 - 12	Turn after half of the defrosting time	30 - 60
Prawns	300		30P	5 - 7	Turn after half of the defrosting time and take out defrosted sections	5
Bread rolls, 2 items	80		30P	approx.1	Only lightly defrost	-
Bread, loaf	1000		30P	9 - 11	Turn after half of the defrosting time	20
Cake, 1 item	150		30P	1 - 3		5
Complete tart, Ø 24cm			30P	8 - 9	After defrosting, cut the cake into similar sized pieces keeping space between each piece and let stand until evenly defrosted.	30 - 60
Butter	250		30P	2 1/2	Only lightly defrost	15
Fruit such as strawberries, raspberries, cherries, plums	250		30P	2 - 4	Lay them evenly beside each other, turn after half of the defrosting time	5

NOTE:

To defrost chops, steaks, minced meat, chicken legs, poultry and sliced bread, please use the automatic programme for AUTO DEFROST MENUS: dE1 - dE4.

During recommended standing time, wrap or cover food in foil.

Place the container with the food always on the oven floor (position 1) for defrosting.

800-570-3355



TABLES FOR MANUAL COOKING

TABLE: COOKING, GRILLING AND BROWNING

Food	Quantity -g-	Setting	Power -Level-	Time -Min-	Method	Standing time -Min-
Roasts (Pork, Veal, Lamb)	500		100P	5 - 7	Season to taste, place onto the rack in the glass tray and place the tray on the oven floor (position 1). Turn over after *.	5 - 10
			30P	6 - 8*		
			70P	4 - 6		
	1000		30P	6 - 8		
			100P	9 - 12		
			30P	8 - 10*		
			70P	8 - 10		
	1500		30P	7 - 9		
			100P	19 - 22		
			30P	11 - 13*		
		70P	14 - 16			
Roast beef (medium)	1000		70P	10 - 12	Season to taste, place onto the rack in the glass tray and place the tray on the oven floor (position 1). Turn over after *.	10
			30P	9 - 10*		
			70P	7 - 9		
	1500		30P	7 - 9		
			70P	11 - 13		
			30P	8 - 9*		
			70P	11 - 13		
			30P	6 - 8		
Meatloaf	1000		50P	23 - 25	Prepare minced meat mixture (half pork/half beef). Place the food into a flat oval oven proof dish into the glass tray on the lower position (position 2).	10
			50P	9 - 11		
Steaks 2 medium pieces	400			11 - 13*	Place onto the rack in the glass tray, and place the tray on the upper position (position 3). Turn over after *, season after grilling.	2
				10 - 14		
Browning gratin	1000			14 - 18	Sprinkle 100 g cheddar or 100g gouda on top. Place the oven proof dish into the glass tray and place the tray in lower position (position 2).	10
Hawaiian toast	4 pieces		10P	7 - 10	Toast the bread, spread butter on the toast and top each with a slice cooked ham, pineapple and processed cheese. Pierce in the middle and place the Hawaii toast onto the rack in the glass tray in lower position (position 2).	1

NOTES:

- To grill chicken legs or chicken, please use the AUTO GRILL MENUS: AG1 - AG2.
- Select suitable food position depending on the food size, although the recommended position is mentioned for each food in the above table. Smoke will occur during the cooking if the food touches the grill heating element.

ENGLISH



TABLES FOR MANUAL COOKING

TABLE: COOKING WITH STEAM HIGH

Use glass tray and steam tray. Steam in position 2.

Food	Quantity	Starting Temp.	Setting	Cooking method	Cooking time -Min-	Instructions	Food position
Cauliflower, whole	approx. 900g	20°C	 HIGH	STEAM HIGH	approx. 35	Place the cauliflower into the steam tray on the glass tray.	2
Corn on the cob	4 pieces (800g)	20°C	 HIGH	STEAM HIGH	15 - 18	Place the food into the steam tray on the glass tray.	2
White rice (Basmati)	200g	20°C	 HIGH	STEAM HIGH	approx. 25	Use a flat, round dish (22cm diameter) for cooking. Cover the rice with 300ml tap water and place the dish into the steam tray on the glass tray. After cooking, stir well and drain off any remain water.	2
Par-boiled rice	200g	20°C	 HIGH	STEAM HIGH	approx. 30	Use a flat, round dish (22cm diameter) for cooking. Cover the rice with 300ml tap water and place the dish into the steam tray on the glass tray. After cooking, stir well and drain off any remain water.	2
Brown rice (Long grain)	200g	20°C	 HIGH	STEAM HIGH	approx. 35	Use a flat, round dish (22cm diameter) for cooking. Cover the rice with 300ml tap water and place the dish into the steam tray on the glass tray. After cooking, stir well and drain off the water.	2
Trout	1 pieces (250g)	5°C	 HIGH	STEAM HIGH	approx. 16	Place the food into the steam tray on the glass tray.	2
Blanching vegetables	500g	20°C	 HIGH	STEAM HIGH	8 - 10	Place the prepared vegetables (cleaned, washed, chopped, etc.) into the steam tray on the glass tray. Once blanched, plunge the vegetables into ice water.	2
To skin tomatoes	4 pieces (each 80-100g)	20°C	 HIGH	STEAM HIGH	7 - 9	Cut the tomatoes crosswise on top and place them into the steam tray on the glass tray. After cooking place in cold water, then peel off the skin.	2
Cooking apple, slices	500g	20°C	 HIGH	STEAM HIGH	17 - 20	Place the apple slice into the steam tray on the glass tray.	2
Medium-cooked eggs (size M)	4 pieces	5°C	 HIGH	STEAM HIGH	13 - 14	Place the eggs into the steam tray on the glass tray. After cooking plunge them in cold water.	2
Hard-cooked eggs (size M)	4 pieces	5°C	 HIGH	STEAM HIGH	15 - 17	Place the eggs into the steam tray on the glass tray. After cooking plunge them in cold water.	2
Reheat ready meal, dinner plate (meat and one vegetables)	300g	20°C	 HIGH	STEAM HIGH	18 - 20	Pierce the lid of the convenience food several times with a fork and place the meal into the steam tray on the glass tray and reheat the meal.	2

NOTE:

To cook white rice (long grain), pasta, fresh vegetables, fish fillet, chicken fillet and vegetables + potatoes, please use the STEAM MENU.







TABLES FOR MANUAL COOKING

TABLE: COOKING WITH STEAM LOW

This setting uses a low temperature from 70°C – 95°C in 5°C increments to cook delicate items like terrines, flans, fresh seafood, desserts to perfection. This programme is ideal for slow cooking meat after briefly sear the meat in a hot pan on a hob and where a very tender result is wanted. In the below chart you will find some examples. Use the glass tray in position 2 and the steam tray in position 3.

Food	Quantity	Setting	Cooking method	Temperature setting	Cooking time -Min-	Instructions	Standing time -Min-
Entrecôte, medium	2 pieces (each 350g)	 LOW	STEAM LOW	85°C	30 - 35	Briefly sear the meat from each side for 1-2 minutes in a hot pan on a hob and then transfer the meat immediately into the steam tray in position 3 whereas the glass tray is insert in position 2.	-
Duck breast, medium	2 pieces (each 350g)	 LOW	STEAM LOW	85°C	30 - 35	Score with a sharp knife the fat of the duck breast in a crisscross pattern. Rub the duck breast with salt. Then briefly sear the duck breast from each side for 1- 2 minutes in a hot pan on a hob. Transfer the duck breast immediately into the steam tray in position 3 whereas the glass tray is insert in position 2.	5 - 10
Pork médaillons	8 pieces/ 540g (each 70g)	 LOW	STEAM LOW	85°C	30 - 35	Briefly sear the meat from each side for 1-2 minutes in a hot pan on a hob and then transfer the meat immediately into the steam tray in position 3 whereas the glass tray is insert in position 2.	-

ENGLISH

800-570-3355



RECIPES

Using the Recipes

- All recipes in this cookbook are intended for 4 portions, unless stated otherwise.
- Recommendations for suitable cooking utensils and total cooking time are given at the beginning of each recipe. Total cooking time of each recipe is for the ingredients in the recipes. When you cook with another amount, adjust the cooking time. Usually the recipe will result in ready-to-eat amounts of food, unless another amount is specifically noted.
- The eggs used in the recipes weigh around 55g (Medium).
- Butter and margarine are interchangeable.
- When you cook the food with Combi mode, select suitable food position depending on the food size, although the recommended position is mentioned for each recipe. Smoke will occur during the cooking if the food touches the grill heating element.

Abbreviations Used

P = Percentage
W = Watt
tbsp = table spoon
tsp = teaspoon
min = minutes
kg = kilogram
g = gram
l = litre
ml = millilitre
cm = centimetre
approx. = approximately

Soupes and Starters

CREAM OF AVOCADO SOUP

Spain : Sopa de aguacates

Total cooking time: approx. 9 - 11 minutes

Utensils: Bowl with lid (2 litre capacity)

Ingredients

- | | |
|--------|---------------------------|
| 3 | Avocados (600 g of flesh) |
| | A little lemon juice |
| 700 ml | Meat stock |
| 70 ml | Cream |
| | Salt |
| | Pepper |

Soup insert

SOUP THICKENER with EGG

for one litre of soup

Total cooking time: approx. 20 minutes

Utensils: 2 cups (150 ml capacity)

Ingredients

- | | |
|---------|--------|
| 2 | Eggs |
| 125 ml | Milk |
| 1 pinch | Salt |
| 1 pinch | Nutmeg |

Procedure

1. Peel the soft, ripe avocados, remove stone, cut into small pieces and puree with a mixer or a mixing attachment on a hand mixer. Reserve two thin slivers per portion for decoration and sprinkle with lemon juice.
2. Put the meat stock, avocados and the cream in a dish, season with salt and pepper and cover with the lid. Place it on the centre of the oven floor (position 1) and cook. Stir once during cooking.
9 - 11 min. MICRO 100P
3. Mix soup until creamy and decorate with the remaining avocado slivers. Allow to stand for 5 minutes after cooking.

Procedure

1. Grease the cups. Whisk all ingredients together and pour into the cups.
2. Place the cups into the steam tray in upper position (position 3) whereas the glass tray is insert in lower position (position 2) and cook.
20 min. STEAM LOW 90°C
Allow to stand for about 5 minutes without opening the door.
3. Turn the cooked egg out of the cups and cut into cubes. Add to the soup.

RECIPES

BARLEY SOUP

Switzerland : Bündner Gerstensuppe

Total cooking time: approx. 26 - 33 minutes

Utensils: Bowl with lid (2 litre capacity)

Ingredients

- 2 tbsp Butter or margarine (20 g)
- 1 Onion (50 g), finely chopped
- 1-2 Carrots (130 g), sliced
- 15 g Celery, diced
- 1 Leek (130 g), in rings
- 3 White cabbage leaves (100 g) in strips
- 200 g Veal bones
- 50 g Streaky bacon, in strips
- 50 g Barley grains
- 700 ml Meat stock
- Pepper
- 4 Wiener sausages (300 g)

MUSHROOM SOUP

Netherlands : Champignonsoep

Total cooking time: approx. 10 - 13 minutes

Utensils: Bowl with lid (2 litre capacity)

Ingredients

- 200 g Mushrooms, sliced
- 1 Onion (50 g), finely chopped
- 300 ml Meat stock
- 300 ml Cream
- 2½ tbsp Plain flour (25 g)
- 2½ tbsp Butter or margarine (25 g)
- Salt and Pepper
- 150 g Crème fraîche

CAMEMBERT TOAST

Germany : Camemberttoast

Total cooking time: approx. 1½ - 2½ minutes

Utensils: Flat dish

Ingredients

- 4 Slices of bread for toasting (80 g)
- 2 tbsp Butter or margarine (20 g)
- 150 g Camembert
- 4 tsp Cranberry jelly (40 g)
- Cayenne pepper

Procedure

1. Put the butter and diced onion in the dish and cover with the lid. Place it on the centre of the oven floor (position 1) and cook.
approx. 1 - 2 min. MICRO 100P
2. Add the vegetables to the dish. Then add the bones, the strips of bacon and the barley and fill with the meat stock. Season with pepper and cook with the lid on.
1. 9 - 11 min. MICRO 100P
2. 16 - 20 min. MICRO 50P
3. Chop the sausages into small pieces and heat them for 5 minutes in the dish.
4. After cooking, let the soup stand for 5 minutes. Take the bones out of the soup before serving.

Procedure

1. Place the vegetables and meat stock into the dish. Cover the dish, place it on the centre of the oven floor (position 1) and cook.
7 - 9 min. MICRO 100P
2. Blend all ingredients with a mixer. Add the cream.
3. Knead the flour and butter into dough and mix into the mushroom soup until smooth. Season with salt and pepper, cover and continue to cook.
3 - 4 min. MICRO 100P
4. After cooking stir in crème fraîche, if desired.

Procedure

1. Toast the bread and spread with butter.
2. Cut the Camembert into slices and arrange on top of the toast. Put the Cranberry jelly in the middle of the cheese and sprinkle with Cayenne pepper.
3. Place the toast on a plate. Place the plate on the centre of the oven floor (position 1) and heat.
approx. 1½ - 2½ min. MICRO 100P

Tip: You can vary this recipe according to your taste. For example, you can use fresh mushrooms and grated cheese or cooked ham, asparagus and Emmental cheese.

ENGLISH

RECIPES

Meat, Fish and Poultry

FRESH TUNA WITH VEGETABLES

France : Thon frais braisé aux tomates et aux poivrons

Total cooking time: approx. 15 - 17 minutes

Utensils: Shallow oval gratin dish with lid
(approx. 26 cm diameter)

Ingredients

500 g	Fresh tuna, in slices
2 tbsp	Lemon juice
	Salt
1 tsp	Vegetable oil to grease the dish
1/2	Green pepper (125 g), cut into strips
2	Onions (125 g), finely chopped
1	Carrot (50 g), sliced
1-2	Tomatoes (125 g), diced
40 ml	White wine
1	Clove of garlic
	Bouquet garni
	Salt and pepper

MUSHROOM WITH ROSEMARY

Spain : Champinones rellenos al romero

Total cooking time: approx. 13 - 19 minutes

Utensils: Bowl with lid (1 litre capacity)
Shallow round dish
(approx. 22 cm diameter)

Ingredients

8	Large mushrooms (approx. 300 g), whole
2 tbsp	Butter or margarine (20 g)
1	Onion (50 g), finely chopped
50 g	Bacon, finely diced
	Black pepper, ground
	Fresh rosemary, bruised
125 ml	Dry white wine
125 ml	Cream
2 tbsp	Flour (20 g)

COURGETTE AND MACARONI BAKE

Germany : Zucchini-Nudel-Auflauf

Total cooking time: approx. 33 - 38 minutes

Utensils: Bowl with lid (2 litre capacity)
Gratin dish (approx. 26cm diameter)

Ingredients

500 ml	Water
1/2 tsp	Oil
80 g	Macaroni
400 g	Tinned tomatoes, chopped
3	Onions (150 g), finely chopped
	Basil, thyme, salt, pepper
1 tbsp	Oil to grease the dish
450 g	Courgettes, sliced
150 g	Sour cream
2	Eggs
100 g	Grated cheddar cheese

Procedure

1. Wash the tuna, pat dry and sprinkle with lemon juice. Allow the fish to stand for approximately 15 minutes, then pat dry again and add salt.
2. Spread oil on the bottom of the dish and lay the tuna in it. Arrange the vegetables on top of the fish. Add the white wine, the clove of garlic and the bouquet garni and season. Cover the dish, place the dish on the centre of the oven floor (position 1) and cook.
15 - 17 min. MICRO 70P
Allow the fish to stand for approximately 2 minutes after cooking. Remove the bouquet garni and the clove of garlic before serving.

Tip: A bouquet garni is made of: a sprig of parsley, a bunch of herbs and vegetables for making soup, lovage, thyme and a few bay leaves.

Procedure

1. Remove the stalks from the mushrooms and chop the stalks into small pieces.
2. Spread the butter on the bottom of the dish. Add the onions, the diced bacon and the mushroom stalks. Season with pepper and rosemary, cover and cook on the centre of the oven floor (position 1).
3 - 5 min. MICRO 100P
Leave to cool.
3. Heat 100 ml of the wine and cream in the other dish with its lid on. Place the dish on the centre of the oven floor (position 1).
1 - 3 min. MICRO 100P
4. Mix the remaining wine with the flour, stir into the hot liquid and cook with the lid on. Stir once during cooking.
approx. 1 min. MICRO 100P
5. Fill the mushrooms with the bacon mixture and place in the sauce. Place the dish into the glass tray in lower position (position 2) and cook.
8 - 10 min. COMBI HIGH 50P
Allow the mushrooms to stand for approximately 2 minutes once cooked.

Procedure

1. Put the water, oil and salt in the dish and bring to the bowl on the centre of the oven floor (position 1) with the lid on.
3 - 4 min. MICRO 100P
2. Break the macaroni into pieces, add to the dish, stir and allow to swell.
9 - 11 min. MICRO 30P
Drain the macaroni and allow to cool.
3. Mix the tomatoes with the onions and season well. Grease the gratin dish. Put the macaroni in it and pour the tomato sauce over it. Arrange the courgette slices on the top.
4. Beat the sour cream with the eggs and pour over the mixture in the dish. Sprinkle the grated cheese over the top. Place the gratin dish into the glass tray in lower position (position 2).
21 - 23 min. COMBI LOW 50P
Allow the dish to stand for 5-10 minutes after cooking.

RECIPES

STUFFED ROAST CHICKEN

Austria : Gefülltes Brathähnchen

Stuffed roast chicken for two servings

Total cooking time: approx. 34 - 42 minutes

Utensils: Small bowl with lid

Thread

Ingredients

- 1 Chicken (1000 g)
- Salt, bruised (fresh) rosemary, bruised Marjoram
- 1 Stale bread roll (40 g)
- Salt
- 1 bunch Parsley, finely chopped (10 g)
- 1 pinch Nutmeg
- 2 tbsp Butter or margarine (20 g)
- 1 Egg yolk
- 3 tbsp Butter or margarine (30 g)
- 1 tsp Paprika, mild
- Salt
- 1 tsp Butter or margarine to grease the dish

FISH FILLET WITH CHEESE SAUCE

Switzerland : Fischfilet mit Käsesauce

Total cooking time: approx. 20 - 25 minutes

Utensils: Bowl with lid (1 litre capacity)

Shallow round gratin dish
(approx. 25 cm diameter)

Ingredients

- 3 Fish fillets (approx. 600 g)
- 2 tbsp Lemon juice
- Salt
- 1 tbsp Butter or margarine
- 1 Onion (50 g), finely chopped
- 2 tbsp Flour (20 g)
- 100 ml White wine
- 1 tsp Vegetable oil to grease the dish
- 100 g Grated Emmental cheese
- 2 tsp Chopped parsley

POT ROAST WITH GREEN BEANS

Greece : Kréas mé fasólia

Total cooking time: approx. 14 - 18 minutes

Utensils: Bowl with lid (2 litre capacity)

Ingredients

- 1-2 Tomatoes (100 g)
- 400 g Lamb without bones
- 1 tsp Butter or margarine to grease the dish
- 1 Onion (50 g), finely chopped
- 1 Clove of garlic, crushed
- Salt and pepper
- Sugar
- 250 g Tinned green beans

Procedure

1. Wash the chicken, pat it dry and season the cavity with salt, rosemary and marjoram.
2. To make the filling, soak the bread roll for approximately 10 minutes in cold water, and then squeeze out excess water. Mix butter and egg yolk with salt, parsley, nutmeg, and stuff the chicken with the mixture. Sew the opening with cotton or butcher's thread.
3. Heat the butter in the small bowl on the centre of the oven floor (position 1) with the lid on.
approx. 1 min. MICRO 100P
Mix the paprika and salt with the butter and smear it on the chicken.
4. Place the chicken breast side down on the rack into the glass tray and cook.
 1. **10 - 12 min.** MICRO 100P
 2. **6 - 8 min.** COMBI HIGH 30P
Turn the chicken over
 3. **12 - 14 min.** MICRO 100P
 4. **5 - 7 min.** COMBI HIGH 30P
Allow the stuffed chicken to stand for approximately 3 minutes after cooking.

Procedure

1. Wash the fish, pat dry and sprinkle with lemon juice. Leave to stand for 15 minutes, pat dry again and rub with salt.
2. Smear the butter on the bottom of the dish. Add the diced onion, cover with the lid and cook on the centre of the oven floor (position 1).
1 - 2 min. MICRO 100P
3. Sprinkle the flour over the onions and stir. Add the white wine and mix.
4. Grease the gratin dish and place the fish in it. Pour the sauce over the fish and sprinkle with cheese. Place the gratin dish into the glasstray in lower position (position 2) and cook.
7 - 8 min. MICRO 70P
12 - 15 min. COMBI HIGH 30P
Allow fish to stand for approximately 2 minutes after cooking. Serve with a garnish of chopped parsley

Procedure

1. Peel the tomatoes, cut out the stalks and purée in a food processor.
2. Cut the lamb into large cubes. Grease the dish with butter. Add the meat, the diced onion and crushed garlic clove, season, cover dish and cook on the centre of the oven floor (position 1).
6 - 8 min. MICRO 100P
3. Add the beans and the puréed tomatoes to the meat and continue to cook with the lid on.
8 - 10 min. MICRO 70P
Allow the meat to stand for approximately 5 minutes after cooking.

Tip: If you use fresh beans, these must be cooked in advance.

ENGLISH



RECIPES

STUFFED HAM

Spain : Jamón relleno

Total cooking time: approx. 20 - 24 minutes

Utensils: Bowl with lid (2 litre capacity)

Shallow oval gratin dish with lid
or microwave foil
(approx. 26 cm long)

Ingredients

125 g Fresh spinach, with stalks removed
 125 g Quark (6% fat)
 40 g Grated Emmental cheese
 Pepper
 Paprika, mild
 6 Slices cooked ham (300 g)
 125 ml Water
 125 ml Cream
 2 tbsp Flour (20 g)
 2 tbsp Butter or margarine (20 g)
 1 tsp Butter or margarine to grease the dish

Procedure

1. Cut the spinach finely, mix with the quark and the cheese and season to taste.
2. Place a tablespoon of the filling on each slice of the cooked ham and roll up. Secure the ham with a wooden toothpick.
3. Make a béchamel sauce. To do this, pour the liquid into the dish, cover and heat on the centre of the oven floor (position 1).
3 - 4 min. MICRO 100P
 Rub the butter into the flour, add to the liquid and beat with a balloon whisk, until it is smooth. Cover, bring to the boil until thickened.
approx. 1 min. MICRO 100P
 Stir and taste.
4. Pour the sauce into the greased dish, place the ham rolls in the dish. Place the dish into the glass tray in lower position (position 2) and cook.
16 - 19 min. COMBI HIGH 30P
 Allow the ham rolls to stand for approximately 5 minutes after cooking.

Tip: You can also use ready-made béchamel sauce for this recipe.

ZURICH VEAL STEW

Switzerland : Züricher Geschnätzlettes

Total cooking time: approx. 9 - 13 minutes

Utensils: Bowl with lid (2 litre capacity)

Ingredients

600 g Veal fillet
 1 tbsp Butter or margarine
 1 Onion (50 g), finely chopped
 100 ml White wine
 Gravy thickener to make approx. 1/2 litre
 300 ml Cream
 Salt and pepper
 1 tbsp Parsley, chopped

Procedure

1. Slice the meat into finger-thick strips.
2. Smear the butter evenly around the dish. Add the onion and the meat to the dish, cover and cook on the centre of the oven floor (position 1). Stir once during cooking.
6 - 8 min. MICRO 100P
3. Add the white wine, the gravy powder and the cream, stir, cover and continue to cook. Stir once during cooking.
3 - 5 min. MICRO 100P
4. Taste the stew, stir again and allow to stand for 5 minutes. Serve with parsley garnish.

RECIPES

FILET OF SOLE

France : Filets de sole or 2 Portions

Total cooking time: approx. 13 - 15 minutes

Utensils: Shallow oval gratin dish with lid or microwave foil (approx.26 cm)

Ingredients

- 400 g Filet of sole
- 1 Lemon, untreated
- 2 Tomatoes (150 g)
- 1 tsp Butter or margarine to grease the dish
- 1 tbsp Vegetable oil
- 1 tbsp Parsley, chopped
- Salt and pepper
- 4 tbsp White wine (30 ml)
- 2 tbsp Butter or margarine (20 g)

PRAWNS WITH CHILLI

Total cooking time: approx. 5 - 7 minutes

Utensils: Bowl with lid (1 litre capacity)

Bowl with lid (2 litre capacity)

Ingredients



- 6 Prawns (shelled 240 g)
- 50 ml White wine
- 2 Small bunches of chives (200 g)
- 1-2 Chillies, hot
- 20 g Ginger (fresh)
- 1 tbsp Cornflour
- 2 tbsp Vegetable oil (20 g)
- 1/2 tbsp Soy sauce (20 ml)
- 1 tbsp Sugar
- 1 tbsp Vinegar

Procedure

1. Wash the fish and pat dry. Remove any bones.
2. Slice the lemon and the tomatoes finely.
3. Grease the gratin dish with butter. Place the fish in it and drizzle with vegetable oil.
4. Sprinkle the fish with parsley, lay the slices of tomato on top and season. Lay the slices of lemon on top of the tomato and pour the white wine over this.
5. Dot the lemon with butter, cover and cook on the centre of the oven floor (position 1).
13 - 15 min.  MICRO 50P
Leave the fish fillets to stand for about 2 minutes after cooking.

Tip: You can also use rosefish, halibut, mullet, plaice or cod in this recipe.

Procedure

1. Wash the prawns. Remove the shell and tail. Cut into the spine and remove gut. Cut each prawn into 2 or 3 pieces and snip each piece so they do not curl when cooked. Put the prawns into a bowl and sprinkle with the wine. Cover and marinate.
2. Wash chives and chillies and pat dry. Cut chives into 5cm lengths. Cut chillies in half lengthwise and remove seeds. Peel and slice ginger.
3. Take the prawns out of the wine and coat them in cornflour.
4. Put oil, chives, chillies and ginger slices into bowl and cover. Heat on the centre of the oven floor (position 1).
approx. 2 min.  MICRO 100P
5. Add prawns to the bowl. Season with soy sauce, sugar and vinegar. Stir and cook covered.
3 - 5 min.  MICRO 100P
Allow the prawns to stand for 1 - 2 minutes after cooking. Serve hot.

Vegetables and noodles

VEGETABLE CASSEROLE

France : Ratatouille spécial

Total cooking time: approx. 15 - 18 minutes

Utensils: Bowl with lid (2 litre capacity)

Ingredients

- 5 tbsp Olive oil (50 ml)
- 1 Garlic clove, crushed
- 1 Onion (50 g), sliced
- 1 Small aubergine (250 g), roughly chopped
- 1 Courgette (200 g), roughly chopped
- 1 Pepper (200 g), roughly chopped
- 1 Small fennel bulb (75 g), roughly chopped
- Pepper
- 1 Bouquet garni
- 200 g Tin artichoke hearts, quartered
- Salt and pepper

Procedure

1. Put olive oil and garlic in dish. Add all the prepared vegetables except the artichoke hearts and season with pepper. Add the bouquet garni and cook covered on the centre of the oven floor (position 1). Stir once during cooking.
15 - 18 min.  MICRO 100P
Add the artichoke hearts to the bowl for the last 5 minutes.
2. Season the ratatouille to taste and take the bouquet garni out before serving. Once cooked, leave the ratatouille to stand for about 2 minutes.

Tip: Serve this hot vegetable casserole with meat dishes. Served cold it makes a delicious starter.

Bouquet garni consists of: a sprig each of parsley, lovage and thyme, plus some bay leaves.

RECIPES

LASAGNE

Italy : Lasagne al forno

Total cooking time: approx. 23 - 28 minutes

Utensils: Bowl with lid (2 litre capacity)

Shallow rectangular gratin dish
(approx. 20x20x6 cm)

Ingredients

300 g	Tomatoes, tinned
50 g	Ham, finely diced
1	Onion (50 g), finely chopped
1	Garlic clove, crushed
250 g	Minced beef
2 tbsp	Tomato puree (30 g)
	Salt and pepper
	Oregano, thyme, basil
150 ml	Crème fraîche
100 ml	Milk
50 g	Grated Parmesan cheese
1 tsp	Chopped mixed herbs
1 tsp	Olive oil
	Salt, pepper and nutmeg
1 tsp	Vegetable oil for greasing dish
125 g	Green lasagne sheets
1 tsp	Grated Parmesan cheese
1 tsp	Butter or margarine

STUFFED POTATOES

Spain : Patatas Rellenas

Total cooking time: approx. 10 - 14 minutes

Utensils: Bowl with lid (2 litre capacity)

China plates

Ingredients

4	Medium-sized potatoes (400 g)
100 ml	Water
60g	Ham, finely diced
1/2	Onion (25 g), finely chopped
75-100 ml	Milk
2 tbsp	Grated Parmesan cheese (20 g)
	Salt
	Pepper
2 tbsp	Grated Emmental cheese

Drink and Desserts

PEARS IN CHOCOLATE SAUCE

France : Poires au chocolat

Total cooking time: approx. 8 - 14 minutes

Utensils: Bowl with lid (2 litre capacity)

Bowl with lid (1 litre capacity)

Ingredients

4	Pears (600 g)
60 g	Sugar
1	Packet of vanilla sugar (10 g)
1 tbsp	Pear liqueur, 30% proof
150 ml	Water
130 g	Plain chocolate, broken into pieces
100 g	Crème fraîche

Procedure

1. Slice the tomatoes and mix with the diced onion and ham, garlic, minced beef and tomato puree. Season, cover the dish and cook on the centre of the oven floor (position 1). Stir once during cooking.

6 - 8 min. MICRO 100P

2. Mix together the cream, milk, Parmesan cheese, herbs and oil. Season.

3. Grease the dish and cover the base with 1/3 of the pasta sheets. Spread half of the meat mixture on top of the pasta and cover with some of the cheese sauce. Lay another 1/3 of the pasta on top of this, followed by the meat mixture and some sauce. Finish with the last 1/3 of the pasta covered with a lot of sauce and top with grated Parmesan. Place butter flakes on top. Place the gratin dish into the glass tray in lower position (position 2) and cook.

17 - 20 min. COMBI LOW 50P

Leave the lasagne 5 to 10 minutes to stand after cooking.

Procedure

1. Put the potatoes in the bowl, add the water, cover and cook on the centre of the oven floor (position 1). Turn once during cooking.

7 - 9 min. MICRO 100P

Allow to cool.

2. Halve the potatoes lengthways and carefully scoop out the flesh. Mix the potato with the ham, onion, milk and Parmesan until it is smooth. Season with salt and pepper.
3. Fill the potato skins with the mixture, top with the grated Emmental, place on the plates and cook on the centre of the oven floor (position 1).

3 - 5 min. MICRO 100P

Leave the potatoes to stand for about 2 minutes after cooking.

Procedure

1. Peel the pears, keeping them whole.
2. Put sugar, vanilla sugar, liqueur and water into the bowl. Stir and heat on the centre of the oven floor (position 1).

1 - 2 min. MICRO 100P

3. Place the pears in the juice, cover and cook on the centre of the oven floor (position 1).

8 - 10 min. MICRO 100P

Take the pears out of the juice and allow to cool.

4. Put 50 ml of the juice in the small bowl, add the cream and chocolate. Cover and heat on the centre of the oven floor (position 1).

1 - 2 min. MICRO 100P

5. Stir the sauce well and pour over the pears to serve.

Tip: You could also serve this with vanilla ice cream.

RECIPES



BERRY JELLY WITH VANILLA SAUCE

Denmark : Rødgrød med vanilie sovs
Total cooking time: approx. 8 - 11 minutes
Utensils: 2 dishes with lids (2 litre capacity)

Ingredients

150 g	Redcurrants, washed, stems and stalks removed
150 g	Strawberries, washed, stalks removed
150 g	Raspberries, washed and checked
250 ml	White wine
100 g	Sugar
50 ml	Lemon juice
8	Gelatine sheets
300 ml	Milk
	Flavouring from ½ vanilla pod
30 g	Sugar
15 g	Cornflour

Procedure

1. Reserve some of the fruit for decoration. Puree the rest of the berries with the wine. Put into the bowl, cover and cook on the centre of the oven floor (position 1).
5 - 7 min.  MICRO 100P
Add sugar and lemon juice.
2. Leave gelatine in cold water for 10 minutes to soften. Remove and squeeze out water. Stir gelatine into the hot fruit until it dissolves. Put the jelly into the fridge to set.
3. To make the vanilla sauce, put the milk in a bowl. Slice the vanilla pod open and scrape out the vanilla flavouring. Stir the flavouring, sugar and cornflour into the milk and cover before cooking. Cook on the centre of the oven floor (position 1). Stir occasionally during cooking and to finish.
3 - 4 min.  MICRO 100P
4. Tip the set jelly onto a plate and garnish with the whole berries. Serve with the vanilla sauce.

Tip: You can also use frozen fruit once it is defrosted.

ENGLISH

FIERY DRINK

Niederlande : Vuurdrank for 10 Portions
Total cooking time: approx. 8 - 10 minutes
Utensils: Bowl with lid (2 litre capacity)

Ingredients

500 ml	White wine
500 ml	Red wine, dry
500 ml	Rum, 54% proof
1	Whole orange, untreated
3	Cinnamon sticks
75 g	Sugar
10 tsp	Rock candy

Procedure

1. Pour the alcohol into the bowl. Peel the orange so that the peel is thin and put this in the alcohol together with the cinnamon and sugar. Cover and heat on the centre of the oven floor (position 1).
8 - 10 min.  MICRO 100P
Remove the peel and cinnamon. Put one teaspoon of the rock candy into each grog glass, top up with the fiery drink and serve.

CHOCOLATE WITH CREAM

Österreich : Schokolade mit Schlagobers for 1 Portion
Total cooking time: approx. 1 - 1½ minutes
Utensils: large cup (200 ml capacity)

Ingredients

150 ml	Milk
30 g	Plain chocolate, grated
30 ml	Cream
	Chocolate vermicelli

Procedure

1. Pour the milk into the cup. Add the chocolate, stir and heat on the centre of the oven floor (position 1). Stir occasionally.
approx. 1 - 1½ min.  MICRO 100P
2. Whip the cream until stiff and spoon this on top of the chocolate. Serve garnished with chocolate vermicelli.

HOT LEMON

Deutschland : Heisse Zitrone for 1 Portion
Total cooking time: approx. 1 - 1½ minutes
Utensils: Tea glass (150 ml capacity)

Ingredients

100 ml	Water
	Juice of 1 lemon
2-3 tsp	Sugar

Procedure

1. Pour water and lemon juice into the glass and heat on the centre of the oven floor (position 1).
approx. 1 - 1½ min.  MICRO 100P
Stir in sugar to taste.

RECIPES

ASPARAGUS SOUFFLÉS

For 2 servings

Total cooking time: approx. 25 minutes

Utensils: Bowl with 0.5 litre capacity

4 Ramekin dishes (diameter approx. 8cm)

Glass tray

Steam tray

Ingredients

50 g Mushrooms, roughly chopped
25 g Smoked ham, finely diced
170 g Bottled asparagus (save the liquid)
1 Tomato (60g), quartered
25 g Sour cream
50 ml Asparagus liquid
1 tsp Plain flour
1 Egg yolk
1 Egg white
Salt, pepper, ground nutmeg
Butter to grease the dishes

Procedure

1. Mix together in a small bowl the sour cream, asparagus liquid, flour and seasonings. Heat on the centre of the oven floor (position 1). Stir once during heating.

50 sec.  MICRO 100P

Then allow the sauce to cool.

2. Grease the ramekin dishes. Beat the egg white until stiff peaks form.

3. Trim 5 asparagus spears per dish to about 1cm higher than the dish. Arrange the spears around the rim of each dish. Cut the trimmed sections into thin slices.

4. Mix the egg yolk into the cooled sauce. Add the mushrooms, ham and asparagus slices and mix well. Finally, fold in the egg white.

5. Spoon the mixture into the dishes to just under the rim. Place a tomato segment on top of each. Place the ramekin dishes into the steam tray on the glass tray in lower position (position 2).

25 min.  STEAM HIGH Position 2

HIGH

BACON RISOTTO

Total cooking time: approx. 35 minutes

Utensils: Shallow, oval ovenproof dish (diameter 22cm)

Glass tray

Steam tray

Ingredients

50 g Smoked, streaky bacon, finely diced
50 g Onion, finely chopped
200 g Round-grain (Arborio) rice
300 ml Meat stock (cold)
70 g Grated Swiss Brinz cheese (alternatively grated Emmentaler)
1 pinch Saffron
Salt, pepper

Procedure

1. Place the diced bacon and chopped onion in the dish.

2. Add the rice and the stock, and mix well. Place the dish into the steam tray on the glass tray in lower position (position 2).

35 min.  STEAM HIGH Position 2

3. Mix in the cheese and saffron and season to taste.

Tip: Accompany with sautéed chanterelle or cultivated white mushrooms and a mixed salad.

BREAD DUMPLINGS

Total cooking time: approx. 25 minutes

Utensils: 5 cups or pudding dishes

Small bowl with lid

Glass tray

Steam tray

Ingredients

20 g Butter or margarine
50 g Onion, finely chopped
About 500 ml Milk
200 g Dried bread cubes (from about 5 bread rolls)
3 Eggs
Butter to grease the cup

Procedure

1. Place the butter and the onion into the small bowl and cover. Place the bowl on the centre of the oven floor (position 1) and cook.

approx. 2 min.  MICRO 100P

2. Cut the bread rolls into rough cubes, cover with the milk and allow to stand for 10 minutes. Beat the eggs.

3. Mix the onion, eggs and softened bread to a smooth dough. Add a little more milk if necessary.

4. Lightly grease the cups with butter and divide the dough equally among 5 cups. Place the cups into the steam tray on the glass tray in lower position (position 2) and cook.

25 min.  STEAM HIGH Position 2

Allow the dumplings to stand for about 5 minutes in the oven without opening the door.

5. Turn the dumplings out onto a plate to serve.

• SEULEMENT VALIDE POUR L'ALLEMAGNE ET L'AUTRICHE • SLECHTS GELDIG VOOR DUITSLAND EN OOSTENRIJK •
ONLY VALID FOR GERMANY AND AUSTRIA •

Vorgehensweise bei Vorliegen eines Produktmangels:

- Wurde Ihr Gerät durch einen Fachbetrieb mit einem von Sharp genehmigten Einbaurahmen oder rahmenlos ein-/untergebaut, können Sie die unter **Ziffer 1. aufgeführten Garantieansprüche im Rahmen des Quick 48 Vor-Ort-Service** geltend machen und sich direkt an den **KUNDEN-SERVICE wenden oder Sachmängel gegenüber Ihrem Verkäufer geltend machen.**
- Für alle übrigen Geräte können Sie die unter **Ziffer 2. aufgeführten Garantieansprüche ohne Quick 48 Stunden Vor-Ort-Service** oder Sachmängel gegenüber Ihrem Verkäufer geltend machen.

DER SHARP KUNDEN-SERVICE



Sie erreichen die Service-Hotline:
montags bis freitags zwischen 8 und 18 Uhr
in Österreich: **0820 - 500 820** (€ 0,145/Min.)
in Deutschland: **0180 - 5 23 46 74**
(0,14 €/Min. aus dem deutschen Festnetz,
max. 0,42 €/Min. aus dem deutschen Mobilfunknetz)

1. Garantie mit Quick 48 Stunden Vor-Ort-Service Gilt für Deutschland und Österreich

Haushalts-Mikrowellengeräte im Quick 48 Stunden Vor-Ort-Service

Sehr geehrter Sharp Kunde,

alle ein-/ untergebauten Haushalts-Mikrowellengeräte, die durch einen Fachbetrieb fachgerecht mit einem von SHARP genehmigten Einbaurahmen oder rahmenlos ein-/ bzw. untergebaut worden sind, werden im Quick 48 Vor-Ort-Service abgewickelt. Die in dieser Garantie beschriebenen Ansprüche stehen Ihnen zusätzlich neben den gesetzlichen Sachmängelansprüchen gegen Ihren Verkäufer zu.

Umfang der Garantie: Sollte Ihr Mikrowellengerät trotz sorgfältiger Herstellung und Endkontrolle einen Mangel aufweisen, können Sie innerhalb der Garantiezeit, Garantieleistungen gegen Sharp Electronics (Europe) GmbH in Anspruch nehmen. Diese stehen Ihnen zu, wenn ein herstellungsbedingter Material- und/oder Verarbeitungsmangel (nachfolgend „Mangel“) bei dem Mikrowellengerät oder Teilen davon - mit Ausnahme der Garraum-Glühlampe - innerhalb von 24 Monaten auftritt. Die Garantie umfasst nicht Mängel, die durch unsachgemäße Behandlung, Bedienungsfehler oder durch Fremdeinwirkung entstanden sind. Transportschäden bei Neugeräten müssen Sie bei Ihrem Verkäufer geltend machen. Die Garantiefrist von 24 Monaten beginnt mit dem Tag, an dem Sie das fabriktreue Gerät von einem Händler gekauft haben. Die Erbringung von Garantieleistungen verlängert nicht die Garantiezeit.

Garantieleistungen: Sharp Electronics (Europe) GmbH erfüllt seine Garantieverpflichtungen für Mängel durch kostenlose Reparatur und einen **Quick 48 Stunden Vor-Ort-Service**. Etwa anfallende Transportkosten innerhalb Deutschlands und Österreich übernehmen wir.

Im Quick 48 Stunden Vor-Ort-Service werden alle Reklamationen, die montags bis freitags zwischen 8:00 und 18:00 Uhr beim Quick 48 Deutschland, **Tel.: 0180 / 5 23 46 74** *(0,14 €/Min. aus dem deutschen Festnetz, max. 0,42 €/Min. aus dem deutschen Mobilfunknetz) und in Österreich **Tel.: 0820 / 500 820** *(€ 0,145/Min) eingehen, ab dem darauffolgenden Werktag gerechnet, im Regelfall innerhalb 48 Stunden bei Ihnen im Vor-Ort-Service repariert.

Geltendmachung der Garantie: Der Mangel des Gerätes muss innerhalb der Garantiefrist unter Angabe des Kaufdatums, der Modellbezeichnung und der Seriennummer des Gerätes unter den oben aufgeführten Telefonnummern geltend gemacht werden. Bei der Vor-Ort-Reparatur ist dann der Kaufbeleg, aus dem sich das Kaufdatum, die Modellbezeichnung und die Seriennummer des Gerätes ergibt, vorzulegen.

Achtung:

Wird dieser Service für von Ihnen **selbst ein-/untergebaute** Geräte in Anspruch genommen, sind für Aus-/und Einbau, Fahrzeit und Km die entstehenden Kosten von Ihnen zu tragen!

Bitte erkundigen Sie sich vor Anforderung des Kundendienstes bei diesem über die anfallenden Kosten. Den für Sie nächstgelegenen Kundendienst nennt Ihnen gern unsere o.g. Hotline.

Als Nachweis für Sachmängel-/ Garantiarbeiten dient Ihr Kaufbeleg / Rechnung.

Selbstverständlich können Sie unseren QUICK 48 Vor-Ort-Service für Mikrowellengeräte auch nach Ablauf der Verjährungsfristen für Sachmängel-/Garantiefristen in Anspruch nehmen, dann jedoch gegen Aufwandsberechnung des jeweiligen Kundendienstes.

Garantiegeber: SHARP Electronics (Europe) GmbH, Sonninstrasse 3, 20097 Hamburg
www.sharp.de



• SEULEMENT VALIDE POUR L'ALLEMAGNE ET L'AUTRICHE • SLECHTS GELDIG VOOR DUITSLAND EN OOSTENRIJK •
ONLY VALID FOR GERMANY AND AUSTRIA •

Vorgehensweise bei Vorliegen eines Produktmangels:

- **Wurde Ihr Gerät durch einen Fachbetrieb mit einem von Sharp genehmigten Einbaurahmen oder rahmenlos ein-/untergebaut, können Sie die unter Ziffer 1. aufgeführten Garantieansprüche im Rahmen des Quick 48 Vor-Ort-Service geltend machen und sich direkt an den KUNDEN-SERVICE wenden oder Sachmängel gegenüber Ihrem Verkäufer geltend machen.**
- **Für alle übrigen Geräte können Sie die unter Ziffer 2. aufgeführten Garantieansprüche ohne Quick 48 Stunden Vor-Ort-Service oder Sachmängel gegenüber Ihrem Verkäufer geltend machen.**

2. Garantie ohne Quick 48 Stunden Vor-Ort-Service

Gilt für Deutschland und Österreich

Haushalts - Mikrowellengeräte

Wichtiger Endkunden – Hinweis: Serviceabwicklung nur über den Verkäufer. Die in dieser Garantie beschriebenen Ansprüche stehen Ihnen zusätzlich neben den gesetzlichen Sachmängelansprüchen gegen Ihren Verkäufer zu.

Sehr geehrter SHARP Kunde,

SHARP-Geräte sind Markenartikel, die mit Präzision und Sorgfalt nach modernen Fertigungsmethoden hergestellt werden. Bei sachgemäßer Handhabung und unter Beachtung der Bedienungsanleitung wird Ihnen Ihr Gerät lange Zeit gute Dienste leisten. Das Auftreten von Fehlern ist aber nie auszuschließen. Sollte Ihr Gerät innerhalb der gesetzlichen oder mit Ihrem Verkäufer vereinbarten Verjährungsfristen für Sachmängel-/Garantiefristen einen Mangel aufweisen und das Gerät wurde **nicht von Ihrem Handelspartner ein-/untergebaut**, so wenden Sie sich bitte an den Verkäufer, bei dem Sie das Gerät erworben haben und geben Sie das defekte Gerät dort ab, denn dieser ist Ihr Ansprechpartner für Sachmängel.

Umfang der Garantie: Sollte Ihr Mikrowellengerät trotz sorgfältiger Herstellung und Endkontrolle einen Mangel aufweisen, können Sie innerhalb der Garantiezeit, Garantieleistungen gegen Sharp Electronics (Europe) GmbH in Anspruch nehmen. Diese stehen Ihnen zu, wenn ein herstellungsbedingter Material- und/oder Verarbeitungsmangel (nachfolgend „Mangel“) bei dem Mikrowellengerät oder Teilen davon - mit Ausnahme der Garraum-Glühlampe - innerhalb von 24 Monaten auftritt. Die Garantie umfasst nicht Mängel, die durch unsachgemäße Behandlung, Bedienungsfehler oder durch Fremdeinwirkung entstanden sind. Transportschäden bei Neugeräten müssen Sie bei Ihrem Verkäufer geltend machen. Die Garantiefrist von 24 Monaten beginnt mit dem Tag, an dem Sie das fabrikanneue Gerät von einem Händler gekauft haben. Die Erbringung von Garantieleistungen verlängert nicht die Garantiezeit.

Garantieleistung:

Sharp Electronics (Europe) GmbH erfüllt seine Garantieverpflichtung für Mängel nach seiner Wahl durch kostenlose Reparatur oder durch Austausch des mangelhaften Gerätes gegen ein mangelfreies. Etwa anfallende Transportkosten innerhalb Deutschlands und Österreich werden von uns übernommen.

Geltendmachung der Garantie:

Um die Garantie in Anspruch nehmen zu können, benötigen Sie den Kaufbeleg (Rechnung, Quittung) aus dem sich das Kaufdatum, die Modellbezeichnung und Seriennummer des Gerätes ergibt. Der Mangel des Gerätes muss innerhalb der Garantiefrist von Ihnen gegenüber einem Sharp Service-Partner oder einem autorisierten Händler von Sharp Electronics (Europe) GmbH geltend gemacht werden. Bei weiteren Fragen wenden Sie sich bitte von montags bis freitags zwischen 8:00 und 18:00 Uhr an **unsere Service-Hotline 01805-29 95 29 *** (0,14 €/Min. aus dem deutschen Festnetz, max. 0,42 €/Min. aus dem deutschen Mobilfunknetz)

Selbstverständlich können Sie unseren Kundendienst für Sharp-Mikrowellengeräte auch nach Ablauf der Verjährungsfristen für Sachmängel-/Garantiefristen in Anspruch nehmen, dann jedoch gegen Aufwandsberechnung des jeweiligen Kundendienstes.

**Garantiegeber: SHARP Electronics (Europe) GmbH, SonninstraÙe 3, 20097 Hamburg
www.sharp.de**



• ADRESSES DES SAV • ONDERHOUDSADRESSEN •

BELGIUM - <http://www.sharp.be>

En cas d'une réclamation concernant une four à micro-onde SHARP, nous vous prions de vous adresser à votre spécialiste ou à une adresse des SHARP Services suivantes.

Indien uw magnetron problemen geeft kunt u zich wenden tot uw dealer of een van de onderstaande Sharp service centra.

SHARP ELECTRONICS, Phone: 0900-10158

AVTC, Kleine Winkellaan 54, 1853 Strombeek-Bever, 02/2674019 / **ETS HENROTTE**, Rue Du Campinaire 154, 6240 Farciennes, 071/396290 / **Nouvelle Central Radio (N.C.R)**, Rue des Joncs 15 L-1818 HOWALD, 00352404078 / **Service Center Deinze**, Kapellestraat, 95, 9800 DEINZE, 09-386.76.67

NEDERLAND - <http://www.sharp.nl>

Indien uw magnetron problemen geeft kunt u zich wenden tot uw dealer of naar onderstaand Sharp Service Centrum.

SHARP ELECTRONICS BENELUX BV, Helpdesk -, Postbus 900, 3990 DW Houten, 0900-7427723

FRANCE - <http://www.sharp.fr> centralized hotline = 0820 856 333

En cas de réclamation pour les fours micro-ondes SHARP, nous vous prions de vous adresser à votre spécialiste ou à l'une des stations techniques agréées SHARP suivantes:

A.A.V.I. : Rue des Bourreliers - Parc des Pyramides - ZAC Moulin Lambin 2 - 59320 Hallennes Lez Haubourdin ; Tél : 0892 236 246 ; Fax : 03.20.86.20.60 / **ATELIER ROUSSEL** : 12, Bld Flandre Dunkerque - 56100 Lorient ; Tél : 02.97.83.07.41 ; Fax : 02.97.87.02.36 / **MONSIEUR SAV** : 8 Av Noel Franchini - 20090 AJACCIO ; Tél : 04.95.23.67.63 ; Fax 04.95.23.67.67 / **ELECTRONIC SERVICE PLUS** : 5, bd LOUIS XI - ZI le Menneton - 37000 Tours ; Tél : 02.47.77.90.90 ; Fax : 02.47.77.90.91 / **ELECTRO SERVICE** : 21, rue de Mulhouse - B.P 122 - 68313 Illzach ; Tél : 0820 20 10 15 ; Fax : 03.89.50.80.14 / **ELECTRO TECH** : 26, Rue Cyrano - 69003 Lyon ; Tél : 0892 691 032 ; Fax : 04 72 33 18 90 / **M.R.T.** : 1-3, rue André CITROEN - 72000 Le Mans ; Tél : 02 22 66 50 20 ; Fax : 02 22 66 50 21 / **SETELEC** : 23, Rue de l'Argillère - 76420 Bihorel les Rouen ; Tél : 02.35.60.64.39 ; Fax : 02.35.59.93.48 / **S.T.E.** : 3, chemin de l'Industrie - 06110 Le Cannet Rocheville ; Tél : 04.93.46.05.00 ; Fax : 04.93.46.51.18 / **TECH SERVICE** : 15, rue du château de Ribaute - ZA Ribaute 2 - 31130 Quint Fonsegrives ; Tél : 05.62.57.63.90 ; Fax : 05.62.57.63.99 / **TIMO VIDEO** : 6, avenue des boutons d'or - Batiment A - Parc d'activité des petits carreaux - 94370 Sucy en Brie ; Tél : 01.43.39.08.18 ; Fax : 01.43.39.08.07

AjMadison
Your Appliance Authority™
800-570-3355



SHARP ELECTRONICS (Europe)
GmbH
Sonninstraße 3, D-20097 Hamburg
Germany

TINSEB287WRRZ-H02

Printed in Thailand

