

AJCQ12ACE

GE® ENERGY STAR® 115 Volt Built-in Cool-Only Room Air Conditioner

Wall Case Dimensions and Installation Information (in inches)

Note: When installing slide-out chassis units in through-the-wall applications, keep louvers free. Do not restrict air flow areas.

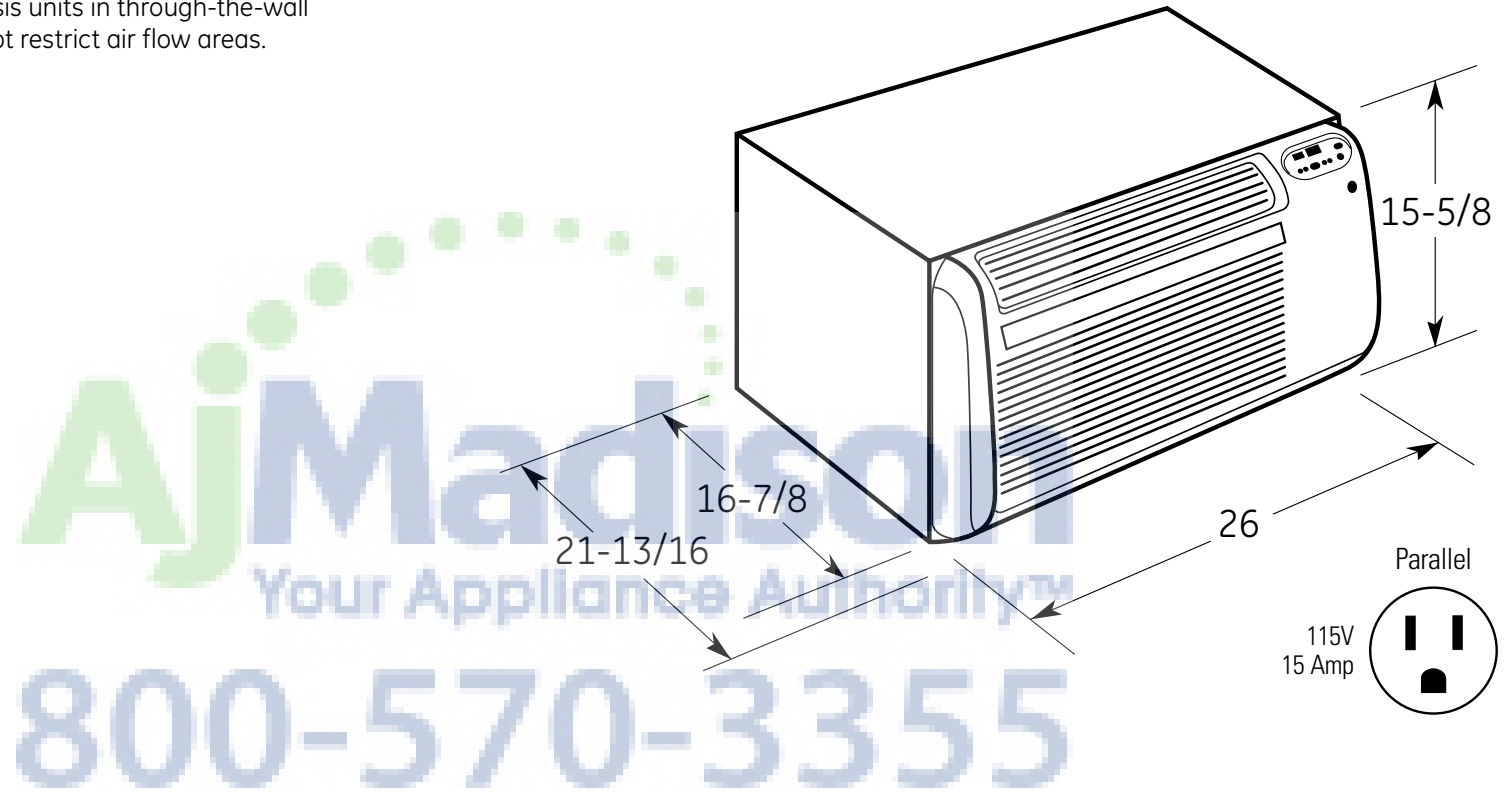

For answers to your Monogram®, GE Profile™ or GE® appliance questions, visit our website at geappliances.com or call GE Answer Center® service, 800.626.2000.



imagination at work



Total volume and shelf area are calculated by the Association of Home Appliance Manufacturers' standards.



Listed by Underwriters Laboratories

AJCQ12ACE

GE® ENERGY STAR® 115 Volt Built-in Cool-Only Room Air Conditioner

Dimensions (in inches)

Installation Information: A finished opening of 26-1/8" x 15-3/4" clear of intrusions is required. Keep clearance of 4" from side walls. Brick veneer or frame walls should have wood studding surrounding case to provide firm anchoring with screws. Case can be fastened directly to brick or block walls with screws sunk in lead expansion shields.

Note: Units should be caulked on all four sides of case to the building exterior to assure building integrity.

Two Wall Cases for Tenant Option Installation

When the air conditioner is offered as a tenant option, these wall cases provide protection against outside elements.

RAB47 – includes wall case, exterior grille and steel closure panels.

RAB48 – includes wall case, exterior grille, steel closure panel and two layers of insulation.

Standard Wall Case RAB46

Solid-sided wall case fabricated of galvanized steel with baked enamel finish. Welded areas are coated with a sealing compound to help resist rust and corrosion. Polymer gasket surrounds opening to assure tight weather seal. Aluminum grille (RAG13) is included. Panels on interior and between case and grille provide weather protection prior to installation of chassis. Provide firm anchoring with screws. Case can be fastened directly to brick or block walls with screws sunk in lead expansion shields.

For answers to your Monogram®, GE Profile™ or GE® appliance questions, visit our website at geappliances.com or call GE Answer Center® service, 800.626.2000.

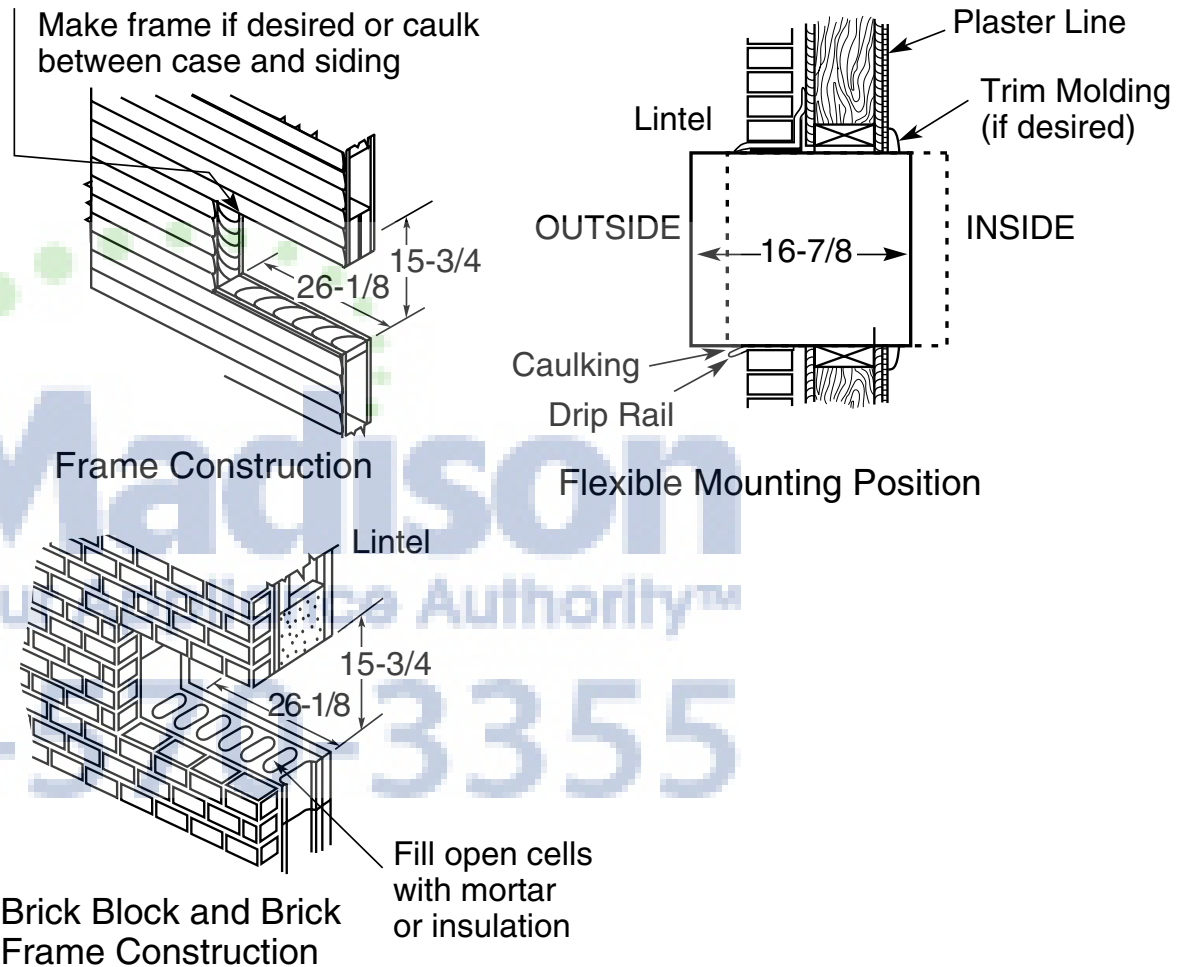

Total volume and shelf area are calculated by the Association of Home Appliance Manufacturers' standards.



Listed by Underwriters Laboratories

AJCQ12ACE

GE® ENERGY STAR® 115 Volt Built-in Cool-Only Room Air Conditioner

Features and Benefits

- GE® ENERGY STAR® 115 Volt Built-In Cool-Only Room Air Conditioner
- 12,000 Cooling BTU
- 9.8 EER
- 115 Volts
- ENERGY STAR® qualified
- R-410A refrigerant
- Electronic Controls with Remote
- Electronic Digital Thermostat
- Four-Way Air Direction
- Up-front, Washable Air Filter
- 3 cool / 3 fan speeds
- Unit dimensions: 14-7/8"W x 24-13/16"H x 19-29/32"D
- Model AJCQ12ACE – Soft Gray

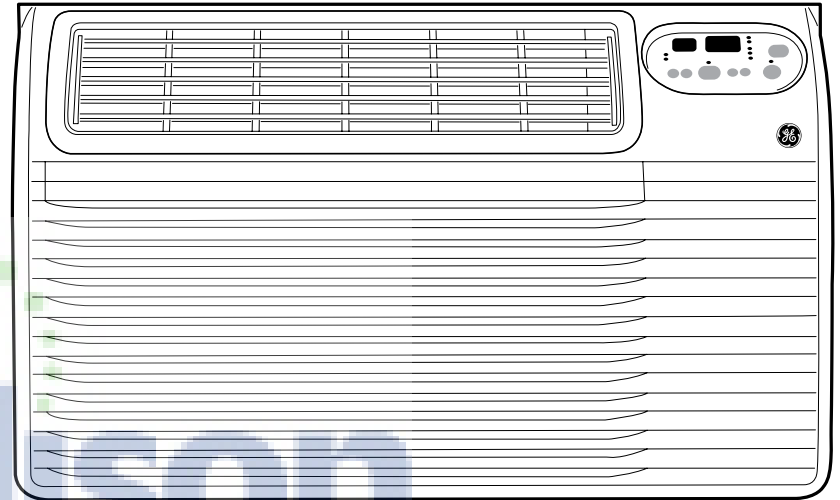

AiMadison
Your Appliance Authority™
800-570-3355



imagination at work