



REFRIGERATOR

use & care

| | | | |
|-----------------------------------|----|-----------------------------|----|
| Introduction..... | 2 | Ice Maker | 13 |
| Important Safety information..... | 3 | Controls and Settings | 14 |
| Features | 5 | Storage Features..... | 15 |
| Installation | 6 | Care and Cleaning | 17 |
| Door Removal..... | 8 | Troubleshooting | 19 |
| Water Supply Connection..... | 11 | Limited Warranty | 20 |

Welcome to our family

Thank you for bringing Frigidaire into your home! We see your purchase as the beginning of a long relationship together.

This manual is your resource for the use and care of your product. Please read it before using your appliance. Keep it handy for quick reference. If something doesn't seem right, the troubleshooting section will help you with common issues.

FAQs, helpful tips and videos, cleaning products, and kitchen and home accessories are available at Frigidaire.com.

We are here for you! Visit our website, chat with an agent, or call us if you need help. We may be able to help you avoid a service visit. If you do need service, we can get that started for you.

Let's make it official! Be sure to register your product.

Keep your product info here so it's easy to find.

Model Number _____
 Serial Number _____
 Purchase Date _____

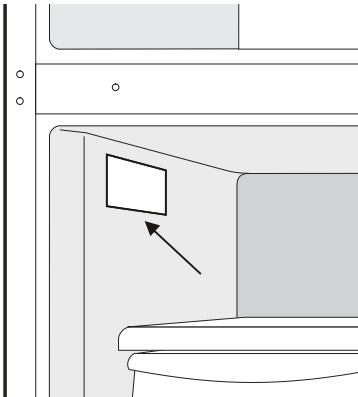

Serial Number Location



Installation Checklist

Doors

- Refrigerator door seals completely to cabinet on all sides
- Freezer door is level from side to side across the top

Leveling

- Refrigerator is level side-to-side and tilted 1/4" (6 mm) front-to-back
- Cabinet is set solid on all corners
- Anti-tip bracket set in front (both sides)

Electrical Power

- House power turned on
- Refrigerator plugged in

Ice Maker (some models)

- House water supply connected to refrigerator (Warning: Potable water supply only.)
- No water leaks present at all connections - recheck in 24 hours
- Ice maker is turned ON

Final Checks

- Shipping material removed
- Refrigerator and freezer temperatures set to recommended setting
- Crisper humidity controls set
- Registration card sent in



WARNING

Please read all instructions before using this appliance.

Safety Definitions

 This is the safety alert symbol. It is used to alert of potential personal injury hazards. Obey all safety messages that follow this symbol to avoid possible injury or death.



DANGER

DANGER indicates an imminently hazardous situation which, if not avoided, will result in death or serious injury.



WARNING

WARNING indicates a potentially hazardous situation which, if not avoided, could result in death or serious injury.



CAUTION

CAUTION indicates a potentially hazardous situation which, if not avoided, may result in minor or moderate injury.



IMPORTANT

IMPORTANT indicates installation, operation or maintenance information which is important but not hazard-related.



DANGER



DANGER Risk of fire or explosion. Flammable refrigerant used. Do not use mechanical devices to defrost refrigerator. Do not puncture refrigerant tubing.

DANGER Risk of fire or explosion. Flammable refrigerant used. To be repaired only by trained service personnel. Use only manufacturer-authorized service parts. Any repair equipment used must be designed for flammable refrigerants. Follow all manufacturer repair instructions. Do not puncture refrigerant tubing.



CAUTION



CAUTION Risk of fire or explosion. Dispose of refrigerator properly in accordance with the applicable federal or local regulations. Flammable refrigerant used.

CAUTION Risk of fire or explosion due to puncture of refrigerant tubing. Follow handling instructions carefully. Flammable refrigerant used.



WARNING

CALIFORNIA RESIDENTS ONLY
Cancer and Reproductive Harm
www.P65Warnings.ca.gov

Child Safety

This appliance is not intended for use by persons (including children) with reduced physical, sensory or mental capabilities, or lack of experience and knowledge, unless they have been given supervision or instruction concerning use of the appliance by a person responsible for their safety.

Destroy or recycle the carton, plastic bags, and any exterior wrapping material immediately after you unpack the refrigerator. Children should **NEVER** use these items to play. Cartons covered with rugs, bedspreads, plastic sheets or stretch wrap may become airtight chambers, and can quickly cause suffocation.

Safety Instructions

- DO NOT store or use gasoline, or other flammable liquids in the vicinity of this or any other appliance. Read product labels for warnings regarding flammability and other hazards.
- DO NOT operate the refrigerator in the presence of explosive fumes.
- Avoid contact with any moving parts of automatic ice maker.
- Remove all staples from the carton. Staples can cause severe cuts, and also destroy finishes if they come in contact with other appliances or furniture.



WARNING

Do not use electrical appliances inside the food storage compartments of the appliance unless they are of the type recommended by the manufacturer.

4

IMPORTANT SAFETY INFORMATION

Proper Disposal of your Appliance

Risk of child entrapment

Child entrapment and suffocation are not problems of the past. Junked or abandoned appliances are still dangerous – even if they will sit for “just a few days”. If you are getting rid of your old unit, please follow the instructions below to help prevent accidents.

We strongly encourage responsible appliance recycling/disposal methods. Check with your utility company or visit energystar.gov/recycle for more information on recycling your old appliance.

Before you throw away your old unit:

- Remove doors.
- Leave shelves in place so children may not easily climb inside.
- Have refrigerant removed by a qualified service technician.

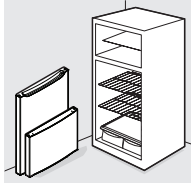

WARNING

Follow these guidelines to ensure safety mechanisms in this appliance will operate properly.

Electrical information

- Plug the unit into its own dedicated 115 Volt, 60 Hz., 15 Amp, AC only electrical outlet. The power cord of the appliance is equipped with a 3-prong grounding plug for your protection against electrical shock hazards. Plug it directly into a properly grounded 3-prong receptacle. You must install the receptacle in accordance with local codes and ordinances. Consult a qualified electrician. Avoid connecting the unit to a Ground Fault Interrupter (GFI) circuit. Do not use an extension cord or adapter plug.
- If the power cord is damaged, an authorized service technician should replace it to prevent any risk.
- Never unplug the refrigerator by pulling on the power cord. Always grip the plug firmly, and pull it straight out from the receptacle to prevent damaging the power cord.

- Unplug the appliance before cleaning and before replacing the AC LED light bulb to avoid electrical shock. Use only a 5-watt or less AC LED light bulb.
- Performance may be affected if the voltage varies by 10% or more. Operating the refrigerator with insufficient power can damage the compressor. Such damage is not covered under your warranty.
- Do not plug the unit into an electrical outlet controlled by a wall switch or pull cord to prevent the unit from being turned off accidentally.

Grounding type wall receptacle

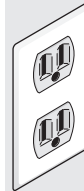

Do not, under any circumstances, cut, remove, or bypass the grounding prong.

Power cord with 3-prong grounded plug



IMPORTANT

CFC/HCFC Disposal

Your old refrigerator may have a cooling system that used CFCs or HCFCs (chlorofluorocarbons or hydrochlorofluorocarbons). CFCs and HCFCs are believed to harm stratospheric ozone if released to the atmosphere. Other refrigerants may also cause harm to the environment if released to the atmosphere.

If you are throwing away your old refrigerator, make sure the refrigerant is removed for proper disposal by a qualified technician. If you intentionally release refrigerant, you may be subject to fines and imprisonment under provisions of environmental legislation.

*Features may vary according to model

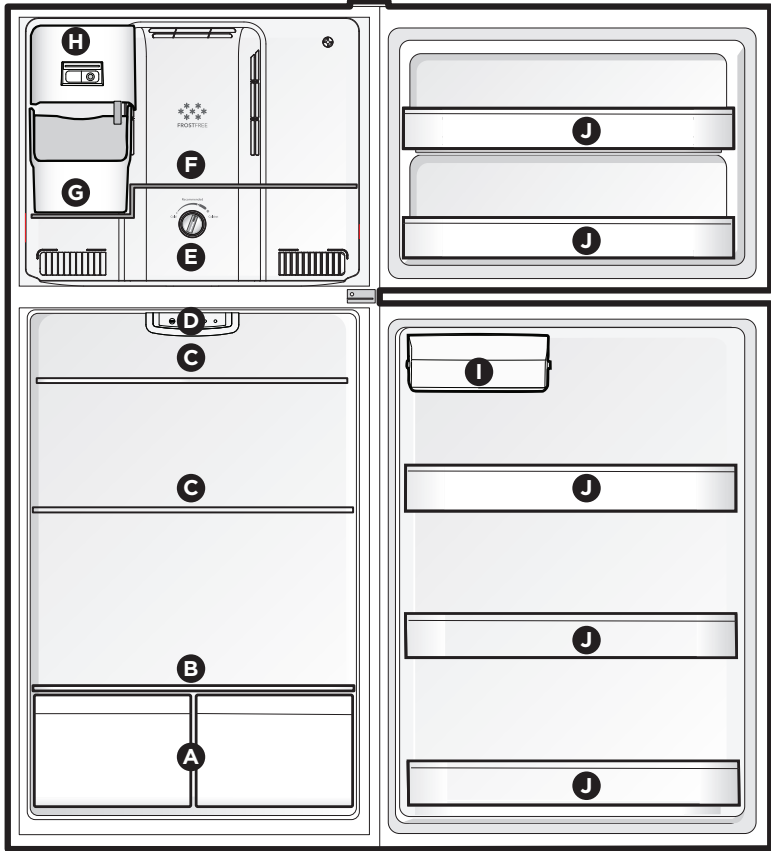

| | |
|----------|----------------------|
| A | Crisper Drawers |
| B | Crisper Cover |
| C | Full Shelves |
| D | Refrigerator Control |
| E | Freezer Control |

| | |
|----------|------------------------|
| F | Freezer Shelf |
| G | Ice Bucket* (optional) |
| H | Ice Maker* (optional) |
| I | Dairy Bin |
| J | Fixed Door Bins |



IMPORTANT

Accessories are available for your appliance and may be purchased at Frigidaire.com or by calling 1-800-374-4432 (Frigidaire.ca or 1-800-265-8352 in Canada) or from an authorized seller.

6

INSTALLATION

This Use & Care Guide provides general operating instructions for your model. Use the appliance only as instructed in this Use & Care Guide. Before starting the unit, follow these important first steps.



IMPORTANT

Cleaning your Refrigerator

Remove tape and glue residue from surfaces before turning the refrigerator on. Rub a small amount of liquid dish soap over the adhesive with your fingers. Rinse with warm water and dry with a soft cloth.

Do not use sharp instruments, rubbing alcohol, flammable fluids, or abrasive cleaners to remove tape or glue. These products can damage the surface of your refrigerator.

After you remove all of the package materials, clean the inside of your refrigerator before using it. See the **CARE AND CLEANING** section in this manual.



IMPORTANT

Moving your Refrigerator

Your refrigerator is heavy. When moving the refrigerator for cleaning or service, raise the anti-tip bracket (see "**Setting the Anti-tip Brackets**"). Also be sure to cover the floor with cardboard or hardboard to avoid floor damage. Always pull the refrigerator straight out when moving it. Do not wiggle or "walk" the refrigerator when trying to move it as you could damage the floor.

Location

- Choose a place that is near a grounded electrical outlet. Do Not use an extension cord or an adapter plug.
- If possible, place the refrigerator out of direct sunlight and away from the range, dishwasher or other heat sources.
- The refrigerator must be installed on a floor that is level and strong enough to support a fully loaded refrigerator.
- Consider water supply availability for

models equipped with an automatic ice maker. If you do not hook up water to the refrigerator, remember to turn the ice maker off.



WARNING

This appliance is intended for use in residential household and similar interior applications such as:

- Kitchen / Kitchenette
- Pantry Room
- Basement
- Enclosed Garage
- Other interior residential type environments



CAUTION

Do not install the refrigerator where the temperature will drop below 55°F (12.8°C) or rise above 110°F (43°C). The compressor will not be able to maintain proper temperatures inside the refrigerator.

Do not block the toe grille on the lower front of your refrigerator. Sufficient air circulation is essential for the proper operation of your refrigerator.



CAUTION

Do not block the lower front of your refrigerator. Sufficient air circulation is essential for the proper operation of your refrigerator.



WARNING

Installation clearances

- Allow the following clearances for ease of installation, proper air circulation, and plumbing and electrical connections:

| | |
|-------------|------|
| Sides & Top | 3/8" |
| Back | 2" |

**NOTE**

If your refrigerator is placed with the door hinge side against a wall, you may have to allow additional space for the handle so the door can be opened wider.

Guidelines for final positioning of your refrigerator:

- All 4 corners of the cabinet must rest firmly on the floor.
- The cabinet should be level at the front and rear.
- The sides should tilt $\frac{1}{4}$ " (6 mm) from front to back (to ensure that doors close and seal properly).
- Doors should align with each other and be level.

To level the cabinet using the front leveling feet:

- Lower the leveling feet on each side clockwise until they contact the floor.

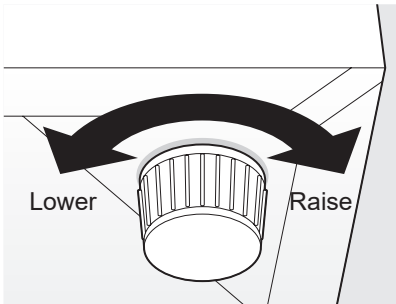

- Use the leveling feet (located on the front) ensure that all 4 corners of the unit are resting firmly on a solid floor. Turn the leveling feet clockwise to retract the feet and counterclockwise to extend the feet. Ensure the floor is strong enough to support a fully loaded unit.

8

DOOR REMOVAL

Tools Necessary:



Phillips™ Head

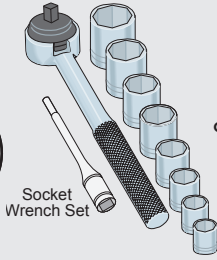
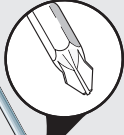

Socket Wrench Set

or

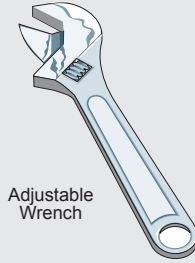

Adjustable Wrench

and

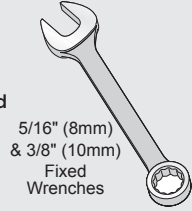

5/16" (8mm)
& 3/8" (10mm)
Fixed Wrenches



NOTE

The direction in which your refrigerator doors open (door swing) can be reversed, from left to right or right to left, by moving the door hinges from one side to the other. Reversing the door swing should be performed by a qualified person.



IMPORTANT

Before you begin, remove the electrical power cord from the wall outlet. Remove any food from door shelves.

Door removal

If the appliance is placed on its back or side during this process it must be allowed to stand upright for 6 hours before plugging in to avoid damage to internal components.

1. Remove the screw hole cover from the top left side of the cabinet. Remove the upper hinge cover and the upper hinge from the top right side of the cabinet. Remove the freezer door from the cabinet.

2. Remove the center hinge from the cabinet. Remove the refrigerator door from the cabinet.

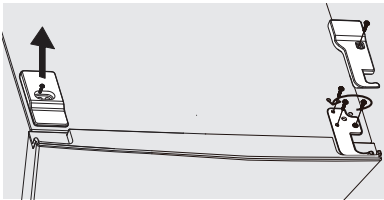
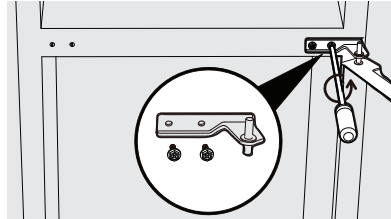

3. Move the hinge hole sleeve from the top right side of the refrigerator door to the top left side of the refrigerator door. Move the hinge hole cover from the top left side of the refrigerator door to the top right side of the refrigerator door.

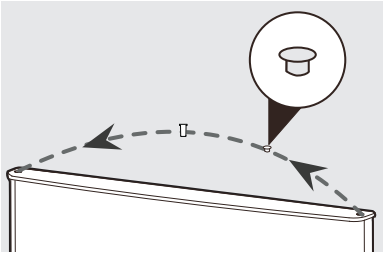

4. Move the screw hole covers from the center left side of the cabinet to the center right side of the cabinet.

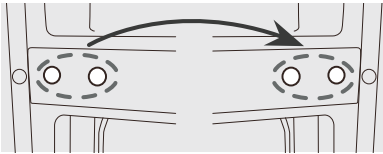

5. Remove both adjustable feet from the bottom of the cabinet. Remove the lower hinge from the bottom right side of the cabinet.

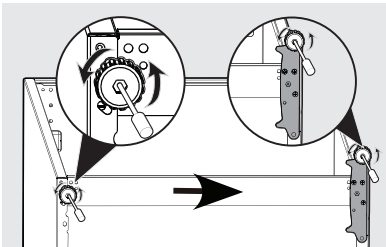

6. Move the screw hole covers from the bottom left side of the cabinet to the bottom right side of the cabinet.



7. Remove the hinge pin from the lower hinge. Flip the lower hinge over. Reinstall the hinge pin on the opposite side of the hinge.

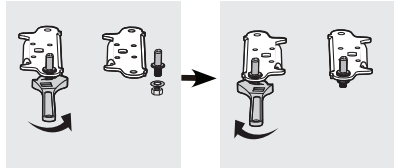

8. Install the lower hinge on the lower left side of the cabinet. Install both the adjustment feet on the bottom of the cabinet

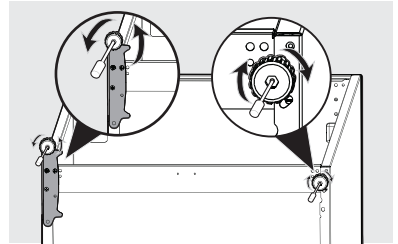

9. Unscrew right middle stopper with metal block from bottom of upper door. The left middle stopper and metal block is in the accessory bag. Install it in left side of bottom of upper door. (The same operation as for lower door.)

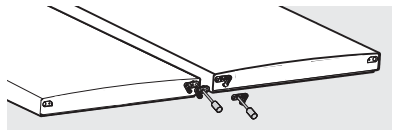

10 DOOR REMOVAL

10. Install the refrigerator door on the cabinet. Flip the center hinge and install it on the center left side of the cabinet.

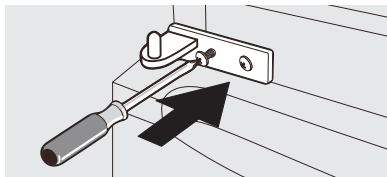

11. Install the freezer door on the cabinet. The upper hinge and the upper hinge cover is in the accessory bag. Install it on the top left side of the cabinet. Install the screw hole cover on the top right side of the cabinet.

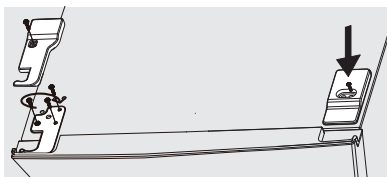

Ice Maker Models Only



NOTE

Automatic ice makers are optional accessories that you may install in most models at any time. Visit www.frigidaire.com for information about Ice Maker Kit IMKTTM0018.



WARNING

To avoid electric shock, which can cause death or severe personal injury, disconnect the refrigerator from electrical power before connecting a water supply line to the refrigerator.



CAUTION

To Avoid Property Damage:

- Use stainless steel braided tubing for the water supply line. Do not use water supply tubing made of ¼ in. plastic. Plastic tubing greatly increases the potential for water leaks, and the manufacturer will not be responsible for any damage if you use plastic tubing for the supply line.
- DO NOT install water supply tubing in areas where temperatures fall below freezing.
- Chemicals from a malfunctioning softener can damage the ice maker. If the ice maker is connected to soft water, ensure that the softener is maintained and working properly.



IMPORTANT

Ensure that your water supply line connections comply with all local plumbing codes.

Before Installing The Water Supply Line, You Will Need:

- Basic Tools: adjustable wrench, flat-blade screwdriver, and Phillips screwdriver
- Access to a household cold water line with water pressure between 30 and 100 psi.
- A water supply line made of stainless steel tubing. To determine the length of tubing needed, measure the distance from the ice maker inlet valve at the back of the refrigerator to your cold water pipe, so the refrigerator can be moved out for cleaning.
- A shutoff valve to connect the water supply line to your household water system. DO NOT use a self-piercing type shutoff valve.
- Do not reuse compression fitting or use thread seal tape.



NOTE

Check with your local building authority for recommendations on water lines and associated materials prior to installing your new refrigerator. Depending on your local/state building codes, Frigidaire recommends for homes with existing valves its **Smart Choice**® water line kit 5304437642 (with a 6 ft. Stainless Steel Water Line) and for homes without an existing valve, Frigidaire recommends its **Smart Choice**® water line kit 5304493869 (with a 6' Polyline Waterline). Please refer to Frigidaire.com for more information.

12

WATER SUPPLY CONNECTION

To Connect the Water Supply Line To the Ice Maker Inlet Valve

1. Disconnect the refrigerator from the electrical power source.
2. Place the end of water supply line into a sink or bucket. Turn ON the water supply and flush the supply line until the water is clear. Turn OFF the water supply at the shutoff valve.
3. Remove the plastic cap from the water valve inlet and discard the cap.
4. **If you use copper tubing**, slide brass compression nut, and then the ferrule (sleeve) onto the water supply line. Push the water supply line into the water valve inlet as far as it will go ($1/4"$ / 6.4 mm). Slide the ferrule (sleeve) into valve inlet and finger tighten the compression nut onto the valve. Tighten another $1/2$ turn with a wrench; DO NOT overtighten. See below.

If you use braided flexible stainless steel tubing, the nut is already assembled on the tubing. Slide the nut onto the valve inlet and finger tighten the nut onto valve. Tighten another $1/2$ turn with a wrench; DO NOT overtighten. See below.

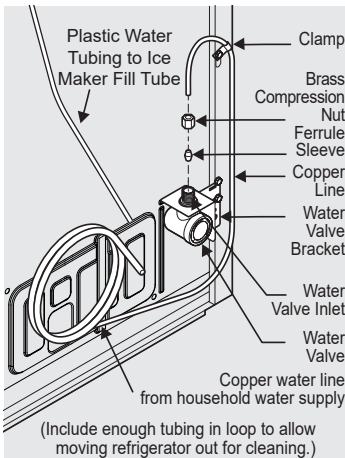

Units with copper tubing

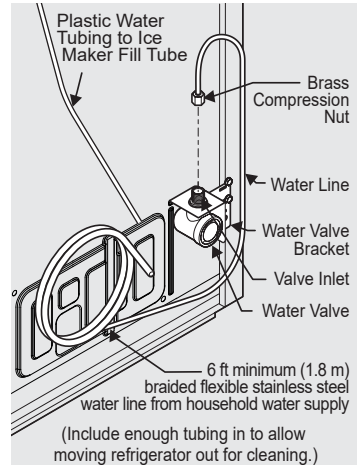

Units with braided flexible stainless steel tubing

5. With the steel clamp and screw, secure the water supply line (copper tubing only) to the rear panel of refrigerator as shown.
6. Coil the excess water supply line (copper tubing only), about $2\frac{1}{2}$ turns, behind the refrigerator as shown and arrange the coils so they do not vibrate or wear against any other surface.
7. To turn the ice maker on, press the ice maker's On/Off power switch so the LED is illuminated.

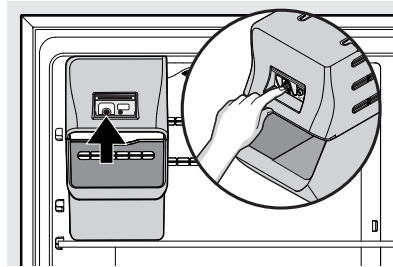

8. Turn ON the water supply at the shutoff valve and tighten any connections that leak.
9. Reconnect the refrigerator to the electrical power source.

**NOTE**

Automatic ice makers are optional accessories that you may install in most models at any time. Visit www.frigidaire.com for information about Ice Maker Kit IMKTTM0018.

If your refrigerator has an automatic ice maker, it will produce minimal ice during the first 24 hours of operation. Air in new plumbing lines may cause the ice maker to cycle 2 or 3 times before making a full tray of ice. With no usage, it will take approximately 1 to 2 days to fill the ice container.

New plumbing connections may cause the first production of ice cubes to be discolored or have an odd flavor. Discard ice made during the first 24 hours.

**IMPORTANT**

The ice maker is shipped in the **On** position. To ensure proper function for your ice maker, hook up the water supply immediately or turn the ice maker **Off**. If the ice maker is on and the water supply is not connected, the water valve will make a loud chattering noise.

Turning your Ice Maker On

After completely connecting the plumbing, you must open the water supply valve. Place the ice container under the ice maker, pushing it as far back as possible. Press the ice maker's On/Off  button.

Turning your Ice Maker Off

To stop the ice maker, press the ice maker's On/Off  button. The ice maker regulates the ice production and stops making ice when full and starts again when ice is low in the ice container.

ICE PRODUCTION: WHAT TO EXPECT

The ice maker will produce 2 to 2.5 pounds of ice every 24 hours depending on usage conditions. Ice is produced at a rate of 10 cubes every 100 to 160 minutes.

**NOTE**

Set the freezer to a colder setting to increase the output of the ice maker. Allow 24 hours for the temperature to stabilize.

**CAUTION**

Do Not place the ice container in your dishwasher.

14 CONTROLS AND SETTINGS

Freezer Temperature Adjustment Refrigerator Temperature Adjustment

The freezer control can be left at the factory pre-set (Recommended) or adjusted as desired.

- Adjust temperature gradually: adjust the knob in small increments, allowing the temperature to stabilize.
- For colder temperatures, adjust the knob towards **Coldest**.
- For warmer temperatures, adjust the knob towards **Cold**.

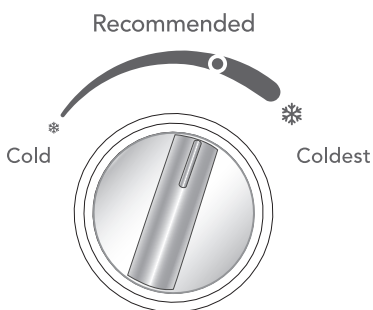

The refrigerator control can be left at the factory pre-set (RECOMMENDED) or adjusted as desired.

- Adjust temperature gradually allowing the temperature to stabilize.
- For colder temperatures, use the **Temp** key and choose **Coldest**.
- For warmer temperatures, use the **Temp** key and choose **Cold**.

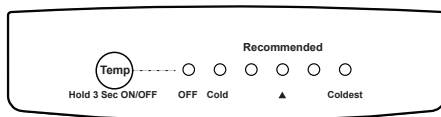

Temp

Push the **Temp** key to change between **Cold**, **Recommended** and **Coldest** temperatures.

Cold, Recommended, Coldest

Indicates the setting of the refrigerator compartment by LED indicator lights.

OFF

To turn the power off, press and hold the **Temp** key for 3 seconds. The **OFF** indicator light will be on.

To turn the power on, press and hold the **Temp** key for 3 seconds. The power will turn on and the power indicator light on the control panel will turn off.

Door Storage

Door bins, shelves, and racks conveniently store jars, bottles, and cans. You can quickly select frequently used items.

Door Bin

Door bins can accommodate gallon-sized plastic drink containers and economy-sized jars and containers.

To remove the door bin:

1. Lift up on the bin
2. Pull it straight out.

To install the door bin:

1. Push the bin back and down into the locking tabs.
2. The bin sides will lock into the tabs.

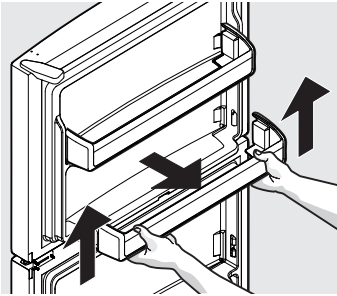

Door Bin

Shelf Adjustment

The shelves are easy to adjust to suit individual needs. Before adjusting the shelves, remove all food.

To adjust shelves, slide the shelf by moving it forward and lifting it upward.

To replace shelves, insert the rear of the shelf into any pair of shelf rails and carefully push the shelf back into position, making sure the shelf clips (A) go in the notch in the liner.

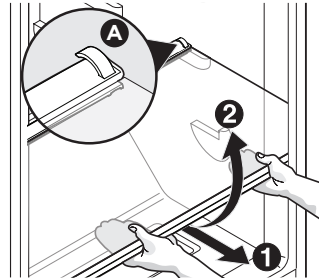

Glass Shelf

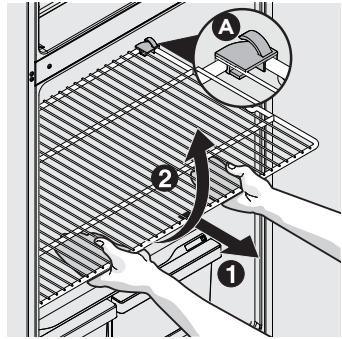

Wire Shelf



CAUTION

When reinstalling the shelf, ensure the shelf clip is attached to the liner and holds it in place.



CAUTION

Do not clean glass shelves or covers with warm water when they are cold. Shelves and covers may break if exposed to sudden temperature changes or impact, such as bumping. Tempered glass is designed to shatter into many small, pebble-size pieces. This is normal. Glass shelves and covers are heavy. Use both hands when removing them to avoid dropping.



CAUTION

To avoid personal injury or property damage, handle tempered glass shelves carefully. Shelves may break suddenly if nicked, scratched, or exposed to sudden temperature change.

16 STORAGE FEATURES

Crisper Humidity Control (some models)

The crisper humidity control, present on the crisper drawers of some models, allows you to adjust the humidity within the crisper. This can extend the life of fresh vegetables that keep best in high humidity.

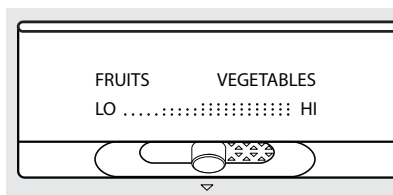

NOTE

Leafy vegetables keep best when stored with the Humidity Control set on High Humidity, or in a drawer without a Humidity Control. This keeps incoming air to a minimum and maintains maximum moisture content. Store non-leafy vegetables and fruits still in their skins at the low humidity setting.

Protecting your investment

Keeping your refrigerator clean maintains appearance and prevents odor build-up. Wipe up any spills immediately and clean the freezer and refrigerator compartments at least twice a year. When cleaning, take the following precautions:

- Never use CHLORIDE or cleaners with bleach to clean stainless steel.
- Do not wash any removable parts in a dishwasher.
- Always unplug the electrical power cord from the wall outlet before cleaning.
- Remove adhesive labels by hand. Do not use razor blades or other sharp instruments which can scratch the appliance surface.
- Do not remove the serial plate.

Do not use abrasive cleaners such as window sprays, scouring cleansers, brushes, flammable fluids, cleaning waxes, concentrated detergents, bleaches or cleansers containing petroleum products on plastic parts, interior doors, gaskets or cabinet liners. Do not use paper towels, metallic scouring pads, or other abrasive cleaning materials or strong alkaline solutions.



NOTE

If you set your temperature controls to turn off cooling, power to lights and other electrical components will continue until you unplug the power cord from the wall outlet.



CAUTION

Pull the refrigerator straight out to move it. Shifting it from side to side may damage flooring. Be careful not to move the refrigerator beyond the plumbing connections.



IMPORTANT

If you store or move your refrigerator in freezing temperatures, be sure to completely drain the water supply system. Failure to do so could result in water leaks when the refrigerator is put back into service. Contact a service representative to perform this operation.

Care and Cleaning Tips

| Part | What To Use | Tips and Precautions |
|---|---|---|
| Interior & Door Liners | <ul style="list-style-type: none"> • Soap and water • Baking soda and water | Use 2 tbsp of baking soda in 1 qt of warm water. Be sure to wring excess water out of sponge or cloth before cleaning around controls, light bulb or any electrical part. |
| Door Gaskets | <ul style="list-style-type: none"> • Soap and water | Wipe gaskets with a clean soft cloth. |
| Drawers & Bins | <ul style="list-style-type: none"> • Soap and water | Use a soft cloth to clean drawer runners and tracks. |
| Glass Shelves | <ul style="list-style-type: none"> • Soap and water • Glass cleaner • Mild liquid sprays | Allow glass to warm to room temperature before immersing in warm water. |
| Exterior & Handles | <ul style="list-style-type: none"> • Soap and water • Non Abrasive Glass Cleaner | Do not use commercial household cleaners containing ammonia, bleach or alcohol to clean handles. Use a soft cloth to clean smooth handles. DO NOT use a dry cloth to clean smooth doors. |
| Exterior & Handles (Stainless Steel Models Only) | <ul style="list-style-type: none"> • Soap and water • Stainless Steel Cleaners | <p>Never use CHLORIDE or cleaners with bleach to clean stainless steel.</p> <p>Clean stainless steel front and handles with non-abrasive soapy water and a dishcloth. Rinse with clean water and a soft cloth. Use a non-abrasive stainless steel cleaner. These cleaners can be purchased at most home improvement or major department stores. Always follow manufacturer's instructions. Do not use household cleaners containing ammonia or bleach.</p> <p>NOTE: Always clean, wipe and dry with the grain to prevent scratching. Wash the rest of the cabinet with warm water and mild liquid detergent. Rinse well, and wipe dry with a clean soft cloth.</p> |
| Replacing Light Bulbs | <ul style="list-style-type: none"> • Unplug appliance • Wear gloves • Remove light cover • Replace old bulb • Replace light cover • Plug in the appliance | <p>CAUTION: Wear gloves when replacing the AC LED light bulbs to avoid getting cut. Use same wattage when replacing bulb.</p> <p>CAUTION: Use only a 5-watt or less AC LED light bulb.</p> |

Let us help you troubleshoot your concern! This section will help you with common issues. If you need us, visit our website, chat with an agent, or call us. We may be able to help you avoid a service visit. If you do need service, we can get that started for you!

1-800-374-4432 (United States)

Frigidaire.com

1-800-265-8352 (Canada)

Frigidaire.ca

Common Occurrences

| | |
|---|--|
| Refrigerator does not run. | <ul style="list-style-type: none"> • Ensure the plug is tightly pushed into an electrical outlet. • Check/replace the fuse with a 15-amp time-delay fuse. Reset the circuit breaker. • The refrigerator control is turned to OFF. • Refrigerator may be in defrost cycle. Wait 20 minutes and check again. |
| Freezer temperature is colder than preferred. Refrigerator temperature is satisfactory. | <ul style="list-style-type: none"> • Set the auxiliary freezer control to a warmer setting until the freezer temperature is satisfactory. Allow 24 hours for the temperature to stabilize. |
| Refrigerator temperature is too cold. Freezer temperature is satisfactory. | <ul style="list-style-type: none"> • Set the refrigerator control to a warmer setting. Allow 24 hours for the temperature to stabilize. Then check the freezer temperature and adjust as needed. |
| Freezer temperature is warmer than preferred. Refrigerator temperature is satisfactory. | <ul style="list-style-type: none"> • Set the auxiliary freezer control to a colder setting until the freezer temperature is satisfactory. Allow 24 hours for the temperature to stabilize. |
| Refrigerator temperature is too warm. Freezer temperature is satisfactory. | <ul style="list-style-type: none"> • Set the refrigerator control to a colder setting. Allow 24 hours for temperature to stabilize. Then check refrigerator temperature and adjust as needed. |
| Refrigerator is noisy or vibrates. | <ul style="list-style-type: none"> • The cabinet is not level. • Floor is weak. • See the NORMAL OPERATING SOUNDS section. |
| Odors in the refrigerator. | <ul style="list-style-type: none"> • The interior needs to be cleaned. • Foods that produce odors should be covered or wrapped. |
| Cabinet light is not working. | <ul style="list-style-type: none"> • Replace with only a 5-watt or less AC LED light bulb. • Ensure the plug is tightly pushed into an electrical outlet. • The light switch may be stuck. Push in the light switch, located on the refrigerator side wall, to release. |
| Automatic ice maker is not working (some models) | <ul style="list-style-type: none"> • Ensure the ice maker is on (green light). • The ice maker should produce 2 to 2.5 pounds of ice in a 24 hour period. • Ensure the water supply is turned on. • The water pressure may be too low. • The freezer may not be cold enough. |
| Ice Maker is not making enough ice (some models) | <ul style="list-style-type: none"> • Set the freezer control to a colder setting to improve the performance of the ice maker. Allow 24 hours for the temperature to stabilize. |

20

LIMITED WARRANTY

Your appliance is covered by a one year limited warranty. For one year from your original date of purchase, Electrolux will pay all costs for repairing or replacing any parts of this appliance that prove to be defective in materials or workmanship when such appliance is installed, used and maintained in accordance with the provided instructions.

Exclusions

This warranty does not cover the following:

1. Products with original serial numbers that have been removed, altered or cannot be readily determined.
2. Product that has been transferred from its original owner to another party or removed outside the USA or Canada.
3. Rust on the interior or exterior of the unit.
4. Products purchased "as-is" are not covered by this warranty.
5. Food loss due to any refrigerator or freezer failures.
6. Products used in a commercial setting.
7. Service calls which do not involve malfunction or defects in materials or workmanship, or for appliances not in ordinary household use or used other than in accordance with the provided instructions.
8. Service calls to correct the installation of your appliance or to instruct you how to use your appliance.
9. Expenses for making the appliance accessible for servicing, such as removal of trim, cupboards, shelves, etc., which are not a part of the appliance when it is shipped from the factory.
10. Service calls to repair or replace appliance light bulbs, air filters, water filters, other consumables, or knobs, handles, or other cosmetic parts.
11. Surcharges including, but not limited to, any after hour, weekend, or holiday service calls, tolls, ferry trip charges, or mileage expense for service calls to remote areas, including the state of Alaska.
12. Damages to the finish of appliance or home incurred during installation, including but not limited to floors, cabinets, walls, etc.
13. Damages caused by: services performed by unauthorized service companies; use of parts other than genuine Electrolux parts or parts obtained from persons other than authorized service companies; or external causes such as abuse, misuse, inadequate power supply, accidents, fires, or acts of God.

DISCLAIMER OF IMPLIED WARRANTIES; LIMITATION OF REMEDIES

CUSTOMER'S SOLE AND EXCLUSIVE REMEDY UNDER THIS LIMITED WARRANTY SHALL BE PRODUCT REPAIR OR REPLACEMENT AS PROVIDED HEREIN. CLAIMS BASED ON IMPLIED WARRANTIES, INCLUDING WARRANTIES OF MERCHANTABILITY OR FITNESS FOR A PARTICULAR PURPOSE, ARE LIMITED TO ONE YEAR OR THE SHORTEST PERIOD ALLOWED BY LAW, BUT NOT LESS THAN ONE YEAR. ELECTROLUX SHALL NOT BE LIABLE FOR CONSEQUENTIAL OR INCIDENTAL DAMAGES SUCH AS PROPERTY DAMAGE AND INCIDENTAL EXPENSES RESULTING FROM ANY BREACH OF THIS WRITTEN LIMITED WARRANTY OR ANY IMPLIED WARRANTY. SOME STATES AND PROVINCES DO NOT ALLOW THE EXCLUSION OR LIMITATION OF INCIDENTAL OR CONSEQUENTIAL DAMAGES, OR LIMITATIONS ON THE DURATION OF IMPLIED WARRANTIES, SO THESE LIMITATIONS OR EXCLUSIONS MAY NOT APPLY TO YOU. THIS WRITTEN WARRANTY GIVES YOU SPECIFIC LEGAL RIGHTS. YOU MAY ALSO HAVE OTHER RIGHTS THAT VARY FROM STATE TO STATE.

If You Need Service

Keep your receipt, delivery slip, or some other appropriate payment record to establish the warranty period should service be required. If service is performed, it is in your best interest to obtain and keep all receipts. Service under this warranty must be obtained by contacting Electrolux at the addresses or phone numbers below.

This warranty only applies in the USA and Canada. In the USA, your appliance is warranted by Electrolux Major Appliances North America, a division of Electrolux Home Products, Inc. In Canada, your appliance is warranted by Electrolux Canada Corp. Electrolux authorizes no person to change or add to any obligations under this warranty. Obligations for service and parts under this warranty must be performed by Electrolux or an authorized service company. Product features or specifications as described or illustrated are subject to change without notice.

USA
1-800-374-4432
Frigidaire
10200 David Taylor Drive
Charlotte, NC 28262



Electrolux

Canada
1.800.265.8352
Electrolux Canada Corp.
5855 Terry Fox Way
Mississauga, Ontario, Canada
L5V 3E4

FRIGIDAIRE®

welcome *home*

Our home is your home. Visit us if you need help with any of these things:



owner support



accessories



service



registration

(See your registration card for more information.)

Frigidaire.com
1-800-374-4432

Frigidaire.ca
1-800-265-8352