

# IZONA CoolDrawer™

**User guide** (EN)

**Guía de usuario** (SP)

**Guide de l'utilisateur** (FR)

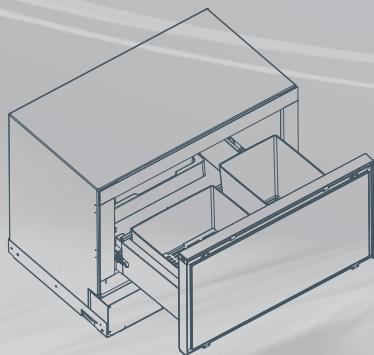

RB36S, RB90S

US CA NZ AU UK IE

## **⚠ WARNING!**



### **Electric Shock Hazard**

Read and follow the **IMPORTANT SAFETY INSTRUCTIONS** outlined in this User Guide before operating this appliance, pages 3 – 4.

Failure to do so can result in death, electric shock, fire or injury to persons.

English

Page 1 – 53

Español

Pág 54 – 107

Français

Page 108 – 161



As an ENERGY STAR® Partner Fisher & Paykel Limited has determined that this product meets ENERGY STAR® guidelines for energy efficiency.

<b>Introduction</b>	<b>2</b>
<b>Important safety instructions</b>	<b>3</b>
<b>Before you start</b>	<b>5</b>
<b>Getting started quickly</b>	<b>6</b>
<b>Customizing the storage environment</b>	<b>8</b>
Freezer mode	9
Additional Freezer mode functions	10
Chill mode	12
Fridge mode	13
Pantry mode	15
Wine mode	17
<b>Which storage mode should I use?</b>	<b>19</b>
<b>General operating instructions</b>	<b>25</b>
Temperature adjustment	25
Key Lock	26
Sabbath mode	26
Fault alarm	27
Control panel beeps	27
Customizable storage containers	28
Normal operating sounds	29
<b>Food storage tips</b>	<b>30</b>
Why food spoils	31
Keeping food fresh	32
Fruit and vegetable care	35
Frozen food care	38
Keeping food safe	41
<b>Caring for your appliance</b>	<b>43</b>
Cleaning	43
<b>Before you call for service</b>	<b>44</b>
<b>Manufacturer's warranty (NZ, AU, UK, IE)</b>	<b>49</b>
<b>Limited warranty (USA, CA)</b>	<b>50</b>
<b>How to get service</b>	<b>53</b>

## ***Important!*** **SAVE THESE INSTRUCTIONS**

The models shown in this User Guide may not be available in all markets and are subject to change at any time. For current details about model and specification availability in your country, please go to our website [www.fisherpaykel.com](http://www.fisherpaykel.com) or contact your local Fisher & Paykel dealer.

## 2 Introduction

Thank you for buying a Fisher & Paykel *CoolDrawer™* food care system.

At Fisher & Paykel we aim to provide innovative products that are simple to use, ergonomic and kind to the environment.

Thousands of hours of food care research and over 75 years of refrigeration experience has been programed into your appliance, to provide you with the best possible performance.

Your appliance will be unlike any refrigeration system you have previously owned, offering you a new level of flexibility, ergonomics and performance.

Your appliance provides you with the ability to customize its storage environment to suit your changing needs. It can be a refrigerator one day, and a freezer or wine cellar the next.

You can also create temperature controlled storage zones where you need them; under the counter of the kitchen, in the living room, or even in the den. The choice is yours.

It is important that you take the time to read these instructions carefully to ensure that you have all the information that you need. This will allow you to take full advantage of the unique food care features this system has to offer you and to receive the best possible food preservation performance.

We hope you enjoy your new food care system, we have certainly enjoyed designing it for you.

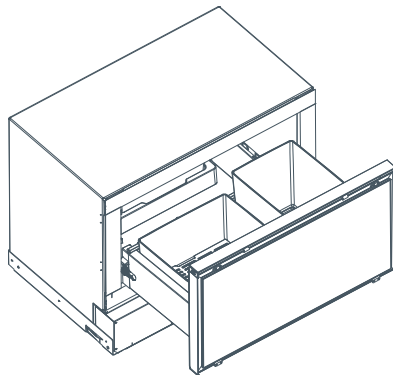

### ***Important!***

*It is important that this User Guide should be retained with your appliance for future reference. Should the appliance be sold or transferred to another owner, please ensure that the User Guide is left with the appliance. This will ensure that the new owner can familiarize themselves with the information and warnings contained within the Guide.*

## ⚠ **WARNING!**



### **Electric Shock Hazard**

Follow the **IMPORTANT SAFETY INSTRUCTIONS** outlined in this User Guide, before operating this appliance.

Failure to do so can result in death, electric shock, fire or injury to persons.

To reduce the risk of fire, electric shock, or injury to persons read the **IMPORTANT SAFETY INSTRUCTIONS** before operating this appliance.

Use this appliance only for its intended purpose as described in this User Guide.

#### **READ ALL INSTRUCTIONS CAREFULLY BEFORE USING THE APPLIANCE**

*When using this appliance always exercise basic safety precautions including the following:*

#### **Danger**

- *This appliance is not intended for use by young children or infirm persons without supervision. Young children should be supervised to ensure they do not play with the appliance.*
- *Risk of child entrapment. Before you throw away your old refrigerator or freezer:*
  - *Take off the doors*
  - *Leave the shelves in place so that children may not easily climb inside.*

#### **Disposal**

- *Extreme care must be taken when disposing of your old appliance to avoid hazards. The refrigerant gas must be safely removed and for the safety of young children, remove doors.*
- *Your Fisher & Paykel Appliances Authorized Service Center will be able to give advice on environmentally friendly methods of disposing of your old refrigerator or freezer.*

#### **Electrical**

- *This appliance must be properly installed in accordance with the installation instructions before it is used.*
- *Never unplug your appliance by pulling on the power cord.*
- *Always grip the plug firmly and pull straight out from the outlet.*
- *Do not plug in any other appliance at its power point or use extension cords or double adapters.*
- *Repair or replace immediately all electric service cords that have become frayed or otherwise damaged. Do not use a cord that shows cracks or abrasion along its length or at either the plug or appliance end.*
- *If the power supply cord is damaged, contact your Fisher & Paykel Appliances Authorized Service Center to purchase a replacement spare part.*
- *Care should be taken when the appliance is installed or removed, to reduce the likelihood of damage to the power supply cord.*
- *Disconnect power to appliance before cleaning.*

## Important safety instructions

### Storing food and drinks

- Never store volatile/flammable materials or solvents in your appliance as they may explode or adversely react with materials in this appliance.
- Never freeze liquids in glass containers. Liquid expands during freezing, which may cause the container to explode.
- Never freeze carbonated drinks. They may explode.
- Do not consume food if it is too cold. Frozen food may be cold enough to cause damage when brought into contact with bare skin, eg. frozen ice cubes.

### Power failure – food safety

- Do not refreeze frozen foods that have thawed completely. Follow the recommendations below if you discover food in your freezer has thawed:
  - 1) Ice crystals still visible – food may be refrozen but should be stored for a shorter period than recommended.
  - 2) Thawed but refrigerator cold – refreezing generally not recommended. Fruits and some cooked food can be refrozen but use as soon as possible. Meat, fish, poultry – use immediately or cook then refreeze. Vegetables – discard as they usually go limp and soggy.
  - 3) Thawed but warmer than 40°F (4°C). Red meat can be cooked immediately and refrozen but use as soon as possible. Discard all other frozen foods.
- Do not refreeze frozen foods that have thawed completely. The food may be dangerous to eat.

### Cleaning

- Many commercially available cleaning products contain solvents which may attack plastic components of your appliance and cause them to crack. Please refer to the cleaning care section of this guide for further advice.
- Always keep the floor around the toe-kick area clean, to limit the amount of dirt or dust that may enter the condenser cooling circuit of the product.

***SAVE THESE INSTRUCTIONS***

## Before placing food in the compartment

- Ideally, allow the compartment to run empty overnight, or for at least 5 hours, to allow it to cool to the appropriate temperature before placing food inside.
- Clean the inside of the appliance with warm water and a little liquid detergent to remove manufacturing and transportation dust.
- The appliance may have an odor initially, but this will go when the compartment has cooled sufficiently.

## Energy efficiency

- Do not leave the drawer open for any longer than is necessary.
- For better energy performance, do not overfill the product as this may restrict cold air distribution in some areas.
- Regularly clean and check the drawer seal (gasket) to ensure a good seal.

If your appliance is turned off for any reason, wait 10 minutes before turning it back on. This will allow the refrigeration system pressures to equalize before restarting.

The compartment temperature is accurately controlled and does not change with the temperature or humidity of the surroundings; whether summer or winter.

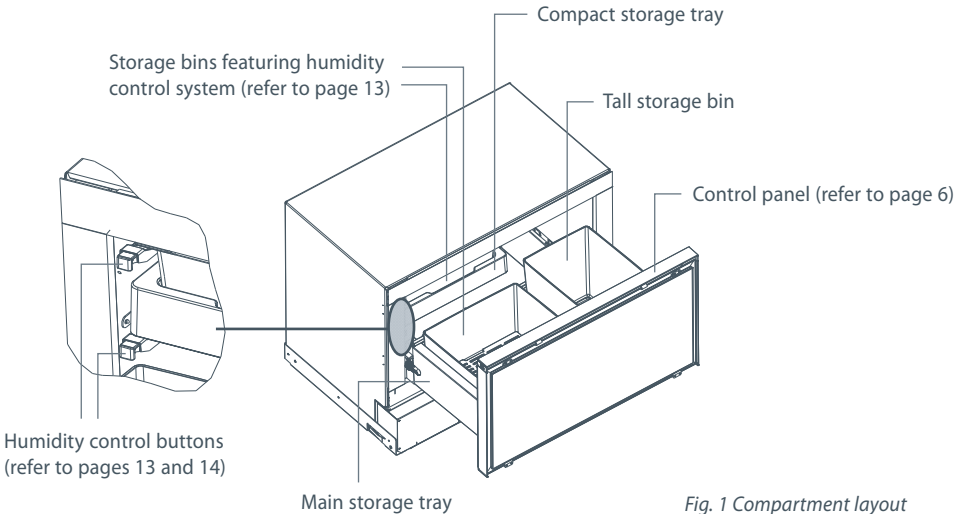

Fig. 1 Compartment layout

## 6 Getting started quickly

### Operating instructions

#### **Important!**

*Before placing food into the cabinet for the first time, it is important that you ideally, allow the cabinet to run empty overnight, or for at least 5 hours, to allow it to cool to the appropriate temperature before placing food inside.*

### Control panel features

- A Sabbath mode, Control panel beeps, Fault alarm
- B Key Lock
- C Temperature adjustment
- D Mode select
- E Storage modes
- F Function select
- G Additional Freezer functions (only active once Freezer mode is selected)

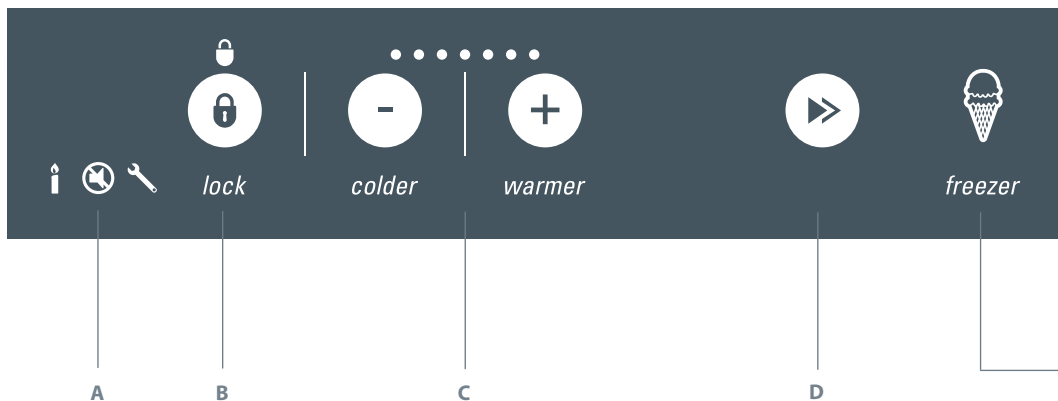



Fig.2 CoolDrawer™ control panel



## ***Important!***

*Your cabinet will default to 'Freezer mode' when you first turn it on. If you do not wish to use the appliance as a freezer, simply select another option from the other four storage modes displayed on the control panel.*

### **To use the control panel**

- 1 Unlock the control panel by pressing and holding the LOCK  button for 3 seconds. A beep will sound and the Key Lock light will go out.
- 2 Simply match the type of items that you wish to store in the compartment to the relevant storage environment (refer to page 8).
- 3 Press the MODE SELECT  button to scroll to the desired mode, which best represents the food items you wish to store.
- 4 The storage mode icon selected will flash until the compartment reaches a suitable temperature for food to be added into the compartment (this will take between 1 – 6 hours approximately).



*chill*



*fridge*



*pantry*



*wine*



- *bottle chill*
- *fast freeze*
- *deep freeze*



**E**

**F**

**G**

## Customizing the storage environment

The CoolDrawer™ has a wide range of operating modes, from a deep freezer, freezer, chiller, fridge, pantry and even a wine cooler.

	To change the storage mode:
	<ol style="list-style-type: none"> <li>1 Press and hold the LOCK  button for 3 seconds to unlock the control panel.</li> <li>2 Press the MODE SELECT  button.</li> <li>3 Scroll to the required storage mode.</li> <li>4 The storage mode icon will flash until the compartment is at a suitable temperature for food to be added into the compartment (this will take between 1 – 6 hours).</li> </ol>

### Storage modes



#### Freezer mode (0°F / -18°C)

For general frozen food storage (refer to page 9).



#### Chill mode (31°F / -0.5°C)

Premium extra-cold storage for highly perishable fresh meat, fish and poultry (refer to page 12).



#### Fridge mode (37°F / 3°C)

General storage for fresh food, dairy and leftovers (refer to page 13).



#### Pantry mode (54°F / 12°C)

Ideal for tropical fruit and temperature sensitive foods that require extra care, eg. bananas, tomatoes. Also perfect for foods recommending storage in a 'cool, dark place' (refer to page 15).







#### Wine mode (45 – 59°F / 7 – 15°C)

Provides ideal long term cellaring for wine, as well as 2 additional customized short term storage environments (refer to page 17).





## Freezer mode

The use of temperatures of 0°F / -18 °C or colder to store food means that the food can be kept for longer periods than when refrigeration temperatures are used. This is because the growth of bacteria, moulds and yeasts are stopped, and chemical and physical reactions are severely restricted at such low temperatures. This results in food staying fresher for longer.

	<b>To use Freezer mode:</b>
	<ol style="list-style-type: none"> <li>1 Press and hold the LOCK  button for 3 seconds to unlock the control panel.</li> <li>2 Press the MODE SELECT  button.</li> <li>3 Scroll to FREEZER  mode.</li> <li>4 The Freezer mode icon will flash until the compartment is at a suitable temperature for food to be added into the compartment (this will take between 1 – 6 hours).</li> </ol>

## Recommended freezer storage times for food stored on freezer mode

These times should not be exceeded.

	M o n t h s	1	Bacon, casseroles, milk
		2	Bread, ice-cream, sausages, pies (meat and fruit), prepared shellfish, oily fish
		3	Non oily fish, shellfish, pizza, cakes and muffins
		4	Ham, beef and lamb chops, poultry pieces
		6	Butter, vegetables (blanched), eggs whole and yolks, cooked crayfish, minced meat (raw), pork (raw)
		12	Fruit (dry or in syrup), egg whites, beef (raw), whole chicken, lamb (raw), fruit cakes

For optimum freezing results we recommend removing storage bins from the compartment and placing packaged food directly on the trays.

## Additional freezer mode functions

Note: Only one Freezer mode function may be operated at any one time.





### Bottle Chill

This function allows you to rapidly chill your beverages in the freezer without the worry of forgetting about them. Activating Bottle Chill drops the freezer down to its coldest setting for a 15 minute time period. After 15 minutes, an alarm will sound to remind you to remove your beverage. The user alarm will continue to sound until the drawer is opened and the display panel is unlocked. The Bottle Chill light will also flash.

Remember to remove your beverage when the alarm sounds, to ensure the liquid does not freeze.

### **Important!**

*This function can only be activated when the compartment is already set to 'Freezer' setting.*

	To use the Bottle Chill function:
	<ol style="list-style-type: none"> <li>1 Press and hold the LOCK  button for 3 seconds to unlock the control panel.</li> <li>2 Press the FUNCTION SELECT  button to select BOTTLE CHILL. The Bottle Chill timer will start automatically.</li> <li>3 Place your beverage into the compartment. To turn Bottle Chill off at any time, press the FUNCTION SELECT  button three times until no Freezer function lights are displayed.</li> </ol>

The Temperature adjustment light will scroll back and forth over the 15 minute period to remind you that Bottle Chill is active.





### Fast Freeze

The Fast Freeze function has been designed to assist in preserving fresh food quality by freezing food at a faster rate than the normal freezer setting. Activating Fast Freeze drops the freezer temperature down to its coldest temperature for a 24 hour time period. You may wish to use this when freezing meat or when you are making frozen desserts. It is also good to use when arriving home from the supermarket and adding fresh food into the freezer.

### **Important!**

*This function can only be activated when the compartment is already set to 'Freezer' setting.*

## Additional freezer mode functions

	<b>To use the Fast Freeze function:</b>
	<ol style="list-style-type: none"> <li>1 Press and hold the LOCK  button for 3 seconds to unlock the control panel.</li> <li>2 Press the FUNCTION SELECT  button to select FAST FREEZE. Fast Freeze will start automatically.</li> <li>3 Place your fresh food to be frozen into the compartment.</li> <li>4 Fast Freeze will automatically switch off after 24 hours and return to Freezer mode. To turn Fast Freeze off at any time, press the FUNCTION SELECT  button twice until no Freezer function lights are displayed.</li> </ol>

The Temperature adjustment light will scroll back and forth over the 24 hour period to remind you that Fast Freeze is active.

For best results, we recommend that you activate this function approximately 2 hours before it is required. Alternatively, activate it when placing food into the freezer.

### Deep Freeze





The key to long term frozen storage is low temperature. The lower the temperature, the longer frozen food will retain vital flavor and quality.

The reduced temperature of Deep Freeze will keep frozen food at its best for longer periods. Deep Freeze sets the compartment at -13°F / -25°C.

Ensure that food is placed in thick freezer proof packaging.

### ***Important!***

*This function can only be activated when the compartment is already set to 'Freezer' mode.*

	<b>To use the Deep Freeze function:</b>
	<ol style="list-style-type: none"> <li>1 Press and hold the LOCK  button for 3 seconds to unlock the control panel.</li> <li>2 Press the FUNCTION SELECT  button to select DEEP FREEZE. To turn Deep Freeze off at any time, press the FUNCTION SELECT  button once until no Freezer function lights are displayed.</li> </ol>

Note:

- Deep Freeze function has no additional temperature adjustment.
- While Deep Freeze is active no lights will be displayed on the temperature adjustment area.

## Chill mode

The Chill mode sets the compartment at a temperature that is ideal for the storage of highly perishable fresh meats, poultry and fish products. It is ideal to hold highly perishable food at a temperature as close to freezing as possible to retain their vital freshness.





This mode sets the compartment at 31°F / -0.5°C, just above the freezing temperature for meat. This reduces the amount of microbial activity and slows physical changes, ensuring that meat stays fresher for longer.

The quality of the perishable food that is placed in Chill mode will be critical to successful storage. Ensure that meat is fresh when purchased and stored.

The Chill mode can also be used for chilling alcoholic beverages.

### ***Important!***

*This setting is not recommended for any other food or non-alcoholic drink items.*

	To use Chill mode:
	<ol style="list-style-type: none"> <li>1 Press and hold the LOCK  button for 3 seconds to unlock the control panel.</li> <li>2 Press the MODE SELECT  button.</li> <li>3 Scroll to CHILL  mode.</li> <li>4 The Chill mode icon will flash until the compartment is at a suitable temperature for food to be added into the compartment (this will take between 1 – 6 hours).</li> </ol>





Research tells us that highly perishable food stored on Chill mode will last 2 – 3 times longer than when stored at normal fridge temperatures.

## Fridge mode

The Fridge mode is the ideal storage environment for most fresh foods.

When storing fresh fruits and vegetables, we recommend that they are stored in either the bin on the top tray or the bin on the left-hand side of the main tray. Both of these bins are humidity controlled. This will help to preserve the quality of the fruits and vegetables, therefore increasing their storage life.

- If possible, separate fruit and vegetables for optimum storage life.
- Ensure all food is well wrapped (except for fruit and vegetables stored in the vegetable bins), covered or placed in a container before it is stored.

	To use Fridge mode:
	<ol style="list-style-type: none"> <li>1 Press and hold the LOCK  button for 3 seconds to unlock the control panel.</li> <li>2 Press the MODE SELECT  button.</li> <li>3 Scroll to FRIDGE  mode.</li> <li>4 The Fridge mode icon will flash until the compartment is at a suitable temperature for food to be added into the compartment (this will take between 1 – 6 hours).</li> </ol>

## Fruit and vegetable Humidity Control System (HCS)

### Humidity control cover

The vegetable bins feature a unique hidden cover which provides two functions:

- The humidity cover seals the bins and provides a humid micro climate to extend storage times of fruits and vegetables.
- The humidity cover prevents condensation, which forms at high humidity, from dripping down onto the fruit and vegetables by retaining the moisture droplets in the lid. The ability to maintain high humidity in the fruit and vegetable bins may produce small amounts of water in the bottom of the fruit and vegetable bins. This can be wiped out as necessary.

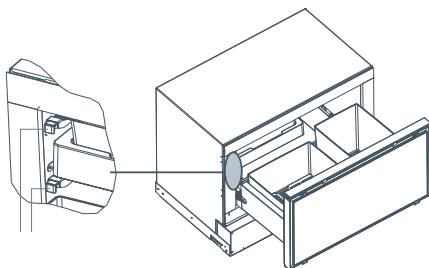



Fig 3. Humidity control buttons

## Humidity control

- Each fruit and vegetable bin has a humidity control button that can be adjusted to care for fruit or vegetables depending on what is stored in the bins. The humidity controls are located on the left hand side of the compartment (as shown in fig 3, on the previous page).
- If possible, try to store fruit and vegetables separately. This will help to extend their storage life.
- If there is too much water in the bins, the control can be adjusted to the FRUIT setting.

Remember a small amount of water in the bins is beneficial for fruit and vegetable storage. The vegetable screens, in the bottom of the bins, will ensure that fresh produce is held above any moisture in the bottom of the bins to retain optimum freshness.

	<b>To adjust the humidity setting:</b>
	The picture on the top of the humidity control button will show the current setting. To change the setting, simply push the adjustment button.



<b>Suitable for:</b>	<b>Suitable for:</b>
Salad greens (high humidity) – Lettuce – Spinach	Fruit with skin/ peel (reduced humidity) – Apples – Pears – Kiwifruit
Broccoli	
Cabbage	
Carrots	

For a more detailed list please refer to pages 22 – 24.



## Pantry mode

The Pantry mode finally provides a solution for all those foods that you didn't previously know what to do with, and have always resorted to storing on the bench or in the cupboard.

The Pantry mode is designed specifically for foods that require a 'cool, dark place' for storage.

### Sensitive food

There are a wide variety of foods that often perish quickly if stored at room temperature but can be damaged by normal refrigerator temperatures, eg. bananas and tomatoes.

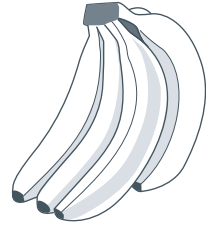





The Pantry mode provides a stable storage environment at 54°F / 12°C, making it an ideal environment for sensitive food items. Pantry mode also allows tropical fruits, eg. avocados, melons and pineapples, to ripen slowly under controlled conditions, without the risk of damage from low temperatures.

### A cool cupboard

Freshly baked items such as cakes and breads can quickly turn mouldy when placed in the cupboard but become hard and stale when placed in a conventional refrigerator. The Pantry mode provides ideal storage for these items so that they remain fresher for longer. It is also a great place to store dried goods, cereals and other items that can become a target for mould and insects when stored at room temperature.

## Important!

*The Pantry mode is not suitable for highly perishable fresh dairy and meat items, or pre-cooked foods.*

	<b>To use Pantry mode:</b>
	<ol style="list-style-type: none"> <li>1 Press and hold the LOCK  button for 3 seconds to unlock the control panel.</li> <li>2 Press the MODE SELECT  button.</li> <li>3 Scroll to PANTRY  mode.</li> <li>4 The Pantry mode icon will flash until the compartment is at a suitable temperature for food to be added into the compartment (this will take between 1 – 6 hours).</li> </ol>

## Customizing the storage environment

The following table shows some examples of food items that are suitable for the Pantry mode.

Fruits	Vegetables	General Foods
Avocado	Basil	Baked goods
Bananas	Courgettes/zucchini	Breads
Feijoas	Cucumbers	Chocolate
Grapefruit	Eggplant/aubergine	Cereals
Guava	Potatoes	Dried goods
Lemons	Pumpkin	Dried Herbs
Limes	Squash	Nuts
Mangos	Taro	
Passionfruit		
Papaya/ Pawpaw		
Pineapple		
Tomatoes		
Watermelons		

### Additional uses for Pantry mode

- Keep your natural cosmetic and skin care products in Pantry mode to keep them fresher for longer.
- When the weather is hot, keep your moisturiser, toner and spritzer cool for a refreshing lift when applied.
- Use Pantry mode to ripen moulded cheeses, eg. brie, camembert, blue cheese. Ensure that cheeses are well wrapped, and once ripened, place back into Fridge mode.
- Keep dry goods out of reach of insects and high humidity in summer months.

## Wine mode

The conditions in which wine is stored can have large effects on its overall taste and aroma. Warmer temperatures can cause premature aging of wines and loss of quality. Cold temperatures can be just as bad, causing irreversible damage to the flavor. Temperature fluctuation can also have a negative impact on wine quality. Typical household fluctuations in temperature from day to night can cause harm to wine over time.

The Wine mode provides an ideal controlled environment for the long and short-term storage of both red and white wines.





### Long-term storage

For long-term storage (longer than one week) of both red and white wines, the ideal recommended storage temperature is 54°F / 12°C. When Wine mode is selected, the compartment is automatically set to this ideal, constant temperature, to provide the optimum conditions for long term storage.

### Short-term storage / serving

Wine mode is also ideal for short-term storage (less than one week) of wines. Both red and white wines require different serving temperatures to ensure an optimum taste experience. White wines should be served at cooler temperatures (approximately 45°F / 7°C) whereas red wines are better served at warmer temperatures (approximately 59°F / 15°C). The Wine mode can be customized to provide these two optimum serving temperatures.

Serving temperature	Wine type
45°F / 7°C	Suitable for the majority of white wines including <b>Chardonnay, Sauvignon Blancs, Rieslings, Chenin Blancs and Pinot Gris</b> . If white wines are served too cold, the aromas and flavors will be minimized and you won't get full enjoyment.
59°F / 15°C	Suitable for red wines including <b>Merlot, Bordeaux, Zinfandel, Cabernet Sauvignon and Syrah/Shiraz</b> . If red wines are served too warm the alcohol can produce an unpleasant bite on the palate.

	To use Wine mode:
	<ol style="list-style-type: none"> <li>1 Press and hold the LOCK  button for 3 seconds to unlock the control panel.</li> <li>2 Press the MODE SELECT  button.</li> <li>3 Scroll to WINE  mode.</li> <li>4 The Wine mode icon will flash until the compartment is at a suitable temperature for wine bottles to be added to the compartment (this will take between 1 – 6 hours).</li> </ol>

## To customize the storage environment for ideal serving temperatures:

Use the Temperature adjustment control to change the temperature.



### Cellar (Default Setting)

Automatically selected when Wine mode is selected.  
Long term wine storage for red and white wine cellaring

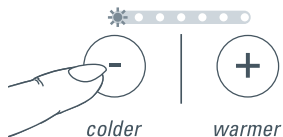

### White wine

For white wine short term storage and serving press the COLDER button to select the white wine (-) setting.









### Red wine

For red wine short term storage and serving press the WARMER button to select the red wine (+) setting.

Fig.4 Adjusting temperature







## Important!

These times are intended as a guide only. If products have a "best-before" or "use-by" date, always refer to this for storage times. Always check food for signs of spoilage before consumption.

	Approximate storage time		Recommended storage mode					
	Frozen (Freezer mode)	Fresh	 deep freeze	 freezer	 chill	 fridge	 pantry	 wine
<b>Meat, fish and poultry</b>								
<b>Meat</b>								
Beef (roasts, steaks)	6 – 12 months	1 week	**	*	✓			
Pork (roasts, steaks)	4 – 8 months	3 – 7 days	**	*	✓			
Lamb (chops, roasts)	8 – 12 months	5 – 12 days	**	*	✓			
Other meat (eg. Kidneys, Liver etc)	3 – 5 months	3 – 5 days						
<b>Ground meat</b>								
Beef hamburger (ground)	3 – 4 months	1 – 2 days	**	*	✓			
Pork, Lamb, Veal, Turkey (ground)	3 – 4 months	1 – 2 days	**	*	✓			
<b>Processed meat products</b>								
Ham (lean)	1 – 2 months	3 – 5 days	**	*	✓			
Bacon	1 month	2 – 3 weeks	**	*	✓			
Sausage (raw)	1 – 2 months	1 – 7 days	**	*	✓			
Sausage (smoked links or patties)	1 – 2 months	1 – 3 weeks	**	*	✓			
<b>Poultry</b>								
Chicken or Turkey (pieces)	4 – 6 months	2 – 5 days	**	*	✓			
Chicken or Turkey (whole)	8 – 12 months	2 – 7 days	**	*	✓			
Goose or Duck	6 months	2 – 5 days	**	*	✓			
<b>Fish and shellfish</b>								
Haddock, Cod, Hake, Tuna	3 – 4 months	2 – 7 days	**	*	✓			
Oily fish (eg. Salmon, Mackerel)	3 – 6 months	3 – 8 days	**	*	✓			
Shellfish (prepared)	6 months	1 – 5 days	**	*	✓			
Lobster, Crayfish (cooked)	2 – 3 days	6 months	**	*	✓			

- \*\* Longer term frozen storage
- \* Shorter term frozen storage
- ✓ Fresh storage

## 20 Which storage mode should I use?

	Approximate storage time		Recommended storage mode					
	Frozen (Freezer mode)	Fresh	 deep freeze	 freezer	 chill	 fridge	 pantry	 wine
<b>Dairy products, cooked foods and deli items</b>								
<b>Dairy products</b>								
Butter	6 months	1 – 3 months	**	*		✓		
Fresh cheeses (eg. ricotta, mozzarella or cottage)	ns	1 – 2 weeks				✓		
Cheese, (eg. cheddar)	ns	3 months				✓		
Grated cheese (airtight)	ns	1 – 2 weeks	**	*		✓		
Moulded cheeses (to ripen)	ns	1 – 4 weeks					✓	
Milk, low fat	1 month	1 – 2 weeks	**	*		✓		
Yogurt	ns	1 month				✓		
Ice Cream	2 – 6 months	ns	**	*				
<b>Eggs</b>								
Fresh eggs (in shell)	6 months	2 – 4 weeks	**	*		✓		
Cooked eggs (hard)	ns	1 week				✓		
<b>Deli items</b>								
Store brought salads (eg. pasta, tuna, chicken, ham, egg)	ns	1 – 3 days				✓		
Lunch meats (thinly sliced)	ns	1 – 3 days				✓		
Pre-prepared convenience meals	ns	1 – 2 days				✓		
<b>Cooked foods and leftovers</b>								
Leftovers – reheat until steaming before consuming	ns	1 – 2 days				✓		
Cooked meat and meat dishes	1 – 2 months	2 – 4 days	**	*		✓		
Pies (meat and fruit)	1 – 2 months	2 – 4 days	**	*		✓		







\*\* Longer term frozen storage

\* Shorter term frozen storage

✓ Fresh storage

ns Not suitable

# Which storage mode should I use? 21

	Approximate storage time		Recommended storage mode					
	Frozen (Freezer mode)*	Fresh	 <i>deep freeze</i>	 <i>freezer</i>	 <i>chill</i>	 <i>fridge</i>	 <i>pantry</i>	 <i>wine</i>
<b>Other</b>								
Bread	2 months	2 – 7 days	**	*			✓	
Baked goods	3 months	2 – 7 days	**	*			✓	
Vegetables (blanched)	6 months	ns	**	*				
Fruit (dry or in syrup)	12 months	ns	**	*				
Oil (salad and cooking)	–	–					✓	
Beverages (general)	–	–				✓		
Alcoholic beverages (to be chilled)	–	–			✓			
Wine	–	–						✓







\*\* Longer term frozen storage

\* Shorter term frozen storage







✓ Fresh storage

ns Not suitable

## 22 Which storage mode should I use?

		Recommended storage mode					
							
		<i>deep freeze</i>	<i>freezer</i>	<i>chill</i>	<i>fridge</i>	<i>pantry</i>	<i>wine</i>
Fresh vegetables	Approximate storage time						
Artichokes	1 – 2 weeks				✓		
Asparagus	2 – 3 weeks				✓		
Avocado	2 – 4 weeks					✓	
Beans (snap, green)	7 – 10 days				✓		
Bean Sprouts	7 – 10 days				✓		
Beets (topped)	Up to 4 months				✓		
Belgian endive	2 – 4 weeks				✓		
Bok Choy	3 weeks				✓		
Broccoli	1 – 2 weeks				✓		
Brussel sprouts	3 – 5 weeks						
Cabbage	1 – 2 months				✓		
Carrots (topped)	1 – 3 months				✓		
Cauliflower	3 – 4 weeks				✓		
Celery	1 – 2 months				✓		
Chard	1 – 2 weeks				✓		
Corn (sweet and baby)	1 week				✓		
Cucumber	1 – 2 weeks					✓	
Daikon	Up to 4 months				✓		
Eggplant (aubergine)	1 – 2 weeks					✓	
Garlic	6 months				✓		
Ginger	6 months					✓	
Herbs	1 – 2 weeks				✓		
Horseradish	10 – 12 months				✓		
Leafy greens, general	1 – 2 weeks				✓		
Leek	1 – 2 months				✓		
Lettuce	2 – 3 weeks				✓		
Mushrooms	1 – 2 weeks				✓		









		Recommended storage mode					
							
		<i>deep freeze</i>	<i>freezer</i>	<i>chill</i>	<i>fridge</i>	<i>pantry</i>	<i>wine</i>
Fresh vegetables	Approximate storage time						
Okra	7 – 10 days					✓	
Onion	Up to 6 months				✓		
Parsnips	1 – 3 months				✓		
Peas (in pods)	1 – 2 weeks				✓		
Peppers	2 – 3 weeks				✓		
Potato	2 – 7 months					✓	
Pumpkin (uncut)	1 – 3 months					✓	
Radicchio	4 – 8 weeks				✓		
Radish	1 – 2 months				✓		
Rhubarb	2 – 4 weeks				✓		
Rutabaga	4 – 6 months				✓		
Shallot	1 – 2 weeks				✓		
Spinach	1 – 2 weeks				✓		
Squash (summer)	1 – 2 weeks					✓	
Sweet potato or yam	2 – 7 months					✓	
Taro	Up to 4 months					✓	
Turnip	2 – 5 months				✓		
Watercress	2 – 3 weeks				✓		

## Recommended humidity setting:



Select VEGETABLE humidity setting for storage bin (refer to page 14).

## 24 Which storage mode should I use?

		Recommended storage mode					
							
		<i>deep freeze</i>	<i>freezer</i>	<i>chill</i>	<i>fridge</i>	<i>pantry</i>	<i>wine</i>
Fresh fruit	Approximate storage time						
Apples	1 – 3 months				✓		
Apricots	1 – 2 weeks				✓		
Bananas	1 – 4 weeks					✓	
Berries	3 – 18 days				✓		
Cherries (sweet)	2 – 4 weeks				✓		
Cranberries	2 – 4 months				✓		
Dates	Up to 6 months				✓		
Feijoa	2 – 3 weeks					✓	
Fig, fresh	7 – 10 days				✓		
Gooseberry	3 – 4 weeks				✓		
Grapes	1 – 4 weeks				✓		
Guavas	2 – 3 weeks					✓	
Lemons	1 – 6 weeks					✓	
Limes	1 – 6 weeks					✓	
Mandarins	1 – 6 weeks					✓	
Mangos	2 – 4 weeks					✓	
Melons	2 – 4 weeks					✓	
Nashi (Asian pear)	1 – 3 months				✓		
Nectarines	2 – 4 weeks				✓		
Oranges	1 – 6 weeks				✓		
Olives, fresh	4 – 6 weeks					✓	
Papayas	1 – 3 weeks					✓	
Passionfruit	3 – 4 weeks					✓	
Peaches	2 – 4 weeks				✓		
Pears	1 – 3 months				✓		
Persimmons	1 – 3 months				✓		
Pineapples	2 – 4 weeks					✓	
Plums and prunes	2 – 5 weeks				✓		
Pomegranates	2 – 3 months				✓		
Tomatoes	1 – 5 weeks					✓	
Watermelon	2 – 3 weeks					✓	
Quince	2 – 3 months				✓		

### Recommended humidity setting:



Select FRUIT humidity setting for storage bin (refer to page 14).

## Temperature adjustment

- Each of the storage modes will automatically default to an ideal temperature setting. This setting provides the recommended temperature for this storage environment. However, if you want to increase or decrease the temperature of the compartment, this can be done using the Temperature adjustment control.

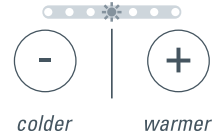

The recommended temperature is always the center light.

## To adjust the temperature

The pre-set temperature for each storage environment will show one illuminated light in the center of the scale

- To **increase** the temperature, simply touch the 'warmer' icon (+). Each light displayed will increase the temperature setting slightly. When all four lights on the right are showing, you have reached the warmest setting.
- To **decrease** the temperature, simply touch the 'colder' icon (-). Each light displayed will decrease the temperature setting slightly. When all four lights on the left are showing, you have reached the coldest setting.

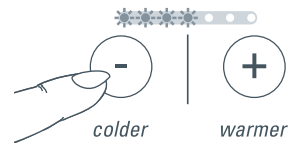
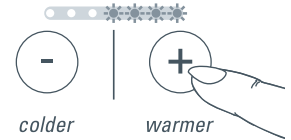







Fig.5 Adjusting temperature

## Key Lock

- The Key Lock mode disables the control panel so that the storage environment cannot accidentally be changed.
- The display will automatically lock after 15 seconds of the display not being used or when the drawer is closed. The red lock icon will appear above the Lock button when the panel is locked.

	<b>To use the Key Lock mode:</b>
	Press the LOCK  button for 3 seconds to lock or unlock the control panel.

## Sabbath mode

	<b>To use the Sabbath mode:</b>
	Press and hold the LOCK  button for 3 seconds to unlock the control panel. To activate and deactivate the Sabbath mode press and hold the LOCK  and MODE SELECT  buttons for 4 seconds until the Sabbath mode icon is displayed.

### When the appliance is in Sabbath mode:

- The light will not operate when the drawer is opened.
- The drawer alarm will not operate.
- The display will not be illuminated.
- Opening the drawer will not affect the compressor or fans.
- If the power to the refrigerator is turned off whilst in this mode, the appliance will continue in Sabbath mode when the power is restored.
- Sabbath mode will automatically de-activate 80 hours after activation.
- To de-activate earlier than 80 hours press and hold the LOCK and MODE SELECT buttons for 4 seconds.

## Fault Alarm



If the electronic controller detects a fault which may affect operation, an alarm will sound and the fault icon on the display panel will flash. The audible alarm will stop when any button is pressed but the lights will continue flashing.

If such a fault occurs, call your Fisher & Paykel Appliances Authorized Service Center immediately; the fault alarm sound will help the service person find and remedy the cause of failure.

### ***Important!***



*Your refrigerator is designed to operate for many years without the need for service checks. However, if your refrigerator is malfunctioning, have it attended to by your Fisher & Paykel Appliances Authorized Service Center as soon as possible. All electrical repairs must be carried out by an adequately trained service technician or qualified electrician.*

## Control panel beeps

The control panel beeps can easily be silenced, if you prefer quiet operation.



### To turn control panel beeps on or off:

Press the LOCK  button for 3 seconds to unlock the control panel.  
Press and hold the LOCK  and COLDER  buttons for 4 seconds until the beep icon turns off or on.

## Drawer alarms

- If the drawer is left open an alarm will sound after 60 seconds.
- If the drawer remains open, subsequent beeps will sound every 30 seconds until the drawer is closed.
- After 5 minutes the alarm will sound continuously and the compartment light will turn off.

## Customizable storage containers

- The *CoolDrawer™* allows you to adjust the storage space, to meet your needs.
- Remove bins to provide open flexible storage space
- Multi-level storage provides segregation of food items. The compact upper storage tray provides safe storage for delicate items or segregation for small items.

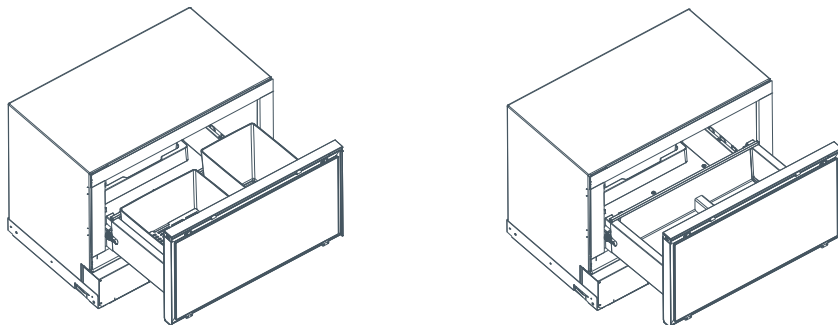

*Fig. 6 Mix and match storage containers to customize the compartment*

## Normal operating sounds

*CoolDrawer™* with its excellent energy ratings and cooling performance, can produce sounds that may be different to your old refrigerator.

### Normal operational sounds include:

- **Fan, airflow sound.** The *CoolDrawer™* has a fan which circulates air around the compartment to provide cooling. This produces some air flow sound. This is quite normal.

The *CoolDrawer™* also has a condenser fan to discharge heat through the condenser. This also produces some airflow sound. This is normal.

- **Cracking or popping** which may sound like ice breaking or falling. This occurs when the defrost function is operating.
- **Running water sound.** This is the liquid refrigerant in the system, and can be heard as a boiling or gurgling noise.
- **An audible hissing sound** after closing the drawer. This is due to the pressure difference between the warm air that has entered the cabinet and suddenly cooled, and the outside air pressure.
- **A humming sound.** This is normal as the motor operates for long periods of time. This appliance uses an energy efficient, variable speed compressor that saves energy by running for long periods of time on a low speed. This is more energy efficient than the conventional on/off method.
- Other sounds may be heard for the following reasons:
  - Floor or cabinetry uneven or weak.
  - Bottles or jars rattling.
  - Appliance not installed correctly.

## Food storage tips

Never before have we had better food available or a wider choice than we have today. We are more aware of quality and we are more aware of health.

We are rediscovering the anti-aging properties of food, their ability to lower cholesterol, increase lifespan, and improve general well being. We pay handsomely for exotic flavors and speciality foods. All these valuable food qualities can be damaged if subjected to temperatures and conditions which are not ideal.

These sensitive, fresh foods need to be treated with care if they are to retain their critical storage life, flavor, nutrients and quality beyond our expectations.

We are passionate about food and want to ensure you are able to enjoy all the flavor and goodness your food has to offer. The following pages have been included to offer you some helpful advice on how to keep your food fresher, tastier, nutritious and safer for longer, and how to get the best out of your *CoolDrawer™* food care system.

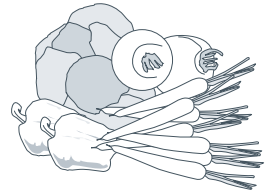



## Why do foods spoil?

The essence of optimum food storage is excellent food care.

The fundamental principle of improving food care is minimizing the quality losses associated with storage, including physical, chemical and microbiological changes, eg. moisture loss, bacterial growth, quality deterioration; and reducing the effects of undesirable factors, eg. dry air, light, unwanted moisture, odors, vibration and temperature fluctuations.

### **Foods spoil or deteriorate in quality for one or more of the following reasons:**

- The growth of bacteria, moulds or yeasts.
- Chemical or biochemical reactions
- Moisture loss
- Absorption of foreign odors or flavors

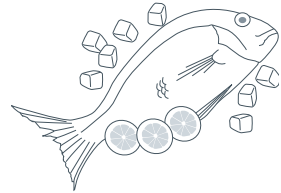

## How can you slow down food spoilage?

### **Temperature control**

Cold temperatures will slow down bacteria, mould and yeast growth. Remember the faster you chill or freeze your food the safer it will be from microbial growth and the better quality it will retain for longer. Once chilled to below 39°F / 4°C or frozen to 0°F / -18°C the temperature must be kept constant and accurate without large temperature fluctuations.

### **Chemical and biochemical reactions**

Such reactions occur naturally in fresh produce and are what cause foods to ripen and eventually to decay. Chemical reactions are slowed down at colder temperatures. This means your fruits and vegetables will ripen more slowly and therefore last longer when stored at refrigerator temperatures. The colder the temperature the slower this reaction will occur.

### **Moisture loss**

Most food contains at least 60% moisture. The air in a refrigerator is very cold and therefore will dry out foods over a period of time. It is recommended that food is covered or wrapped to prevent unnecessary moisture loss.

### **Absorption of foreign odors and flavors**

Exchange of odors can occur in many foods. Food such as eggs, butter and milk will absorb odors readily from fish. Fruit and eggs will also absorb flavor from onions. It is important to wrap odorous food to prevent this flavor transfer.

Your *CoolDrawer™* has constant and accurate temperature control, providing a stable environment for your food. This combined with rapid cooling and freezing rates reduces the rate at which food will deteriorate.

## Keeping food fresh

The quality of food before it is placed in the refrigerator is critical to successful storage.

### For best results:

- Select foods that are very fresh and of good quality.
- Buy only the amount that you will use within the recommended storage time. If you buy extra, plan to freeze it.

### Cover

- Ensure that food is well wrapped or covered before it is stored. This will prevent food from dehydrating, deteriorating in color or losing taste and will help maintain freshness. It will also prevent odor transfer. Vegetables and fruit need not be wrapped provided they are stored in the vegetable bins of the refrigerator.
- Make sure that strong smelling foods are wrapped or covered and stored away from foods such as butter, milk and cream which can be tainted by strong odors.

### Separate

- Store raw and cooked food in separate containers or packaging to prevent cross contamination.
- Store fruit and vegetables separately.

### Chill

- Refrigerate fresh, perishable foods as soon as possible after purchase. If left at room temperature for any length of time the rate of deterioration will be accelerated.
- Make sure that there is enough room for air to circulate freely around food items. Cold air needs to circulate to maintain safe food storage.
- Avoid opening the refrigerator drawer unnecessarily.
- Cool hot foods down before placing them in the refrigerator. This should be done quickly. It can be aided by placing the container of food in a bowl of ice and water; renew the ice as necessary. (Note also that hot containers may damage storage bins or trays in the appliance).

### In addition:

- Keep the compartment clean. Wipe the inside walls and shelves frequently and place only clean containers in the compartment.
- Check the quality of the food in your appliance regularly. Discard any food that shows signs of spoilage. Pay particular attention to meat, fish and poultry, as these foods are highly perishable.
- Use food within the recommended storage times.

## Dairy foods and eggs

- Most pre-packed dairy foods have a recommended use by / best before / best by date stamped on them. Store them using Fridge mode and use within the recommended time.
- Vacuum packed cheese should be kept unopened in the original packaging. Once opened, place in a sealed plastic bag, or wrap in foil to prevent drying out.
- Butter can become tainted by strong smelling foods so it is best stored in a sealed container.
- Eggs should be stored in the refrigerator. For best results, especially when baking, remove the eggs from the refrigerator two hours before they are to be used.



## Red meat

- Place fresh red meat in a covered container or loosely cover with waxed paper or plastic wrap or foil.
- Store cooked and raw meat separately. This will prevent any juices from the raw meat contaminating the cooked product.
- Delicatessen meats should be used within the recommended storage time.
- For best results, store fresh red meat using Chill mode.



## Poultry

- Fresh whole birds should be rinsed inside and out with cold running water. Dry and place on a plate. Cover loosely with plastic wrap or foil.
- Poultry pieces should also be stored this way. Whole poultry should never be stuffed until just before cooking, otherwise food poisoning may result.
- Cool and refrigerate cooked poultry quickly. Remove stuffing from poultry and store separately.
- For best results, store fresh poultry using Chill mode.



## Fish and seafood

- Whole fish and fillets should be used on the day of purchase. Until required, refrigerate covered with plastic wrap, waxed paper or foil.
- If storing overnight or longer, take particular care to select very fresh fish. Whole fish should be rinsed in cold water to remove loose scales and dirt and then patted dry with paper towels. Place whole fish or fillets in a sealed plastic bag.
- Keep shellfish chilled at all times. Use within 1 – 2 days.
- For best results, store fresh seafood using Chill mode.

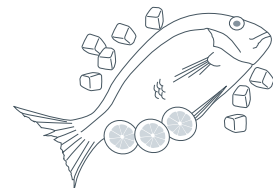

## **Important!**

*Always store raw meat, poultry, fish separately in the refrigerator to stop them dripping on or touching other foods.*

## Food storage tips – fresh food

### Precooked foods and leftovers

- These should be stored in suitable, covered containers so that the food will not dry out.
- Storage containers should be shallow to assist in rapid cooling.
- Keep for only 1 – 2 days.
- Reheat leftovers only once and until steaming hot.

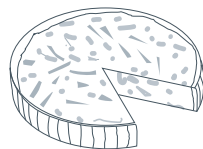

### How should cooked meats be stored?

- Cover all cooked meats to prevent drying and contamination from raw foods.
- Do not put piping hot meats in the refrigerator. Cool left-over cooked meat quickly after cooking, then refrigerate.
- Well cooked roasts will keep longer than very rare roasts.
- Leave a roast whole, loosely covered with foil, in a cool place until it has partly cooled. Then wrap securely with foil and place in the fridge.
- Leaving pieces whole prevents meat drying out.
- To limit contamination and bacterial growth, do not slice meat until just before use.
- Cured and smoked meats are less perishable than fresh meats. Leave pre-packaged items in their original wrappings or vacuum packs and refrigerate promptly. Once opened, keep tightly covered in the compartment set on Fridge mode and use before the expiry date.

### Herbs and spices

- Fresh herbs should be stored using Fridge mode.
- Dried herbs and spices, which gradually lose their strength and flavor when exposed to heat, light and air can be stored using Pantry mode.
- You can also seal fresh herbs in a freezer bag and keep them frozen for several months.

### Salad dressings and sauces

- Store opened jars of commercial mayonnaises on Fridge mode – make sure they are tightly sealed and they will keep for a number of months.
- Products such as mayonnaise, mustard and tomato sauce may develop brown or black crusts around the rim of the bottle as a result of oxidation. It's not harmful and doesn't mean the food is going off. Just wipe it off before use.

### Dried goods

- Seal packaging well before placing it into the compartment.
- Store dried goods, eg. flour, rice, cereal in Pantry mode in the warm months to reduce risk of insect infestation.

## Fruit and vegetable care

The consumption of fresh vegetables and fruit continues to rise. Busy lifestyles mean we shop less often and buy a greater range of fresh foods. It is important that these fresh foods, including fruit and vegetables, retain their flavor, texture and nutrients and stay safe to eat for as long as possible.

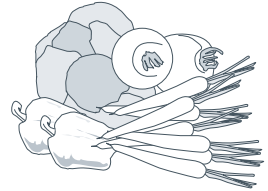

**There are three main reasons why fruit and vegetables deteriorate:**

### Respiration

Fruit and vegetables are highly perishable food products. They continue to ripen or respire after harvest. They use oxygen from the air to convert their natural sugars to heat energy, carbon dioxide and water. This causes the product to lose quality and food value. Refrigeration temperatures are the best method to slow down this natural respiration process. The colder the temperature the slower most fruit and vegetables will ripen.

### Micro-organism growth

Fruit and vegetables are usually covered with micro-organisms which will cause decay given the right conditions. When vegetables are bruised, or the skin is broken, decay organisms enter the product. Decay and rotting will then occur if it is exposed to warm temperatures. Adequate refrigeration is the best method of controlling decay because low temperatures slow down the growth of most micro-organisms.

### Moisture Loss

Another reason why fruit and vegetables deteriorate is loss of moisture which causes them to wilt and shrivel. Vegetables contain approximately 90% water and water loss is a major cause of deterioration. If vegetables are exposed to dry, refrigerator air, they will quickly dry out.

A high humidity, cold air environment is therefore necessary to extend the storage life of fruit and vegetables. This type of environment can be achieved by sealing the bins from the dry air in the refrigerator. This significantly increases the storage life of fruit and vegetables, ensuring they retain their crispness and remain a good source of essential vitamins, minerals and dietary fibre.

### How the Humidity Control System (HCS) extends the storage life of fruit and vegetables

A specially designed lid seals the storage bins to create a controlled micro-climate. The lid has the following unique features:

- It completely seals off the bins from the refrigerator air. The respiration of fruit and vegetables provide a high humidity environment in the bin and the lid prevents them from drying out.
- It allows the temperatures in the bin to remain between 32 – 39°F / 0 – 4°C. These temperatures are required to slow down respiration and the growth of micro-organisms.
- It has long narrow grooves on the underside to capture and retain condensation which has accumulated. This prevents the moisture from dripping back down onto the fruit and vegetables which would cause them to rot.

The storage life of fruit and vegetables varies enormously, being influenced by the maturity and quality of the produce at purchase and also the particular variety.

You can change the environment your fruit and vegetables are stored in simply by pressing the humidity control button.

### Temperature sensitive fruits and vegetables

Not all fruit and vegetables enjoy the same temperature. For some, temperatures that are too cold can actually cause damage to flavor, texture and freshness. For example chill injury can result in watery, tasteless tomatoes, stringy avocados and discolored bananas.

It is important to care for these food items and Pantry mode does just that. It provides a cool (54°F / 12°C) environment ideal for temperature sensitive foods. This temperature also allows fruit to ripen slowly under controlled conditions.

Some examples of temperature sensitive produce best stored using Pantry mode:

- Tomatoes
- Cucumber
- Avocado
- Bananas

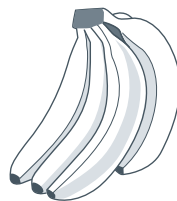

For more examples refer to page 16.

### Points to remember:

- Fruits and vegetables not fully ripe when purchased will have a longer storage life especially when refrigerated.
- Root vegetables should be kept in the dark. Light slowly turns their surface green, which makes them taste bitter and means they contain solanine, a chemical which is toxic in large doses. You can peel off small green patches, but if they are green all over, throw them away.
- Store root vegetables in brown paper bags on PANTRY mode.
- Store soft, small fruit in the compact storage tray.

## Ethylene Gas

Ethylene is an odorless, colorless, gas produced naturally by fruit and vegetables. This gas plays an important role in accelerating the ripening process. Some fruit and vegetables produce large amounts of ethylene, while others are very sensitive to the gas. You may have noticed that when you place an apple into the fruit bowl with bananas, the bananas will ripen more quickly. This is due to the ethylene gas given off by the apple.

By separating those items that produce high levels of ethylene from those that are most sensitive, you can prevent food from spoiling too quickly. As a general rule, separating fruit and vegetables will help reduce the effects of ethylene.

Examples:

Food sensitive to ethylene	Foods that produce high levels of ethylene
Avocados (unripe)	Apples
Brussel sprouts	Apricots
Broccoli	Avocados (ripe)
Cabbage	Cantaloupe
Carrots	Cherimoya (custard apple)
Cucumber	Passionfruit
Eggplant	Peaches
Kiwifruit	Pears
Lettuce	Tomatoes (ripe)
Persimmons	
Quince	
Spinach	
Tomatoes (unripe)	
Watermelon	

## Frozen food care

Freezing temperatures allow food to be kept for longer periods than when refrigeration temperatures are used. This is because:

- The growth of bacteria, moulds and yeasts is stopped
- Chemical and biochemical reactions are severely restricted.

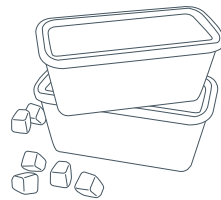

## Fast freezing of food

The faster you freeze your fresh food, the better the quality of the end product. During the freezing process ice crystals form within fresh food cells. These crystals can expand to a point where they break down the cell walls. This can cause 'drip loss' on thawing. Freezing food rapidly ensures that these ice crystals are kept as small as possible to retain quality of frozen foods.

Less drip loss means a more moist, more tender product on thawing, therefore retaining more of its nutritional value.

## ***Important!***

*Freezer storage times are dependent not only on temperature but also on the quality of food being stored and the use of the correct moisture and vapor-proof packaging.*



## For best results:

- Choose only high quality foods that freeze well.
- For optimum freezing results we recommend removing storage bins from the compartment and placing food directly on the trays.

## Temperature

- Store at 0°F / -18°C or colder. Take care to maintain this low storage temperature, eg. try to avoid opening the drawer unnecessarily.
- If your ice cream is soft you are running Freezer mode too warm.
- For general freezer storage select Freezer mode.
- For longer term storage select the Deep Freeze function. The lower temperature will preserve food for longer.

## Packaging

- Use good quality freezer proof packaging to maintain food quality. If food is only covered in plastic film, place inside a freezer-proof plastic bag.
- Leave space at the top of containers, glass jars or plastic bags containing liquids or semi-solid foods. These expand as they freeze. Usually 1 – 2 inches (20 – 50 mm) head space is recommended.
- Remove all the air from the packaging and seal tightly before freezing.
- When using the Deep Freeze function, ensure that freezer packaging is thick and airtight to reduce risk of freezer burn.

## Time

- Freeze immediately or as quickly as possible. For best results activate the Fast Freeze function.
- Keep a constant turnover of food. Use older items of food first. Do not exceed recommended storage times.
- Keeping food frozen past the recommended time will not affect food safety but will adversely affect the quality of the food.

## Amount

- Freeze only small quantities of food at any one time. For best results we recommend that only 2.2 lb (1 kg) food per 0.9 cu. Ft (25 L) of storage volume capacity.
- Do not pile frozen food around the air delivery vents at the rear of the compartment. It can prevent adequate air circulation.

## Thawing

- Thaw foods preferably in a refrigerator, or using a microwave oven or multifunction oven.

## Food storage tips – frozen food

### Meat, poultry and game

- Meat must be frozen quickly in order to maintain its texture.
- Do not stuff poultry before freezing.
- Red meat can be cooked from frozen, or from the partly or completely thawed states. Remember to allow extra cooking time if cooking from frozen.
- Always thaw poultry completely before cooking.



### Fish

- Fish is best frozen commercially. If however you do want to freeze fish at home, make sure the fish is very fresh and of high quality.
- Clean, scale and preferably leave whole. All fish should be wrapped in two layers of packaging as depending on the type of fish, odors and flavors can be readily transferred either to or from it. Seal packaging well.
- For best results, cook from either the frozen or partly thawed state.

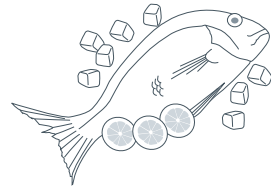

### Vegetables

- Most vegetables freeze well, although salad vegetables are not recommended as they will lose their crispness.
- Other vegetables, eg. celery, onion and tomatoes should only be used in cooked dishes as they soften on freezing.
- Freeze only high quality, mature, ready-to-eat vegetables.
- Sort and discard any that are damaged.
- **It is necessary to blanch most raw vegetables prior to freezing.** Blanching involves a short cooking period during which vegetable enzymes are destroyed. If these enzymes are not destroyed they cause undesirable physical and chemical changes during freezer storage. Vegetables can be blanched in boiling water, steam or in a microwave oven. If using boiling water, boil vegetables for 2 – 4 minutes and cool quickly.
- In general, frozen vegetables are best cooked from their frozen state.

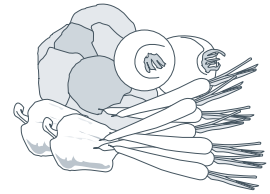

### Prepared and cooked foods

Most cooked foods can be frozen but it is not recommended to freeze the following:

- Cooked egg white, custards, cream fillings and milk puddings, gelatine or jelly-like dishes, mayonnaise and similar salad dressings, meringue toppings. These tend to separate on thawing.

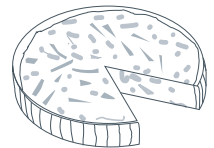

### Fruit

- Choose high quality, mature, and ready to eat fruit. Preferably select varieties recommended for freezing.
- Avoid unripe and over-ripe fruit.
- The way fruit is packed depends on how it is to be used. Fruits packed in syrup are ideal for desserts, whereas fruits packed without sugar are better used for cooking. Most fruits can be stored for 8 – 12 months.



## Keeping food safe

### **Important!**

*If highly perishable fresh food is not cooled and frozen quickly, harmful bacteria can grow and may cause food poisoning – anything from stomach upset to serious illness.*

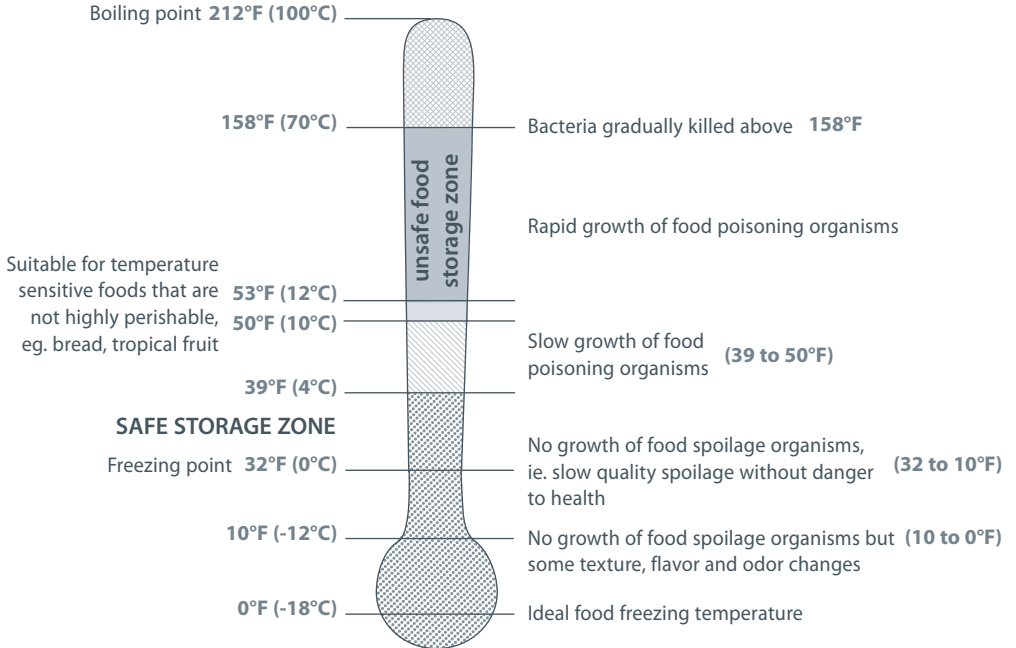

*Fig. 7 Identifying safe storage temperatures for highly perishable fresh food*

The bacteria that cause foodborne illness like *Campylobacter* and *Salmonella* multiply rapidly in warm, moist conditions. Fortunately the illnesses these bacteria cause are avoidable. By simply following the easy food handling tips below you could be helping to keep your family and friends safe from illnesses caused by foodborne bacteria.

### Clean

- Thoroughly wash and dry hands and work surfaces before preparing food.
- Keep cooked and raw food separate during preparation and storage, and use separate chopping boards and utensils to avoid cross contamination.
- After preparing food, clean all surfaces that have come into contact with food.

### Cook

- Defrost frozen foods in the refrigerator thoroughly before cooking.
- Minced meat and sausages should be cooked right through, and pork and poultry juices should run clear – use a meat thermometer to check temperatures.
- Pre-cook ground/minced meat, sausages and poultry before barbecuing.
- Put leftovers into the refrigerator as soon as they're cool.
- Reheat leftovers until steaming hot throughout and do not reheat more than once.
- Do not put cooked meat back on the same plate that held raw meat.

### Cover

- Always cover stored food – even in the fridge or cupboard.
- Keep raw meat and poultry covered in the bottom of the fridge and away from ready-to-eat food, fruit and vegetables to avoid dripping juices.
- When cooking or eating out doors, ensure that all food remains covered and cool until ready to cook or eat.
- Remember - the only time your food should be uncovered is when you're eating it!

### Chill

- Bacteria that cause foodborne illness thrive at room temperature - keep food very cold or very hot.
- Use shallow containers to chill food quickly.
- Keep all perishable foods in the fridge until you are ready to use them.
- A chiller bag is a good way of keeping chilled and frozen products cold when taking them home from the supermarket.
- While picnicking, keep food cool by using a frozen chilly pad or drink bottle.
- Defrost frozen foods in the fridge or microwave, and marinate food in the fridge, not on the bench.

## Cleaning

### **Important!**

*Many commercially available cleaning products contain solvents that may attack the plastic components of your appliance and cause them to crack and may cause rusting of metal components (antibacterial and citrus cleaners are especially harsh). It is important to use only warm water and a small amount of liquid dishwashing detergent on any components inside or outside your appliance.*

- It is important to keep the interior of the compartment clean to help prevent food from becoming contaminated during storage.
- The amount and types of food stored determines how often cleaning should be carried out (ideally once every 1 to 2 weeks).
- Do not use harsh, abrasive cloths or cleaner, or highly perfumed, strong smelling cleaners or solvents on any part of your appliance.

## Interior

- Remove the storage bins from the compartment and wash in a solution of warm water and liquid dishwashing detergent. Rinse the bins with clean water and dry before replacing in the compartment.
- The main storage tray can also be removed for cleaning. To remove the tray, slide the clips, located on the back sides of the tray, into the center of the tray (refer to fig 6). Ensure that the clips are pushed back to the sides once the tray is placed back into the cabinet.
- Wipe the control panel with a soft, damp, lint-free cloth.
- Wipe trays and interior surfaces with a soft, damp cloth and a solution of baking soda dissolved in warm water (1 teaspoon of baking soda to each pint (500 mls) of water).
- To help remove any lingering smells add a few drops of vanilla essence or vinegar to the water before cleaning.

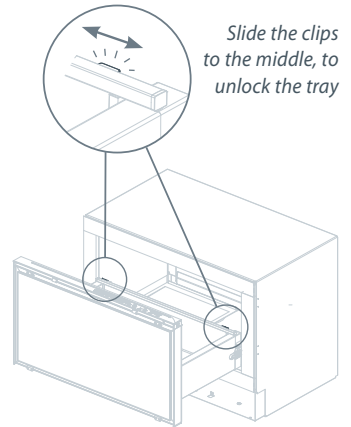

Fig. 8 Removal of storage tray

## Exterior

- Clean exterior surfaces with warm water and detergent.
- Use a toothbrush for the magnetic door gasket.
- The air inlet duct located on the bottom (refer to fig 7), left hand side of the product (accessed from the toe-kick area) should be cleaned at least once every 6 months with a cloth or vacuum cleaner. This will help prevent dirt or dust from blocking the inlet duct and reducing the efficiency of the product.

## Vacation time

We recommend you leave your appliance operating while you are on vacation. Remove all perishable food from the compartment.

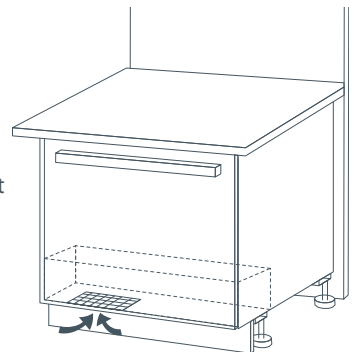

Fig. 9 Air inlet duct

## Before you call for service

### Please read the following pages before you call for service.

You can correct many of your appliances problems yourself using the checklists on the following pages.

Your appliance is capable of diagnosing its own problems. If it has a problem it will beep and display the service (spanner) icon to alert you.

Also check that:

- Your appliance is correctly installed.
- You are familiar with its normal operation.

	<b>If your appliance beeps for help and the service light (spanner) is flashing:</b>
	<ol style="list-style-type: none"><li>1 Turn your appliance off at the wall.</li><li>2 Wait 5 minutes and turn it back on.</li><li>3 Check your appliance is level and installed correctly (refer to installation instructions).</li><li>4 If the fault re-occurs call your Fisher &amp; Paykel Dealer</li></ol>

If the appliance will still not work, call your Fisher & Paykel Dealer or Authorized Service Agent to arrange a service visit (refer to page 53).

## Solving operating problems

Problem	Possible causes	What to do
<b>Appliance does not operate.</b>	No electricity at power outlet.	Check that the plug is correctly connected to outlet and that power is switched on. Could the household supply be at fault? Try plugging in another appliance at the same outlet.
	Power cord not attached at rear of appliance.	Has the appliance just been installed? Check your installation instructions to ensure the installer signed saying the product was working after installation then call an authorized service agent.
<b>Interior light and/or control panel not working.</b>	No electricity at power outlet.	Check that appliance is connected to power and power is switched on.
	Sabbath mode may be activated.	Press and hold the Lock and Mode Select buttons together for 4 seconds, until candle icon disappears.
	Light not functioning.	The light cannot be serviced by the user. Contact your Fisher & Paykel Dealer or Authorized Service Agent.
	Key Lock mode may be activated.	Is the Lock light on? If so, press and hold the Lock button for 3 seconds until the Lock light goes out.
<b>Motor operates for long periods</b>	Note: <b>This is normal.</b> This appliance uses an energy efficient variable speed compressor that saves energy by running for long periods of time on a low speed. This is more energy efficient than the conventional on/off method.	

## Solving operating problems

Problem	Possible causes	What to do
Unfamiliar noises coming from appliance.	Freezer is defrosting.	This is normal.
	Refrigerant noises, eg. cracking, popping, hissing, running water, humming.	This is normal. Refer to Operating Sounds section.
Condensation inside fresh food compartment.	Frequent or long drawer openings.	Minimize drawer openings.
	Drawer not sealing or closing properly.	Move items in compartment so drawer can close tightly. Check that seal is sitting flat and sealing tightly. Check that drawer skin is not clashing with surrounding cabinetry.
	High humidity environment.	May occur during periods of high humidity. Wipe dry.
Drawer hard to open or close. Tray or bin hard to pull out.	Appliance may not be level.	Refer to installation instructions.
	Slides not extending fully.	Hold onto sides of drawer or tray, extend the slides fully and evenly by using a firm pull on both sides. This will reset the slides.
	Food or packaging trapped.	Move items in compartment so drawer can close tightly.
	Drawer not sealing or closing properly.	Check that seal is sitting flat and sealing tightly.
	Note: When compartment is set to Freezer mode slides will not move as freely as they will when set to the Fridge modes due to low temperature.	
Slides not extending fully.		Hold onto sides of drawer or tray, extend the slides fully and evenly by using a firm pull on both sides. This will reset the slides.



### Solving operating problems

Problem	Possible causes	What to do
<b>Drawer skin not sitting flush with cabinetry.</b>	Drawer skin not fitted or adjusted correctly.	Adjust drawer skin. Refer to Installation instructions.
<b>Storage compartment too warm or too cold.</b>	Temperature setting not correct.	Refer to Temperature adjustment section.
	Frequent drawer openings.	Minimize drawer openings to allow temperature to stabilize.
	Warm, humid weather.	Minimize drawer openings to allow temperature to stabilize.
	Drawer not sealing or closing properly.	Move items in compartment so drawer can close tightly. Check that seal is sitting flat and sealing tightly. Check that drawer skin is not clashing with surrounding cabinetry.
	Large amount of food recently added.	Minimize drawer openings to allow temperature to stabilize.
	The storage mode of the compartment has recently been changed.	Wait for the storage mode icon on control panel to stop flashing and recheck temperature.
<b>Food freezing when set to Fridge mode.</b>	Temperature setting not correct.	Refer to Temperature adjustment section.
	Food placed directly in front of air outlets.	Move chill sensitive foods away from the back wall of the appliance.
<b>Food freezing when set to Chill mode.</b>	Temperature setting not correct.	Refer to Temperature adjustment section.
	Items with high water content may freeze.	Select Fridge storage mode.
<b>Ice buildup inside freezer compartment.</b>	Drawer not sealing correctly.	Move items in compartment so drawer can close tightly. Check that drawer seal (gasket) is sitting flat and sealing tightly.
	Frequent drawer openings.	Minimize drawer openings.
	High humidity environment.	Not unusual during periods of high humidity. Wipe out.

Solving operating problems

Problem	Possible causes	What to do
Small amount of frost on the inside, bottom left-hand side of the compartment.		This is normal.
Water in the storage bins.	Condensation is formed from the water vapor produced by fruit and vegetables.	A small amount of condensation is beneficial for fruit and vegetable storage.
		If there is too much water, set humidity control button to fruit  setting or store fruit and vegetables loosely wrapped in plastic bags.
		Wipe out water with a cloth.
Odor coming from appliance.	Initial 'new' smell from manufacturing.	This is normal and will disappear once the compartment is in operation.
	Strong smelling food that has not been covered or contained.	Cover all strong smelling and odorous foods carefully with food wrap or place food into sealed containers. Wipe compartment out with a mix of water and vanilla essence to reduce residual odor.
	Expired food.	Clear out old food from compartment. If in doubt, throw it out.
	Spills.	Clean up all spills as soon as they occur. Clean compartment with a mix of warm water and liquid dishwashing detergent. If a spill has escaped from large bottom tray and into the compartment, mop up as much of the spill as you can. If odor persists call an authorized service agent.

If problems persist, please contact your Fisher & Paykel Dealer, Customer Care Center or Authorized Service Agent to arrange service.

## For New Zealand, Australia, United Kingdom & Ireland markets only

You automatically receive a 2 year Manufacturer's Warranty with the purchase of this Product covering parts and labour for servicing within the country of purchase.

### Fisher & Paykel undertakes to:

Repair or, at its option, replace without cost to the owner either for material or labour any part of the Product, the serial number of which appears on the Product, which is found to be defective within TWO YEARS of the date of purchase.

### This warranty DOES NOT cover:

- A** Service calls that are not related to any defect in the Product. The cost of a service call will be charged if the problem is found not to be a Product fault. For example:
  - 1. Correcting the installation of the Product.
  - 2. Instructing the user how to use the Product.
  - 3. Replacing house fuses or correcting house wiring or plumbing.
  - 4. Correcting fault(s) caused by the user.
  - 5. Noise or vibration that is considered normal, eg. drain/fan sounds, refrigeration noises or user warning beeps.
  - 6. Correcting damage caused by pests, eg. rats, cockroaches etc.
- B** Defects caused by factors other than:
  - 1. Normal domestic use or
  - 2. Use in accordance with the Product's User Guide.
- C** Defects to the Product caused by accident, neglect, misuse or Act of God.
- D** The cost of repairs or service carried out by non-authorized service providers or the cost of correcting such unauthorised repairs or service.
- E** Normal recommended maintenance as set out in the Product's User Guide.
- F** Pick-up and delivery.
- G** Transportation or travelling costs involved in the repair when the Product is installed outside the authorised service provider's normal service area.

Service under this manufacturer's warranty must be provided by an Authorised Fisher & Paykel Service Provider (refer to the Service Contacts section at the start of this book). Such service shall be provided during normal business hours. This warranty certificate should be shown when making any claim.

### Note:

This Warranty is an extra benefit and does not affect your legal rights.

**Please keep this User Guide in a safe place.**

## **For USA and Canadian markets only**

When you purchase any new Fisher & Paykel whiteware product for personal or consumer use you automatically receive a two year limited warranty covering parts and labor for servicing within the 48 mainland United States, Hawaii, Washington DC and Canada. In Alaska the limited warranty is the same except that you must pay to ship the product to the service shop or the service technician's travel to your home. Products for use in Canada must be purchased through the Canadian distribution channel to ensure regulatory compliance.

If the product is installed in a motor vehicle, boat or similar mobile facility, you receive the same two year limited warranty, but you must bring the vehicle, boat or mobile facility containing the product to the service shop at your expense or pay the service technician's travel to the location of the product.

### **Fisher & Paykel undertakes to:**

Repair without cost to the owner either for material or labor any part of the product, the serial number of which appears on the product, which is found to be defective. In Alaska, you must pay to ship the product to the service shop or for the service technician's travel to your home. If the product is installed in a motor vehicle, boat or similar mobile facility, you must bring it to the service shop at your expense or pay for the service technician's travel to the location of the product. If we are unable to repair a defective part of the product after a reasonable number of attempts, at our option we may replace the part or the product, or we may provide you a full refund of the purchase price of the product (not including installation or other charges).

This warranty extends to the original purchaser and any succeeding owner of the product for products purchased for ordinary single-family home use.

All service under this limited warranty shall be provided by Fisher & Paykel or its Authorized Service Agent during normal business hours.

### **How long does this limited warranty last?**

Our liability under this limited warranty expires TWO YEARS from the date of purchase of the product by the first consumer.

Our liability under any implied warranties, including the implied warranty of merchantability (an unwritten warranty that the product is fit for ordinary use) also expires ONE YEAR (or such longer period as required by applicable law) from the date of purchase of the product by the first consumer. Some states do not allow limitations on how long an implied warranty lasts, so this limit on implied warranties may not apply to you.

## **This warranty does not cover:**

- A** Service calls that are not related to any defect in the product. The cost of a service call will be charged if the problem is not found to be a defect of the product. For example:
  - 1. Correcting faulty installation of the product.
  - 2. Instructing you how to use the product.
  - 3. Replacing house fuses, resetting circuit breakers, correcting house wiring or plumbing, or replacing light bulbs.
  - 4. Correcting fault(s) caused by the user.
  - 5. Changing the set-up of the product.
  - 6. Unauthorized modifications of the product.
  - 7. Noise or vibration that is considered normal, for example, drain/fan sounds, refrigeration noises or user warning beeps.
  - 8. Correcting damage caused by pests, for example, rats, cockroaches etc.
- B** Defects caused by factors other than:
  - 1. Normal domestic use or
  - 2. Use in accordance with the product's User Guide.
- C** Defects to the product caused by accident, neglect, misuse, fire, flood or Act of God.
- D** The cost of repairs carried out by non-authorized repairers or the cost of correcting such unauthorized repairs.
- E** Travel fees and associated charges incurred when the product is installed in a location with limited or restricted access. (eg. airplane flights, ferry charges, isolated geographic areas).
- F** Normal recommended maintenance as set forth in the product's User Guide.

If you have an installation problem contact your dealer or installer. You are responsible for providing adequate electrical, exhausting and other connection facilities.

We are not responsible for consequential or incidental damages (the cost of repairing or replacing other property damaged if the product is defective or any of your expenses caused if the product is defective). Some states do not allow the exclusion or limitation of incidental or consequential damages, so the above limitation or exclusion may not apply to you.

### Commercial use

If you are using the product in a commercial setting (any use other than a single family dwelling), we agree to repair or replace, without cost to you for parts only, any defective parts, the serial number of which appears on the product. Our liability for these repairs expires ONE YEAR from the date of original purchase.

At our option we may replace the part or the product, or we may provide you a full refund of the purchase price of the product (not including installation or other charges). All service under this limited warranty shall be provided by Fisher & Paykel or its Authorized Service Agent during normal business hours.

### No other warranties

This limited warranty is the complete and exclusive agreement between you and Fisher & Paykel regarding any defect in the product. None of our employees (or our Authorized Service Agents) are authorized to make any addition or modification to this limited warranty.

Warrantor: Fisher & Paykel Appliances, Inc.

If you need further help concerning this limited warranty, please call us at above number, or write to: **Fisher & Paykel Appliances, Inc. 5900 Skylab Road, Huntington Beach, CA 92647**

This limited warranty gives you specific legal rights, and you may also have other rights which vary from state to state.

## Before you call for service

Please read your User Guide. If you then have any questions about operating the product, need the name of your local Fisher & Paykel Authorized Service Agent, or believe the product is defective and wish service under this limited warranty, please contact your dealer or call us at:

### USA

TOLL FREE **1.888.9.FNP.USA (1.888.936.7872)**

or contact us through our web site: [www.fisherpaykel.com](http://www.fisherpaykel.com)

### Canada

TOLL FREE **1.888.9.FNP.USA (1.888.936.7872)**

or contact us through our web site: [www.fisherpaykel.ca](http://www.fisherpaykel.ca)

### Australia

TOLL FREE **1300 650 590**

or contact us through our web site: [www.fisherpaykel.com.au](http://www.fisherpaykel.com.au)

### New Zealand

TOLL FREE **0800 FP CARE or 0800 37 2273**

or contact us through our web site: [www.fisherpaykel.co.nz](http://www.fisherpaykel.co.nz)

### United Kingdom

TOLL FREE **(0845) 066 2200**

or contact us through our web site: [www.fisherpaykel.co.uk](http://www.fisherpaykel.co.uk)

### Ireland

TOLL FREE **01800 625 174**

or contact us through our web site: [www.fisherpaykel.ie](http://www.fisherpaykel.ie)

### For the rest of the world

Call your Fisher & Paykel Retailer/Dealer from whom you purchased the product. They are trained to provide information on your appliance. If we can be of any further help, please contact us on:

TOLL FREE **+64 9 273 0660**

or contact us through our web site: [www.fisherpaykel.co.nz](http://www.fisherpaykel.co.nz)

You may be required to provide reasonable proof of the date of purchase of the product before the product will be serviced under this limited warranty.

**Copyright © Fisher & Paykel 2008. Tous droits réservés.**

Les spécifications de produit contenues dans ce livret s'appliquent aux produits et aux modèles qui y sont décrits en date de la publication. En vertu de notre politique d'amélioration continue, ces spécifications peuvent changer à tout moment. Vous devriez donc vérifier auprès du centre de service à la clientèle pour vous assurer que ce livret décrit correctement les modèles présentement offerts.

**Derechos de autor © Fisher & Paykel 2008. Todos los derechos reservados**

Las especificaciones de los productos en este folleto aplican para los productos y modelos específicos descritos a la fecha de su emisión. De acuerdo con nuestra política de mejora continua de nuestros productos, estas especificaciones pudieran modificarse en cualquier momento. Por lo tanto, le invitamos a acercarse a nuestro Centro de Atención a Clientes para asegurarse de que este folleto describa en forma correcta el producto que acaba de adquirir.

**Copyright © Fisher & Paykel 2008. All rights reserved.**

The product specifications in this booklet apply to the specific products and models described at the date of issue. Under our policy of continuous product improvement, these specifications may change at any time. You should therefore check with our Customer Care Center to ensure this booklet correctly describes the product currently available.

**[www.fisherpaykel.com](http://www.fisherpaykel.com)  
[www.fisherpaykel.com.au](http://www.fisherpaykel.com.au)  
[www.fisherpaykel.co.uk](http://www.fisherpaykel.co.uk)  
[www.fisherpaykel.co.nz](http://www.fisherpaykel.co.nz)  
[www.fisherpaykel.ca](http://www.fisherpaykel.ca)**

US CA NZ AU UK IE IT

**CoolDrawer™**

Guide de l'utilisateur / Guía del Usuario / User guide

Publié / Fecha de publicación / Published: 03/2008

N° de pièce / Pieza No. / Part No. 840505