

# Installation Instructions

## Gas Dryer

Keep instructions for future reference. Be sure manual stays with dryer.

## Questions?

See *Owner's Manual* or call Amana Consumer Affairs Department 1-800-843-0304

### You'll Need a Few Things Before You Begin

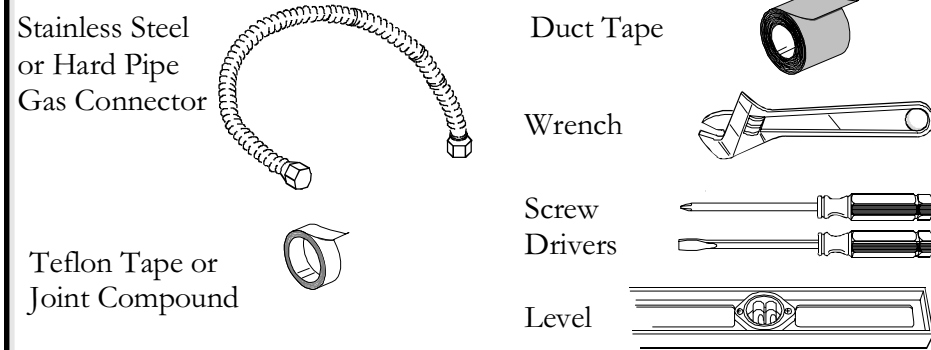

### Optional Kits

Kits are available at extra cost through your Amana dealer or Amana factory 1-800-843-0304.

**Directional Exhaust Kit**  
DK1 Sales Accessory (Directional Exhaust Kit #528P3).

**Flexible Metal Vent Kit**  
Exhausting the dryer in hard-to-reach locations can be accomplished by installing Kit # 521P3.

**Manufactured (Mobile) Home Installation Kit**

Manufactured home anchor Kit #526P3.

**Propane Gas Conversion Kit**  
LPK1 Sales Accessory (L.P./Propane Kit # 649P3).

## 1 REMOVE PARTS AND CLEAN DRYER DRUM

Wipe drum with clean rag and soap diluted in warm water to remove any oil used in manufacturing. Make a paste of laundry detergent and clean drum if necessary.

To reverse the direction that the door opens, see the *Owner's Manual*.

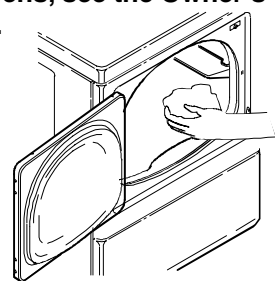

## 2 CONNECT DRYER TO EXHAUST SYSTEM

Secure all joints with clamps or duct tape. DO NOT use sheet metal screws or other fastening means which extend into the duct to attach exhaust pipe joints. They could catch lint and reduce the efficiency of the exhaust system.

**IMPORTANT:** Keep exhaust duct as short as possible.

Be sure old ducts are clean before installing your new dryer.

To prevent backdraft when dryer is not in operation, outer end of exhaust pipe must have a weather hood with hinged dampers (obtain locally).

Weather hood should be installed at least 12" (30.5 cm) above the ground. Higher clearances may be necessary in areas where heavy snowfall can occur.

No extra system length consideration is necessary when exhausting through the roof. Use *MAXIMUM EXHAUST LENGTH* table to calculate system length. Use a roof cap that provides air flow equal to weather hood.

### Exhaust Directions

Dryer can be exhausted to the outdoors through the back, right, or bottom of the dryer. **Gas dryers cannot be vented out the left side because of the burner housing.**

Dryer is shipped from factory ready for rear exhaust. **No kits required.**

To exhaust dryer through sides or bottom, install a DK1 Sales Accessory (Directional Exhaust Kit 528P3). Available as optional equipment at extra cost.

### Exhaust System Materials

Exhaust duct must be four inches (10.2 cm) in diameter without obstructions. Rigid metal duct is recommended. Non-combustible semirigid flexible metal duct is acceptable.

DO NOT use plastic pipe, foil pipe, or flexible plastic pipe, because it contributes to poor drying performance and collects lint, which can lead to a fire hazard. To identify flexible foil or plastic duct, pinch the coils of the duct between your fingers. If the coils can be brought together, do not use the duct.

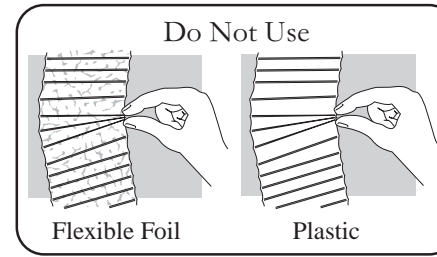
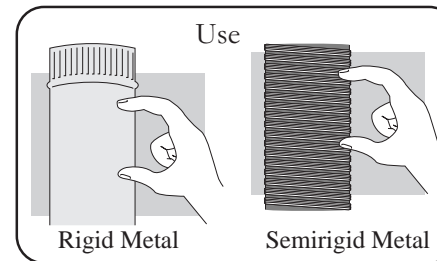

### Maximum Exhaust Length

Number of 90° Elbows	Rigid Metal Duct	
	Weather Hood 4-inch Opening	Weather Hood 2½-inch Opening
0	44 feet (13.4 m)	34 feet (10.4 m)
1	34 feet (10.4 m)	26 feet (7.9 m)
2	26 feet (7.9 m)	20 feet (6.1 m)
3	20 feet (6.1 m)	14 feet (4.3 m)

Number of 90° Elbows	Flexible Metal Duct	
	Weather Hood 4-inch Opening	Weather Hood 2½-inch Opening
0	24 feet (7.3 m)	20 feet (6.1 m)
1	20 feet (6.1 m)	16 feet (4.9 m)
2	16 feet (4.9 m)	12 feet (3.7 m)
3	12 feet (3.7 m)	8 feet (2.4 m)

**NOTE:** Deduct 6 feet (1.8 m) for each additional elbow.

### Recommended Weather Hood

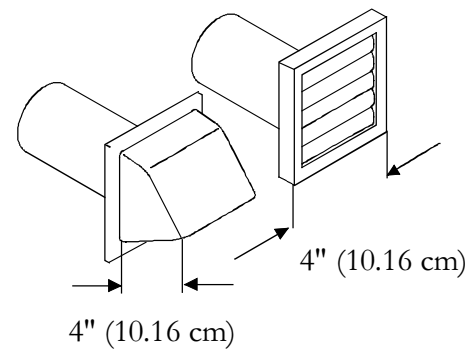

### Recommended for Short Runs Only

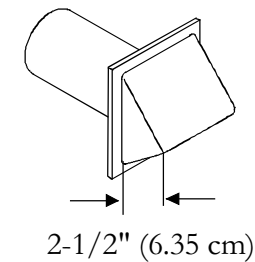

## 3 CONNECT GAS SUPPLY

### L.P./Propane

DO NOT connect dryer to L.P./Propane gas service without converting the gas valve. An LPK1 Sales Accessory L.P./Propane Gas Conversion Kit 649P3 must be installed.

### Test for Gas Leaks

After final gas connection is made, turn on manual gas valve and test all connections in gas supply piping for gas leaks. Leak testing of the appliance shall be conducted according to the manufacturer's instructions.

- Place soap suds on connections.
- If bubbles appear, a leak is present. Shut off gas supply valve.
- Tighten joint if leak is at factory fitting.
  - If leak is not at factory fitting, unscrew, apply more joint compound, and tighten to correct leak.
- Retest connection for leak after tightening or adding joint compound.
  - Retest any connections that were disturbed.

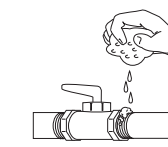

Connect gas supply to dryer using a new stainless steel flexible connector or hard pipe (check local codes) according to illustration. Test for leaks and check burner flame after gas supply is connected. See *Checking Burner Flame* section on next page.

- Dryer must be connected to type of gas as shown on nameplate located in the door recess.
- Use pipe joint compound insoluble on LP (propane) Gas, or Teflon tape, on all pipe threads.
- Purge air and sediment from gas supply line before connecting it to the dryer. Before tightening the connection, purge remaining air from gas line to dryer until odor of gas is detected. This step is required to prevent gas valve contamination.

### Use new stainless steel flexible connector

only if allowed by local codes (Use Design A.G.A. certified connector)

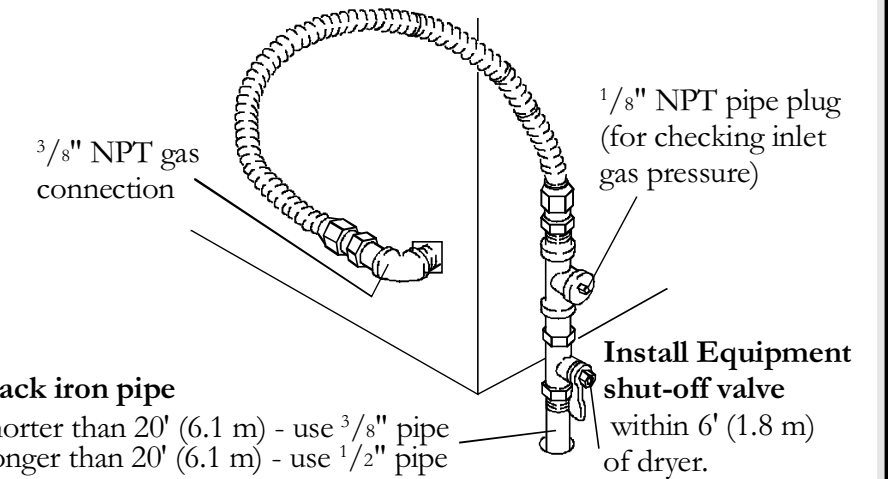

### Black iron pipe

Shorter than 20' (6.1 m) - use 3/8" pipe  
Longer than 20' (6.1 m) - use 1/2" pipe

### For proper operation at altitudes above 2,500 feet

The natural gas valve spud orifice size must be reduced to ensure complete combustion. See table.

Altitude Ft (M)	Orifice Size #	Part number
3000 (915)	43	503778
6000 (1830)	44	58719
8000 (2440)	45	503779
9000 (2740)	46	503780
10000(3050)	47	503781

## 4 CONNECT POWER CORD TO ELECTRICITY

See *Installation Requirements* section. Plug dryer into 3-prong grounded outlet only.

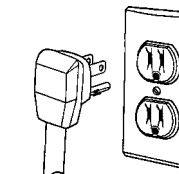

## 5 POSITION AND LEVEL DRYER

Place dryer in position, adjust all legs (4) until dryer is level side to side and front to back.

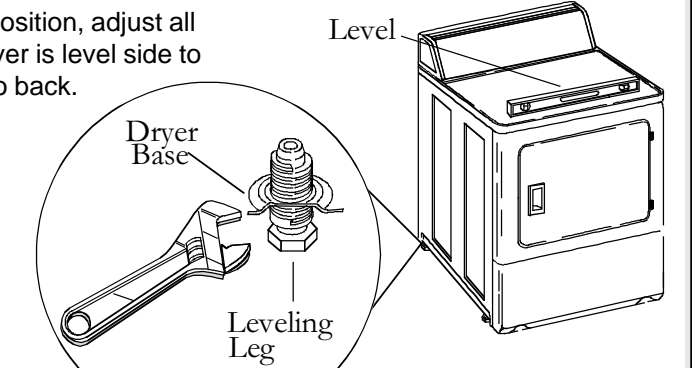

# Important Safety Information

## About Ground Wires

In the event of an electrical short circuit, a ground wire reduces the risk of electric shock by providing an escape wire for the electric current.

Standard accepted color coding for ground wires is **green** or **green with a yellow stripe**.

Grounding wires and wires colored like grounding wires are **NOT** to be used as current carrying conductors.

### WARNING

To avoid risk of personal injury or death:

- Do not allow children to play on or in the appliance. Close supervision of children is necessary when the appliance is used near children.

### WARNING

To avoid injury or death due to suffocation, remove door to dryer compartment before appliance is removed from service or discarded.

# Grounding Instructions

Dryer must be grounded. Dryer is equipped with a cord having a grounding conductor and a 3-prong grounding plug. The three-prong grounding plug on the power cord should be plugged directly into a polarized three-slot grounded receptacle rated 110/120V AC (alternating current) 15 Amps.

### WARNING

#### To avoid risk of personal injury or death due to electrical shock:

- Disconnect electrical power to unit before servicing.
- Ground appliance properly.
- Check with a qualified electrician if you are not sure this appliance is properly grounded, or that it has enough electrical power to operate the dryer.
- All wiring and grounding must conform with the latest edition of the National Electric Code, ANSI/NFPA 70, or the Canadian Electrical Code, CSA C22.1, and such local regulations as might apply.
- DO NOT ground to gas line.
- DO NOT ground to cold water pipe.
- DO NOT pinch power cord.
- DO NOT modify plug on power cord. If plug does not fit electrical outlet, have proper outlet installed by qualified electrician.
- DO NOT have a fuse in the neutral or ground circuit. A fuse in the neutral or ground circuit could result in an electrical shock.
- DO NOT use an extension cord with this appliance.
- DO NOT use an adapter plug with this appliance.

#### To avoid death, personal injury or property damage, from fire or explosion, information in this manual must be followed exactly:

- Do not store or use gasoline or other flammable vapors and liquids in the vicinity of this or any other appliance.
- DO NOT use plastic pipe, foil pipe, or flexible plastic pipe to exhaust the dryer.
- Never install flexible duct in concealed spaces, such as a wall or ceiling.
- Dryer must be exhausted to the outdoors. DO NOT exhaust dryer air into a window well, gas vent, chimney or enclosed, unventilated area, such as an attic, wall, ceiling, crawl space under a building or concealed space of a building.

#### WHAT TO DO IF YOU SMELL GAS

- Do not try to light any appliance.
- Do not touch any electrical switch; do not use any phone in your building.
- Immediately call your gas supplier from a neighbor's phone. Follow the gas supplier's instructions.
- If you cannot reach your gas supplier, call the fire department.
- Installation and service must be performed by a qualified installer, service agency or the gas supplier.

# Installation Requirements

Before You Install

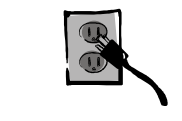
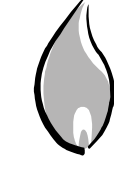
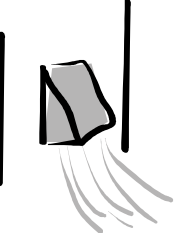
Consider	Description
 <p><b>Location</b></p>	<p>Use dimensions shown in manual to determine space needed for installation. Place dryer on a solid floor in an area with an adequate air supply. <b>A closet door must have two supply air vents with a minimum of 40 sq. in.(260 sq. cm.) each (see diagram).</b> No other fuel burning appliance should be installed in the same closet with the dryer.</p> <p>Dryer must not be installed or stored in an area where it will be exposed to water and/or weather.</p> <p><b>Manufactured (mobile) home installation</b> must conform to the Manufactured Home Construction and Safety Standards, Title 24 CFR, Part 32-80 or Standard CAN/CSA-Z240 MH.</p> <p>Gas dryers must be permanently attached to the floor at the time of installation. Order No. 526P3 Dryer installation Kit for a manufactured (mobile) home installation.</p>
 <p><b>Electrical Requirements</b></p>	<p>Dryer requires 120 volt, 15 amp, 60 Hz power supply and <b>3-prong grounding plug</b>. Power cord is approximately 69" long. Do not operate other appliances on the same circuit when this appliance is operating. Refer to serial plate for specific requirements. Wiring diagram is located in control hood.</p>
 <p><b>Gas</b></p>	<p>Natural Gas Pressure, 1000 Btu/ft3 (37.3 MJ/m3), service must be supplied at 6.5+1.5 inch water column pressure. L.P. (propane) Gas Pressure, 2,500 Btu/ft3 (93.1 MJ/m3), service must be supplied at 10 + 1.5 inch water column pressure.</p> <p>NOTE: The dryer and its appliance main gas valve must be disconnected from the gas supply piping system during any pressure testing of that system at test pressures in excess of 1/2 psi (3.45 kPa). Dryer must be isolated from the gas supply piping system by closing the equipment shut-off valve during any pressure testing of the gas supply piping system at test pressures equal to or less than 1/2 psi (3,45 kPa).</p> <p>When connecting to a gas line, an equipment shutoff valve must be installed within 6' (1.8 m) of the dryer. An 1/8" N.P.T. pipe plug must be installed.</p> <p>The gas service to a gas dryer must conform with the local codes and ordinances or in the absence of local codes and ordinances, with the latest edition of the National Fuel Gas Code ANSI Z223.1/NFPA 54 or the CAN/CGA-B149, National Gas Installation Code. LPK1 Sales Accessory (L.P./Propane Gas Conversion Kit 649P3) must be installed. DO NOT connect dryer to L.P./Propane Gas Service without converting the gas valve.</p>
 <p><b>Exhaust</b></p>	<p>Use rigid or semi-rigid metal duct and exhaust the dryer to the outside by the shortest route possible. Failure to exhaust dryer properly will void warranty.</p> <ul style="list-style-type: none"> <li>Dryer exhaust duct must be secured to the mobile home structure. Dryer exhaust duct MUST NOT terminate under the mobile home.</li> <li>Exhaust duct must not be connected to any other duct, vent or chimney.</li> <li>Venting materials are not supplied with the dryer. Do not use plastic or thin foil flexible ducting.</li> <li>Static pressure in the dryer's exhaust duct should be no greater than .6 inches (1.5 cm). Check with dryer running and no load. Measure with a manometer placed on the exhaust duct approximately two feet (61 cm) from the dryer.</li> </ul> <p><b>For the best exhaust system</b></p> <ul style="list-style-type: none"> <li>Locate dryer so exhaust duct is as short as possible.</li> <li>Verify old ducts are cleaned before installing new dryer.</li> <li>Use 4" (10.2 cm) diameter rigid or flexible metal duct.</li> <li>Use as few elbows as possible.</li> <li>Use duct tape on all joints.</li> </ul>

# Installation Checks and Adjustments

## Dryer Dimensions and Minimum Clearances

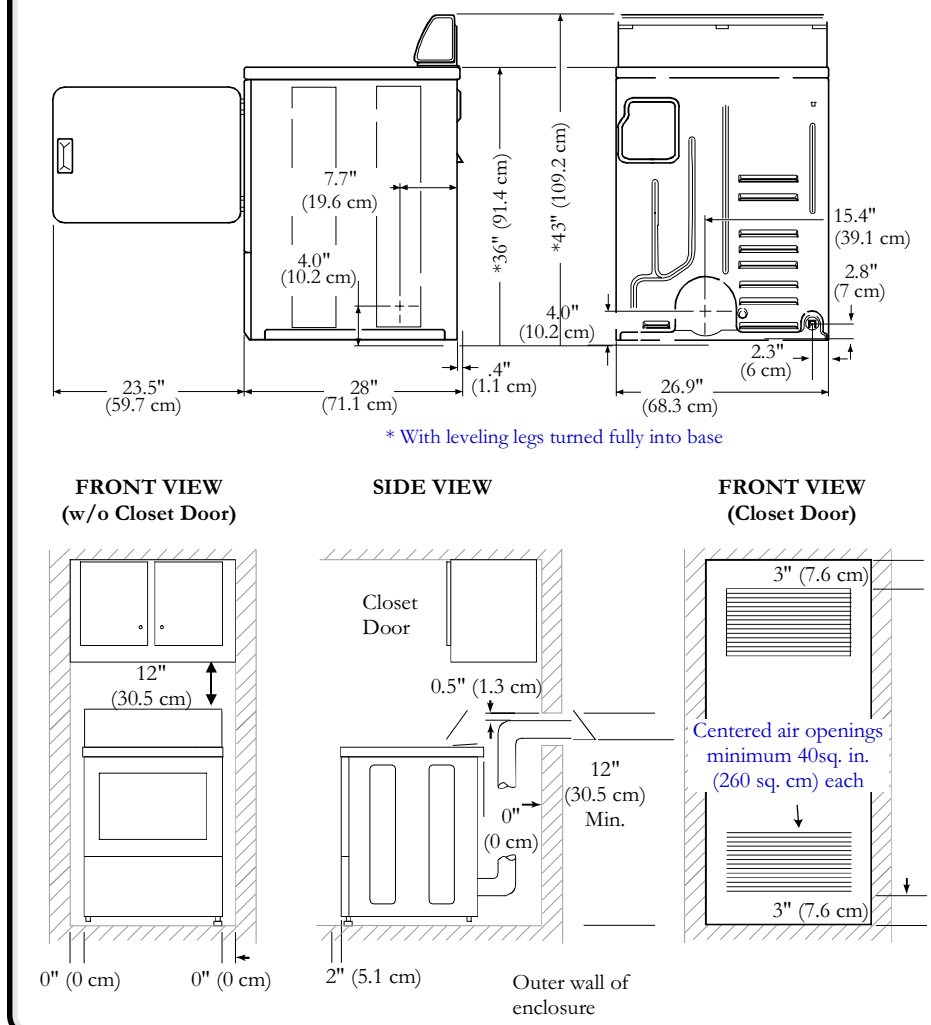

## Checking Burner Flame

To view the burner flame, remove the lower front panel of the dryer.

### WARNING

To prevent personal injury or property damage, front panel must be in place during normal operation.

Close the loading door, start the dryer in a heat setting (refer to Operating Instructions) The dryer will start, ignitor will glow red, and main burner will ignite.

**IMPORTANT: If all air is not purged out of gas line, gas ignitor may go off before gas is ignited. If this happens, after approximately two minutes ignitor will again attempt gas ignition.**

After the dryer has operated for approximately 5 minutes, observe burner flame through lower front panel. Adjust air shutter to obtain a soft, uniform blue flame. (A lazy, yellow tipped flame indicates lack of air. A harsh, roaring, very blue flame indicates too much air.)

## Adjusting Air Flow to Burner

- Loosen air shutter lock screw.
- Turn air shutter to left to get a luminous yellow-tipped flame, turn it back slowly to the right to obtain a steady, soft blue flame.
- After air shutter is adjusted for proper flame, tighten air shutter lock screw securely.

After the dryer has operated for approximately three minutes, exhaust air or exhaust pipe should be warm.

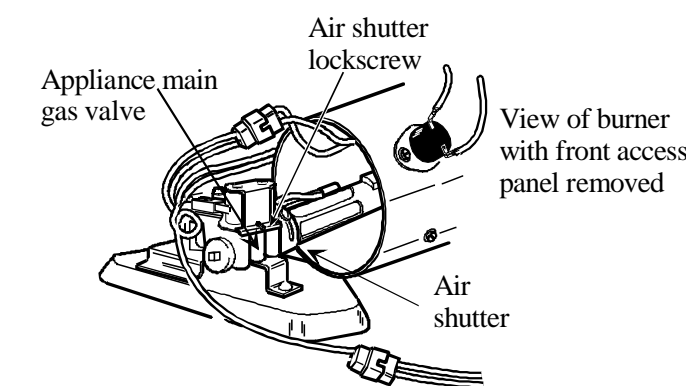

# Save These Instructions