



Use & Care Guide

Dual Fuel Slide-In Range



 **Electrolux**

Table of contents

Finding information	2
Safety	3-6
Features	7-11
Getting Started	12-13
• Power up, control display modes & timers	12
• Temperature visual display, control lock & oven lights	13
Surface Cooking	14-15
• Locations of the burners, placement of burner heads and caps	14
• Surface cooking utensils, flame size	15
Setting Surface Controls	16
• Setting surface controls	16
• Using the griddle.....	16
Setting the warmer oven	17
• Warmer oven operation	17
Setting Oven Controls	18-39
• Rapid preheat	18
• Bake	19
• Using cook time	20
• Using cook time with end time	21
• Broil	22-23
• Convection bake.....	24
• Using convection convert	25
• Convection roast.....	26-27
• Probe	28-29
• Keep warm	30
• Slow cook	31
• Perfect Turkey™	32
• Defrost	33
• Dehydrate	33-34
• Bread proof.....	34
• Saving & recalling my favorite recipes.....	35
• Multi stage cooking.....	36-37
• Setting Sabbath mode.....	38-39
Setting Your Preferences	40-45
• Setting clock	40
• Setting clock display (CLO)	40
• Setting 12 or 24 hour mode (CLO)	41
• Changing between F° or C° (F-C).....	41
• Setting 12hr energy saving mode (ES).....	42
• Setting audio mode (AUD).....	42
• Adjusting oven temperature (UPO)	43
• Factory default reset (RST)	43
Setting Self-Clean Cycle	44-45
Care and Cleaning	46-51
• Cleaning recommendations	46
• Special door care instructions	47
• Changing oven light.....	47
• Oven door removal	48-49
• Broiler pan cleaning tips	49
• Cleaning cooktop, burner grates, caps and heads	50-51
Solutions to Common Problems	52-54
Warranty	55

Please read & save this guide

Thank you for choosing Electrolux, the new premium brand in home appliances. This *Use & Care Guide* is part of our commitment to customer satisfaction and product quality throughout the service life of your new appliance.

We view your purchase as the beginning of a relationship. To ensure our ability to continue serving you, please use this page to record important product information.

Keep a record for quick reference

Purchase date

Electrolux model number

Electrolux serial number

Serial plate location

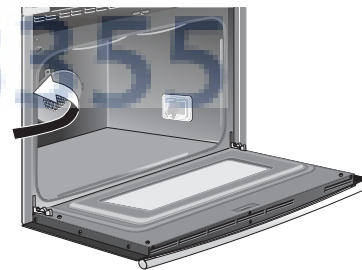

NOTE

Registering your product with Electrolux enhances our ability to serve you. You can register online at www.electroluxappliances.com or by dropping your Product Registration Card in the mail.

Questions?

For toll-free telephone support in the U.S. and Canada:

1-877-4ELECTROLUX (1-877-435-3287)

For online support and Internet production information visit <http://www.electroluxappliances.com>

What you need to know about safety instructions

Warning and Important Instructions appearing in this guide are not meant to cover all possible conditions and situations that may occur. Common sense, caution and care must be exercised when installing, maintaining or operating a microwave.

ALWAYS contact your dealer, distributor, service agent or manufacturer about problems or conditions you do not understand.

Recognize Safety Symbols, Words, Labels

WARNING

WARNING — Hazards or unsafe practices which **COULD** result in severe personal injury or death.

CAUTION

CAUTION — Hazards or unsafe practices which **COULD** result in minor personal injury.

WARNING

If the information in this manual is not followed exactly, a fire or explosion may result causing property damage, personal injury or death.

FOR YOUR SAFETY:

- Do not store or use gasoline or other flammable vapors and liquids in the vicinity of this or any other appliance.
 - **WHAT TO DO IF YOU SMELL GAS:**
 - Do not try to light any appliance.
 - Do not touch any electrical switch; do not use any phone in your building.
 - Immediately call your gas supplier from a neighbor's phone. Follow the gas supplier's instructions.
 - If you cannot reach your gas supplier, call the fire department.
 - Installation and service must be performed by a qualified installer, servicer or the gas supplier.
- **Remove all tape and packaging wrap before using the appliance. Destroy the carton and plastic bags after unpacking the appliance.** Never allow children to play with packaging material.
 - **Proper Installation—Be sure your appliance is properly installed and grounded by a qualified technician in accordance in United States with the National Fuel Gas Code ANSI Z223.1 latest edition, and National Electrical Code ANSI/NFPA No. 70 latest edition, and local code requirements, and in Canada with Canadian Standards CAN/CGA B149.1, and CAN/CGA B149.2 and Canadian**

WARNING



- All ranges can tip.
- Injury to persons could result.
- Install anti-tip device packed with range.
- See Installation instructions.

To reduce the risk of tipping of the range, the range must be secured by properly installed anti-tip bracket(s) provided with the range.

To check if the bracket (s) is installed properly, remove the lower panel or storage drawer and verify that the anti-tip bracket (s) is engaged. Refer to the installation instructions for proper anti-tip bracket(s).

Electrical Code, CSA C22.1 part 1, and local requirements. Install only per installation instructions provided in the literature package for this range.

Ask your dealer to recommend a qualified technician and an authorized repair service. Know how to disconnect the electrical power to the range at the circuit breaker or fuse box in case of an emergency.

- **User Servicing—Do not repair or replace any part of the appliance unless specifically recommended in the manuals.** All other servicing should be done only by a qualified technician to reduce the risk of personal injury and damage to the appliance.
- **Never modify or alter the construction of a range by removing leveling legs, panels, wire covers, anti-tip brackets/screws, or any other part of the product.**

4 Important Safety Instructions

WARNING

- **Stepping, leaning or sitting on the door or drawer of this appliance can result in serious injuries and may also cause damage to the appliance.** Do not allow children to climb or play around the appliance. The weight of a child on an open door may cause the appliance to tip, resulting in serious burns or other injury. An open drawer, when hot, may cause burns.
- **Do not use the oven or warmer drawer (if equipped) for storage.**
- **NEVER use this appliance as a space heater to heat or warm the room.** Doing so may result in carbon monoxide poisoning and overheating of the oven.

- **Storage in or on Appliance—Flammable materials should not be stored in an oven, near surface units or in the drawer (if equipped).** This includes paper, plastic and cloth items, such as cookbooks, plasticware and towels, as well as flammable liquids. Do not store explosives, such as aerosol cans, on or near the appliance. Flammable materials may explode and result in fire or property damage.

CAUTION

Do not store items of interest to children in the cabinets above the appliance. Children climbing on the range to reach items could be seriously injured.

- **Do not leave children alone. Children should not be left alone or unattended in the area where an appliance is in use.** They should never be allowed to sit or stand on any part of the appliance.
- **DO NOT TOUCH SURFACE BURNERS, AREAS NEAR THESE BURNERS, OVEN HEATING ELEMENTS OR INTERIOR SURFACES OF THE OVEN OR WARMER DRAWER (if equipped).** Both surface burners and oven heating elements may be hot even though surface burner flames are not visible or oven elements are dark in color. Areas near surface burners may become hot enough to cause burns. During and after use, do not touch, or let clothing or other flammable materials touch these areas until they have had

sufficient time to cool. Among these areas are the cooktop, surfaces facing the cooktop, the oven vent openings and surfaces near these openings, oven door and window.

WARNING

- **Never use your appliance for warming or heating the room.**
- **In case of fire or gas leak, be sure to turn off the main gas shutoff valve.**
- **Wear Proper Apparel—Loose-fitting or hanging garments should never be worn while using the appliance.** Do not let clothing or other flammable materials contact hot surfaces.
- **Do Not Use Water or Flour on Grease Fires—Smother the fire with a pan lid, or use baking soda, a dry chemical or foam-type extinguisher.**
- **When heating fat or grease, watch it closely.** Fat or grease may catch fire if allowed to become too hot.
- **Use Only Dry Potholders—Moist or damp potholders on hot surfaces may result in burns from steam.** Do not let the potholders touch hot heating surface units or interior oven elements. Do not use a towel or other bulky cloth instead of a potholder.
- **Do Not Heat Unopened Food Containers—Build up of pressure may cause the container to burst and result in injury.**
- **Remove the oven door from any unused appliance if it is to be stored or discarded.**
- **IMPORTANT—Do not attempt to operate the oven during a power failure. If the power fails, always turn the oven off.** If the oven is not turned off and the power resumes, the oven may begin to operate again. Food left unattended could catch fire or spoil.

CAUTION

Electronic controllers can be damaged by cold temperatures. When you use your appliance for the first time, or if it has not been used for a long period of time, make sure that it has been exposed to a temperature above 0°C/32°F for at least 3 hours before connecting it to the power supply.

IMPORTANT INSTRUCTIONS FOR USING YOUR COOKTOP

WARNING

- **Use proper flame size**—Adjust flame size so it does not extend beyond the edge of the utensil. The use of undersized utensils will expose a portion of the burner flame to direct contact and may result in ignition of clothing. Proper relationship of utensil to flame will also improve efficiency.
- Do not use stove top grills on the burner grates of sealed gas burners. If you use a stove top grill on a sealed gas burner, it will cause incomplete combustion and can result in exposure to carbon monoxide levels above allowable current standards. This can be hazardous to your health.
- **Know which knob controls each surface burner.** Place a pan of food on the burner before turning it on, and turn the burner off before removing the pan.
- **Always turn the knob to the full LITE position when igniting top burners.** Visually check that burner has lit. Then adjust the flame so it does not extend beyond the edge of the utensil.
- **Use Proper Pan Size**—This appliance is equipped with one or more surface burners of different sizes. Select utensils having flat bottoms large enough to cover the surface burner. The use of undersized utensils will expose a portion of the surface heating unit to direct contact and may result in ignition of clothing. Proper relationship of utensil to the surface unit will also improve efficiency.
- **Utensil Handles Should Be Turned Inward and Should Not Extend Over Adjacent Surface Burners**—To reduce the risk of burns, ignition of flammable materials, and spillage due to unintentional contact with the utensil. The handle of the utensil should be positioned so that it is turned inward, and does not extend over adjacent surface burners.
- **Never Leave Surface Burners Unattended**—Boilovers cause smoking and greasy spillovers that may ignite, or a pan that has boiled dry may melt.
- **Protective liners**—Do not use aluminum foil to line oven bottom or any other part of the appliance. Only use aluminum foil as recommended for baking if used as a cover placed on the food. Any other used of protective

liners or aluminum foil may result in a risk of electric shock or fire or a short circuit.

- **Glazed Cooking Utensils**—Only certain types of glass, glass/ceramic, ceramic, earthenware, or other glazed utensils are suitable for cooktop service without breaking due to the sudden change in temperature. Check the manufacturer's recommendations for cooktop use.
- **Air curtain or other overhead range hoods, which operate by blowing a downward air flow on to a range, shall not be used in conjunction with gas ranges other than when the hood and range have been designed, tested and listed by an independent test laboratory for use in combination with each other.**
- **Do not use Searing Grill on the cooktop.** The searing grill is not designed for use on the cooktop. Doing so may result in a fire.
- **Do Not Use Decorative Surface burner Covers.** If a burner is accidentally turned on, the decorative cover will become hot and possibly melt. Burns will occur if the hot covers are touched. Damage may also be done to the cooktop or burners because the covers may cause overheating. Air will be blocked from the burner and cause combustion problems.

IMPORTANT INSTRUCTIONS FOR USING YOUR OVEN

- **Use Care When Opening Door or Drawer**—Stand to the side of the appliance when opening the door of a hot oven. Let hot air or steam escape before you remove or replace food in the oven/warmer drawer.
- **Keep Oven Vent Ducts Unobstructed.** The oven is vented at the front above the oven door or through the rear of cooktop. Touching the surfaces in this area when the oven is operating may cause severe burns. Also, do not place plastic or heat-sensitive items on or near the oven vent. These items could melt or ignite.
- **Placement of Oven/Warmer Drawer (if equipped) Racks.** Always place oven racks in desired location while oven/drawer (if equipped) is cool. Remove all utensils from the rack before removing rack. If rack must be moved while oven is hot, use extreme caution. Use potholders and grasp the rack with both hands to reposition. Do not let potholders contact the hot oven element or interior of the oven/warmer drawer (if equipped).

6 Important Safety Instructions

- **Do not use a broiler pan without its insert.** The broiler pan and grid allow dripping fat to drain and be kept away from the high heat of the broiler.
- **Do not cover your broiler or warmer drawer (if equipped) grid with aluminum foil.** Exposed fat and grease could ignite.
- **Do not touch a hot light bulb with a damp cloth.** Doing so could cause the bulb to break. Disconnect the appliance or turn off the power to the appliance before removing and replacing light bulb.

IMPORTANT INSTRUCTIONS FOR CLEANING YOUR RANGE

- **Clean the range regularly to keep all parts free of grease that could catch fire.** Exhaust fan ventilation hoods and grease filters should be kept clean. Do not allow grease to accumulate. Greasy deposits in the fan could catch fire. Refer to the hood manufacturer's instructions for cleaning.
- **Cleaners/aerosols**—Always follow the manufacturer's recommended directions for use. Be aware that excess residue from cleaners and aerosols may ignite causing damage and/or injury.

SELF-CLEANING OVENS

- **Clean in the self-cleaning cycle only the parts of the oven listed in this owner's guide.** Before self-cleaning the oven, remove all utensils stored in the oven.
- **Do not clean the oven door gasket.** The door gasket is essential for a good seal. Care should be taken not to rub, damage or move the gasket.
- **Do not use oven cleaners.** No oven cleaner or oven liner protective coating of any kind should be used in or around any part of the oven.
- **Remove oven racks.** Oven racks will be damaged if left in the oven during a self-cleaning cycle.

CAUTION

The health of some birds is extremely sensitive to the fumes given off during the self-clean cycle of any range. Move birds to another well ventilated room.

Important safety notice

The California Safe Drinking Water and Toxic Enforcement Act requires the Governor of California to publish a list of substances known to the state to cause cancer, birth defects or other reproductive harm, and requires businesses to warn customers of potential exposure to such substances.

800-570-3355

SAVE THESE INSTRUCTIONS FOR FUTURE REFERENCES

Wave-Touch™ oven features & options

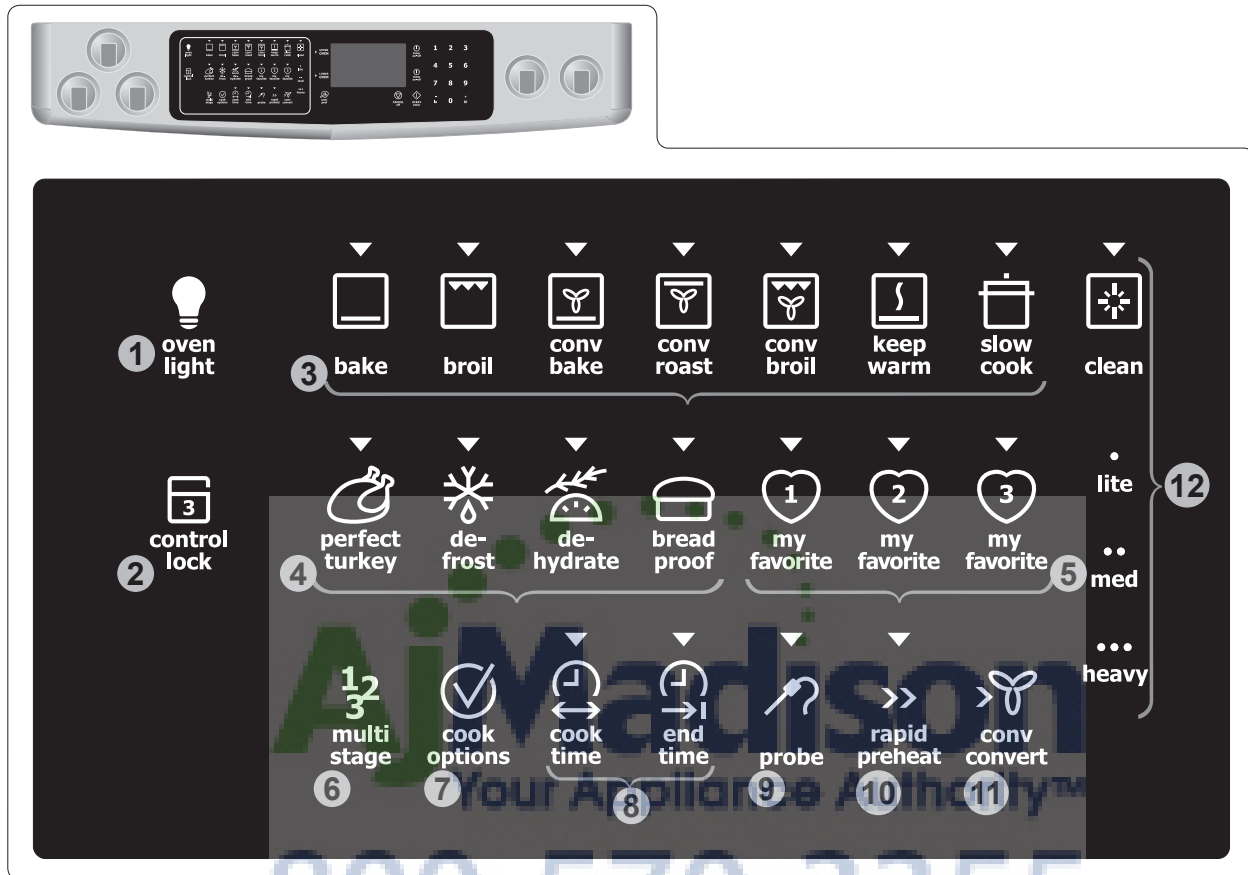

1. Oven light
2. Control lock
3. Standard cooking
 - Bake
 - Broil
 - Perfect-Convect³™ convection bake
 - Perfect-Convect³™ convection roast
 - Perfect-Convect³™ convection broil
 - Keep warm
 - Slow cook
4. Specialized cooking
 - Bread proof
 - Perfect Turkey™
 - Defrost
 - Dehydrate
5. Favorite settings
6. Perfect Program™ multi stage cooking
7. Cook options
 - Cook time
 - End time
8. Cooking time
9. Probe
10. Rapid preheat
11. Convection convert
12. Cleaning
 - lite
 - med
 - heavy

Minimum & maximum control settings

Feature	Min. temp	Max. temp
Bake	170°F / 76°C	550°F / 288°C
Bread Proof	85°F / 30°C)	100°F / 38°C
Broil	300°F / 148°C	550°F / 288°C
Conv Bake	170°F / 76°C	550°F / 288°C
Conv Roast	170°F / 76°C	550°F / 288°C
Conv Broil	300°F / 148°C	550°F / 288°C
Keep Warm	150°F/66°C	190°F/88°C
Slow Cook	Lo (225°F / 108°C)	Hi (275°F / 135°C)
Dehydrate	100°F / 38°C	225°F / 108°C
Perfect Turkey	300°F / 148°C	550°F / 288°C

Wave-Touch™ control display & keys

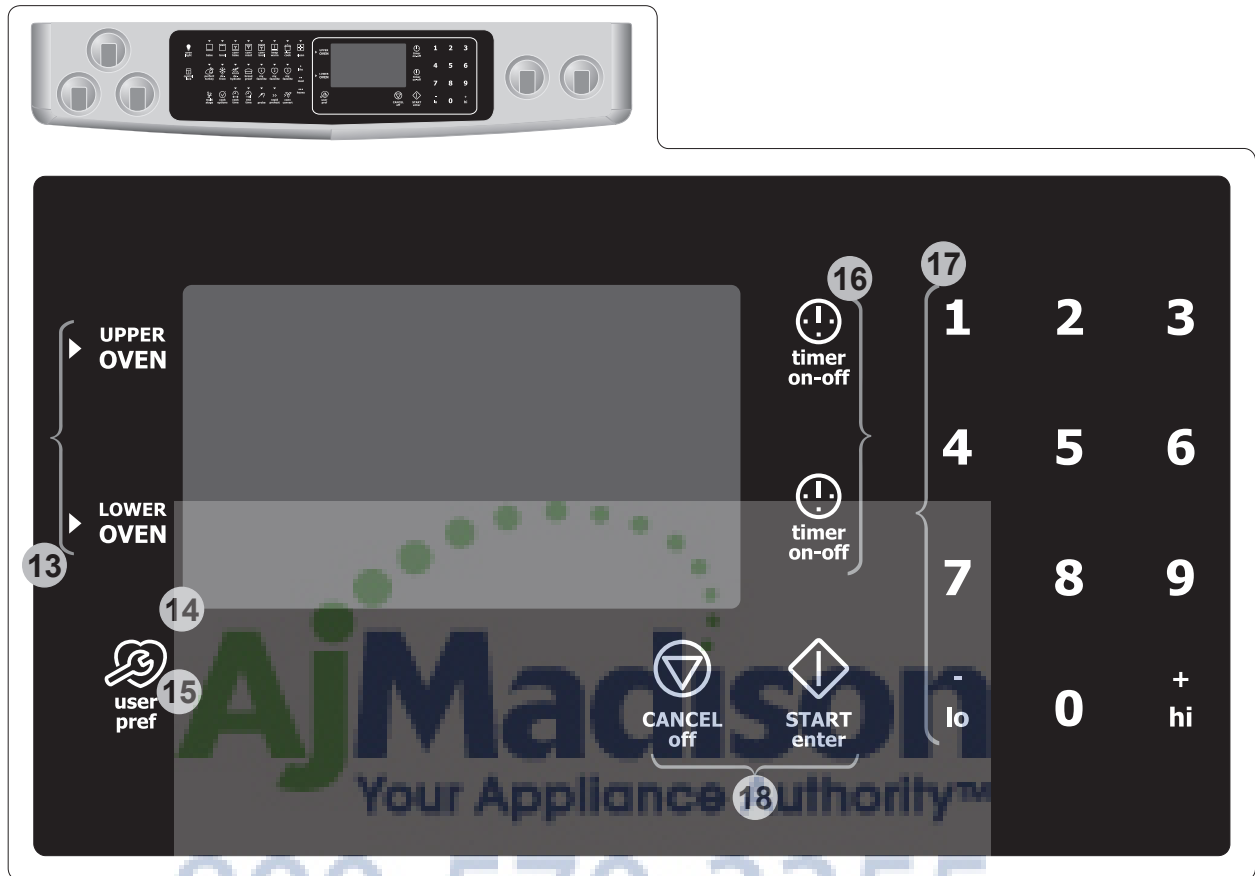
**13. Perfect-Pair™ oven key pads**

- Upper oven
- Lower oven

14. Oven display**15. User preferences**

The following options are available under User Preferences:

- Clock setting
- Clock display setting
- 12 hr/ 24 hr
- Fahrenheit / Celsius
- 12 Hr energy save mode on/off
- Audio mode
- Temperature adjustment (UPO offset)
- Factory default reset

16. Timers**17. Numeric key pads****18. Cancel & Start key pads****Minimum & maximum time settings**

Feature	Min. time	Max. time
Timer 1	1 min	11 hr 59 min
Timer 2	1 min	11 hr 59 min
Clock 12 hr	1:00 hr	12 hr 59 min
Clock 24 hr	0:00 hr	23 hr 59 min
Cook time 12 hr	1 min	11 hr 59 min
Cook time 24 hr	1 min	11 hr 59 min
End time 12 hr	1:00 hr	12 hr 59 min
End time 24 hr	0:00 hr	23 hr 59 min
Clean duration	Lite (2 hr)	Heavy (4 hr)

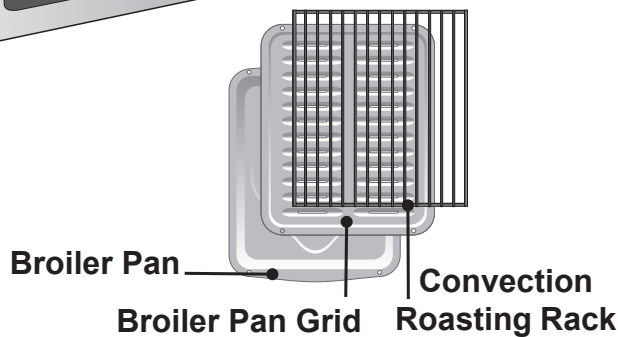
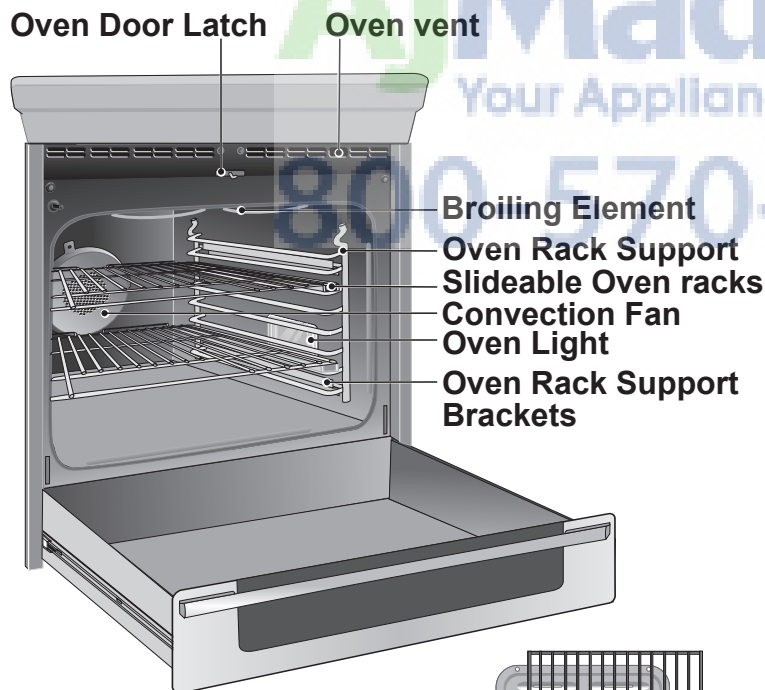
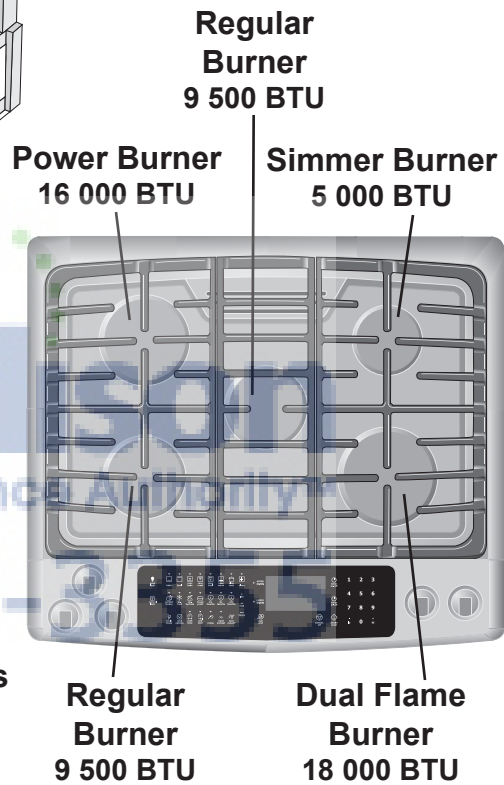
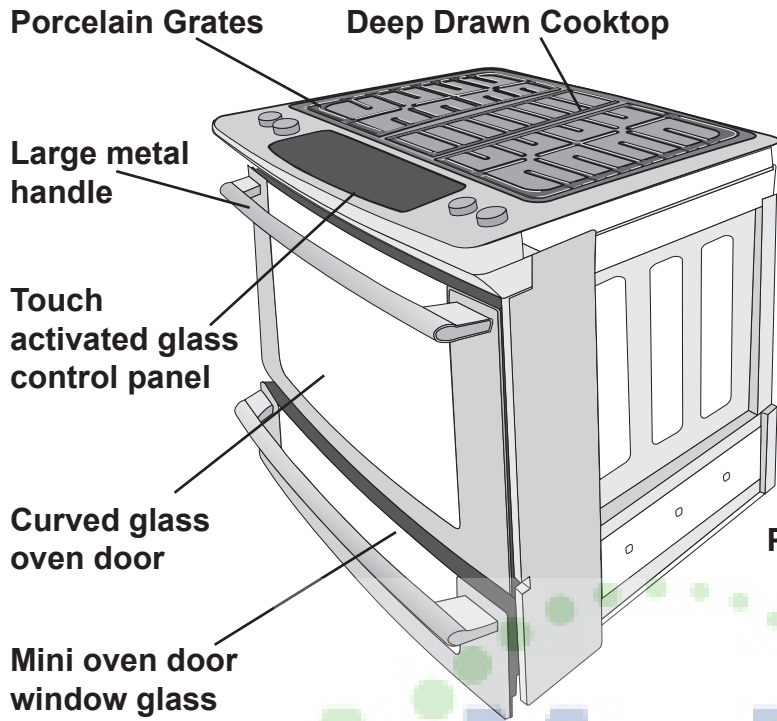

Oven vents location

The oven is vented above each door. When the oven is on, warm air is released through the vents. This venting is necessary for proper air circulation in the oven and good baking results.

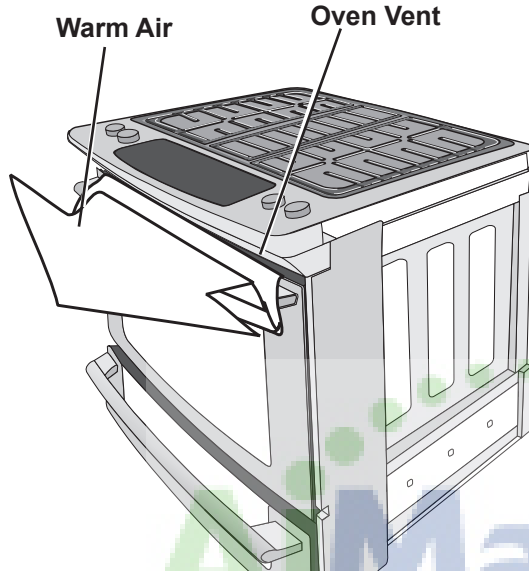

Oven rack position

This oven is equipped with ladder rack supports with 7 positions to accommodate precisely every mode of cooking.

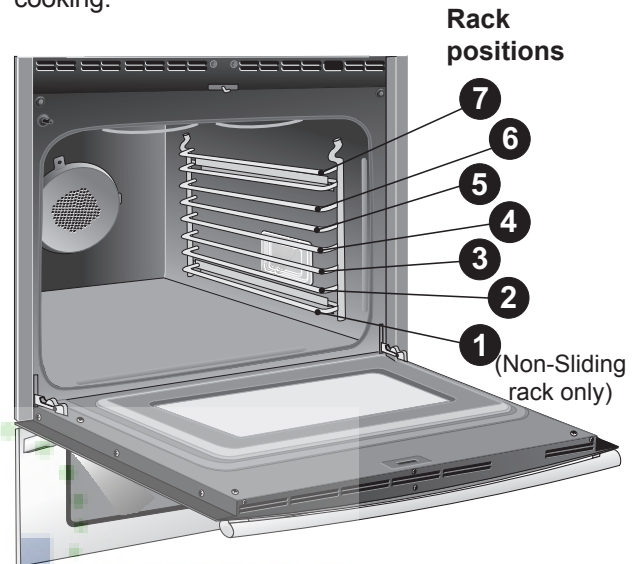

Installing oven rack supports

ALWAYS INSTALL OVEN RACK SUPPORT BEFORE TURNING ON THE OVEN (WHEN THE OVEN IS COOL).

To install oven rack support, insert the supports by pushing them downward into the two brackets on each side of the oven interior, as shown below.

To remove the oven rack support for a self-clean cycle, pull up the support to disengage them from the brackets. If the rack supports are not removed, the self-clean cycle won't start.

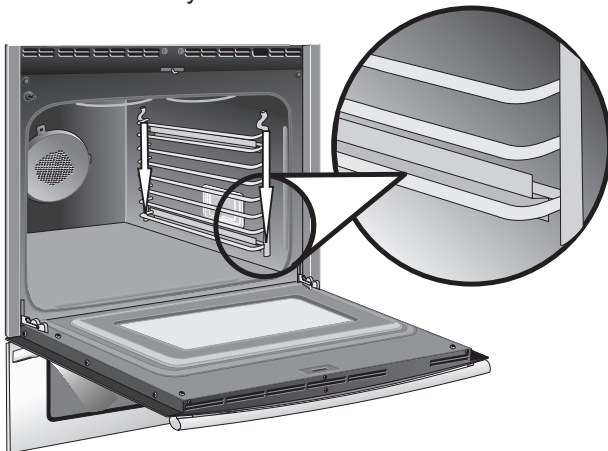

Removing and replacing oven racks

Removing Sliding Oven Racks

1. With the rack in its closed position; grasp the rack and the sliders at once.
2. Slightly lift the rack and sliders and pull it to clear the first bracket.
3. Pull the rack and sliders until the second bracket stops the rack.
4. Lift the rack and sliders and carefully remove them from the oven.

Replacing Sliding Oven Racks

To replace the oven racks, follow the instructions above in reverse order.

Refer to the care and cleaning section for directions on how to clean the racks.

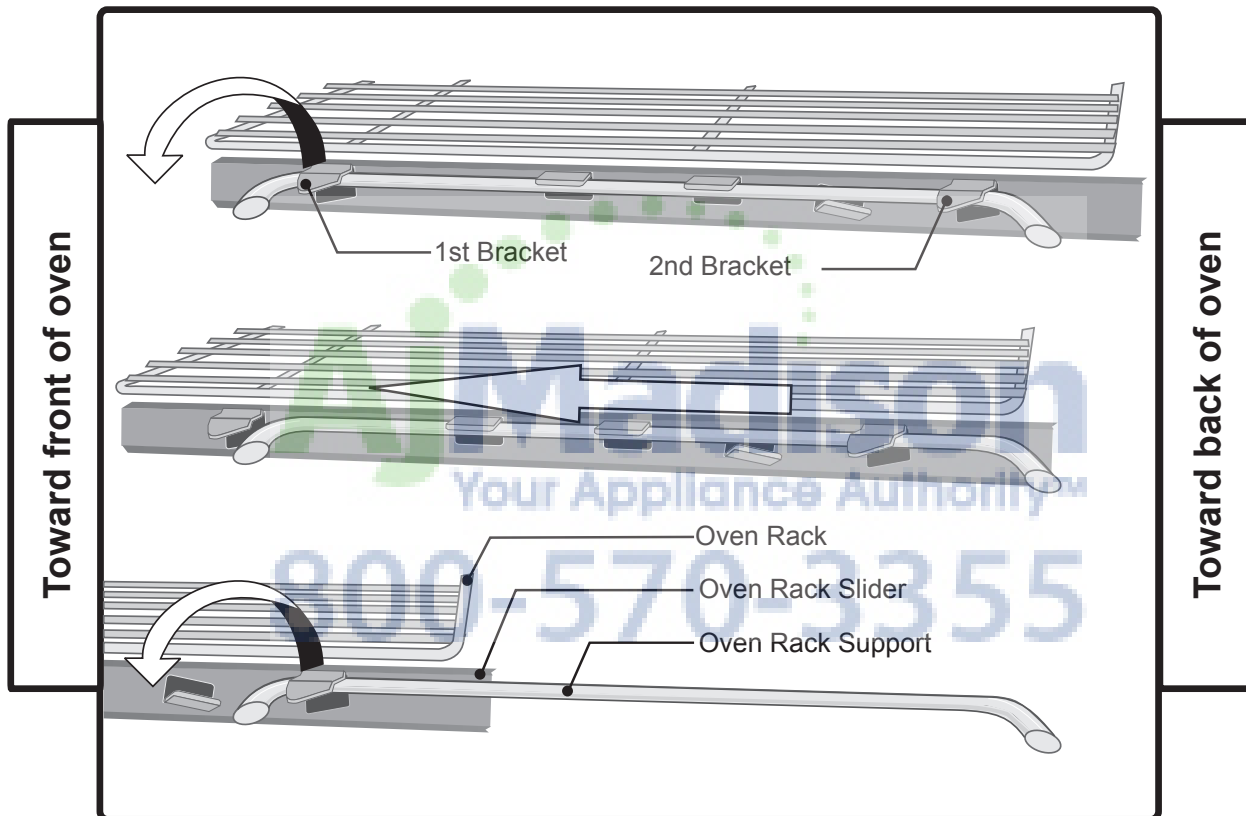

Removing Non-Sliding Oven Rack

Simply pull the rack and slightly tilt it upward when the rack hits its stop position.

Replacing Non-Sliding Oven Rack

Insert the rack into the oven rack supports by inserting the rack openings into the rack supports. Be sure the rack is at the same position on each oven rack support on both sides.

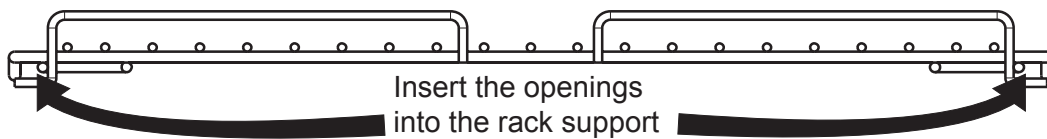

WARNING

Always arrange the oven racks when the oven is cool (prior to operating the oven). Always use oven mitts when using the oven.

12 Getting Started

Setting clock at power up

You will be prompted to enter the time of day in the event of a power failure or when you first provide electric power to your appliance.

- When your appliance is first powered up, 12:00 will flash in the display.
- Enter the time of day using the numeric key pads and press **START** to set.

If an invalid time of day is entered, the control will triple beep. Re-enter a valid time of day and press **START**. If **CANCEL** is pressed your clock will start with the time set for **12:00**.

Select the user pref key to modify the time of day during other situations such as day light savings.

Wave-Touch™ display modes

Sleep mode

Your control will remain in a sleep mode when not in use. Only the clock will display during this mode. You will need to wake the control to begin any function - Fig. 1.

Awake mode

To awake the control touch within the display panel. If the control panel is not touched again within 2 minutes, the control will return to the sleep mode. To start cooking you must select either the upper oven or the lower oven. User preferences will be available during the awake mode as well as timers, oven light and the control lock - Fig. 2.



Timers

The two timers provided with the oven control serve as extra reminders in the kitchen. When a timer reaches less than 1 hour, the display will start to count down in minutes and seconds. When the time runs out the active timer will beep, "0:00" will flash.

The following time settings apply to the timers:

- Min. time: 1 minute
- Max. time: 11 hours 59 minutes

See example below to set the timer for 5 minutes:

Example	
Step	Press
1. Press TIMER	
2. Enter 5 minutes	5
3. Press TIMER	

To cancel after setting the timer, press the **TIMER** key again.

NOTE

The timer(s) will not affect the cooking process.



Sleep mode

Fig.1



Awake mode

Fig.2

Temperature visual display

Your oven is equipped with a temperature visual display for each oven. When a cooking mode is set, the actual temperature will be shown in the display and will rise as the unit preheat. When the unit has reached its target temperature, a chime will sound to remind you to place the food in the oven. This feature will be active with some cooking modes; bake, convection bake, convection roast and perfect turkey. The cooking modes which does not feature the temperature visual display will be noted in their descriptions.

NOTE: The lowest temperature that can be displayed is 100°F.

Interior Oven Light

Your appliance includes “theater” style oven lighting feature that gradually lights both the upper and lower oven interiors to full brightness. The upper oven is equipped with 2 halogen lights and the lower oven is equipped with 1 incandescent light. The oven lights will turn on automatically when the oven door is opened. The oven light may be turned on when the door is closed by using the oven light pad located on the control panel. The oven light key will toggle the lights in both ovens at the same time at full intensity.

To toggle the oven light ON and OFF:



1. Press .

Control lock

The control lock will lock both oven controls and the lower oven door.

Control lock is available only in the awake mode.

See example below to lock the ovens.

Example	
Step	Press
To lock, press and hold CONTROL LOCK for 3 seconds.	 3sec
To unlock, press and hold CONTROL LOCK for 3 seconds.	 3sec

DOOR  will flash in the display until the door has finished locking. Once the door has been locked the door lock indicator will turn on. LOCKED will then display.

Do not attempt to open the oven door while the door lock indicator is flashing.

Madison
Appliance Authority™
800-570-3355

14 Surface Cooking

Locations of the burners

The cooktop is equipped with different sized burners.

The surface burners are located on the cooktop as follows (See Figure):

- a **5 000 BTU** (natural gas) burner located at the right rear position;
- a **18 000 BTU** (natural gas) burner located at the right front position;
- a **9 500 BTU** (natural gas) burner located at the left front position;
- a **16 000 BTU** (natural gas) burner located at the left rear position;
- a **9 500 BTU** (natural gas) burner located at the center position.

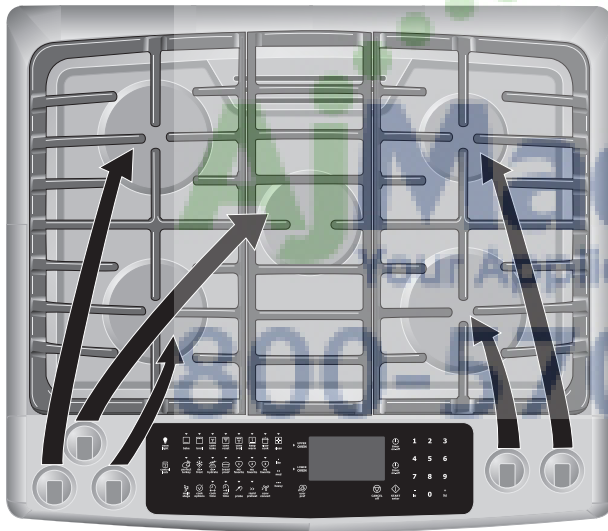

Placement of burner heads and caps

For the 18 000 BTU burner :

Place the burner head over the gas orifice (Figure 2). **Be careful not to damage the electrode while placing the burner head over the orifice.** Make sure electrode fits correctly into slot in burner head.

For all burners :

Place a burner cap on each burner head (see Figure 1), matching the cap size to the head size. The cap for each burner has an inner locating ring which centers the cap correctly on the burner head. Be sure that all the burner caps and burner heads are correctly placed **BEFORE** using your appliance.

Make sure each burner cap is properly aligned and level.

Turn the burner on to determine if it will light. If the burner does not light, contact a Service Center. Do not service the sealed burner yourself.

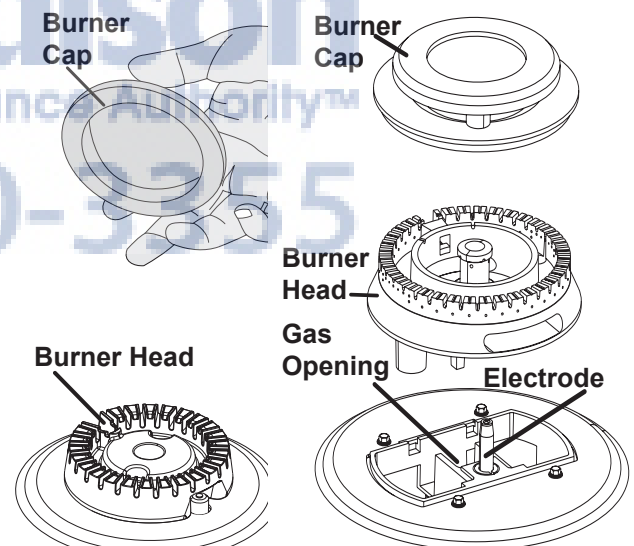

Figure 1

Figure 2

Proper burner adjustments

The color of the flame is the key to proper burner adjustment. A good flame is clear, blue and hardly visible in a well-lighted room. Each cone of flame should be steady and sharply defined. Adjust or clean burner if flame is yellow-orange. To clean burner, see instructions under **General Care & Cleaning**.

Surface cooking utensils

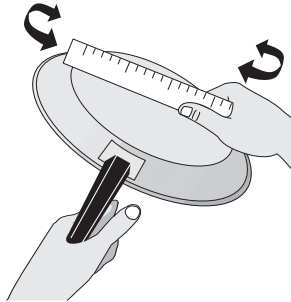

Pans should have flat bottoms. Check for flatness by rotating a ruler across the bottom. There should be no gaps between the pan and ruler.

* Specialty pans such as lobster pots, griddles and pressure cookers may be used but must conform to the above recommended cookware requirements.

*GOOD



- Flat bottom and straight sides.
- Tight fitting lids.
- Weight of handle does not tilt pan. Pan is well balanced.
- Pan sizes match the amount of food to be prepared and the size of burner.
- Made of material that conducts heat well.
- Easy to clean.

POOR

- Curved and warped pan bottoms.



- Pan overhangs unit by more than 2.5 cm (1").



- Heavy handle tilts pan.



- Flame extends beyond unit.



Note: Always use a utensil for its intended purpose. Follow manufacturer's instructions. Some utensils were not made to be used in the oven or on the cooktop.

Flame size

For most cooking, start on the highest control setting and then turn to a lower one to complete the process. Use the chart below as a guide for determining proper flame size for various types of cooking. The size and type of utensil used and the amount of food being cooked will influence the setting needed for cooking.

For deep fat frying, use a thermometer and adjust the surface control knob accordingly. If the fat is too cool, the food will absorb the fat and be greasy. If the fat is too hot, the food will brown so quickly that the center will be undercooked. Do not attempt to deep fat fry too much food at once as the food will neither brown nor cook properly.

*Flame Size	Type of Cooking
High Flame	Start most foods; bring water to a boil; pan broiling
Medium Flame	Maintain a slow boil; thicken sauces, gravies; steam
Low Flame	Keep foods cooking; poach; stew.

*These settings are based on using medium-weight aluminum pans with lids. Settings may vary when using other types of pans.

Never extend the flame beyond the outer edge of the utensil. A higher flame simply wastes heat and energy, and increases your risk of being burned by the flame.

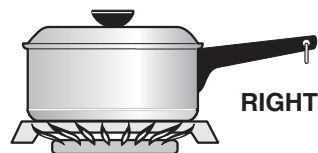

16 Setting Surface Controls

Setting surface controls

Your cooktop may be equipped with any combination of the following burners:

Simmer Burner: best used for simmering delicate sauces, etc.





Standard Burner: used for most all surface cooking needs.

Large Burner: best used when bringing large quantities of liquid to temperature and when preparing larger quantities of food.

Regardless of size, always select a utensil that is suitable for the amount and type of food being prepared. Select a burner and flame size appropriate to the pan. Never allow flames to extend beyond the outer edge of the pan.

Your cooktop is also equipped with 270° rotation flame control valves. These valves provide enhanced control of the burner flame. Each burner lights automatically from an electric ignitor when its control knob is turned to the **LITE** position.

To operate the surface burner:

1. Place cooking utensil on burner.
2. **Push in and turn** the Surface Control knob to  (**LITE**). For dual flame burner, make sure to keep the knob setting between the two  icons until the outer ring burner is lit. **Note:** All electronic ignitors will click at the same time. However, only the burner you are turning on will ignite.
3. Visually check that the burner has lit.
4. **Turn** the control knob to the desired flame size. The control knobs do not have to be set at a particular mark. Use the guides and adjust the flame as needed. **DO NOT** cook with the Surface Control knob in the  position. (The electronic ignitor will continue to click if left in the  position, causing premature wear.)

In the event of an electrical power outage, the surface burners can be lit manually. To light a surface burner, hold a lit match to the burner head, then slowly turn the Surface Control knob to . Use caution when lighting surface burners manually.



Regular burner control knob

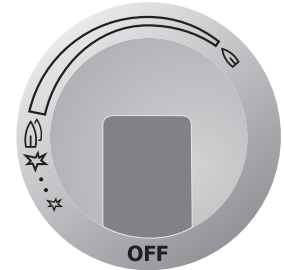

Dual burner control knob

CAUTION

Do not place plastic items such as salt and pepper shakers, spoon holders or plastic wrappings on top of the cooktop when it is in use. These items could melt or ignite. Potholders, towels or wood spoons could catch fire if placed too close to a flame.

Using the griddle

The griddle is intended for direct food cooking and can be used on both sides. **Do not** use pans or other cookware on the griddle. Doing so could damage the finish. With the grate in position over the burner, set the griddle on top of the grate positioning the notches in the griddle over the grate fingers (refer to figures 1 for optimal positioning).

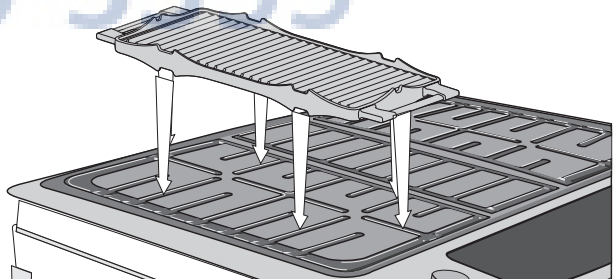

Figure 1

CAUTION

Always place the griddle on the grate before lighting the burner.

Always use potholders to remove the griddle from the grate. Allow the griddle to cool before removing. Do not set hot griddle on surfaces that cannot withstand high heat; such as countertops.

Be sure the griddle is positioned correctly and stable before use to prevent hot spills and possible burns.

Lower oven operation

The lower oven provides two basic modes, cooking and warming. The lower oven is ideal for cooking foods such as pizza, casseroles, baked potatoes and frozen convenience foods. Use the keep warm feature to keep hot cooked foods at serving temperature. The lower oven can only be used with some cooking modes; Bake, Slow Cook and Keep Warm (read their sections for precise instructions).

WARNING

Keep children away from the lower oven when hot. Failure to do so can result in burns.

CAUTION

Always use oven mitts when removing food from the lower oven. The lower oven rack, compartment, cookware/plates may be hot.

Lower Oven Tips:

- The lower oven rack must always be in place when cooking or warming. Be sure that the rack is placed with the down turned sides into the drawer. This will provide for some air space between the drawer and the food.
- When placing food in the lower oven always use a baking sheet or pan with 4 raised sides to prevent food from sliding off.
- **DO NOT LINE THE OVEN DRAWER WITH FOIL OR COVER THE OVEN RACK WITH FOIL.** This may result in damage to your oven.
- The maximum height of foods and utensils that may be used in the lower oven is 4". The maximum width is 15". **Pay close attention to foods that have potential to rise beyond the recommended 4" maximum height.**
- Use pans in the lower oven large enough to contain food and any juices created from the cooking process.

- **Do not use plastic wrap to cover food. Plastic may melt onto the drawer or surrounding areas and be very difficult to clean.** Use a lid or aluminum foil instead. Use only utensils and cookware in the oven drawer that are recommended for oven use in the upper oven.
- When using the lower oven, limit the number of times the drawer is opened; this will minimize heat loss. Repeated opening of the drawer during the cooking process may increase cooking times and produce uneven cooking results. The cooking times for the lower oven may vary slightly from the upper oven.

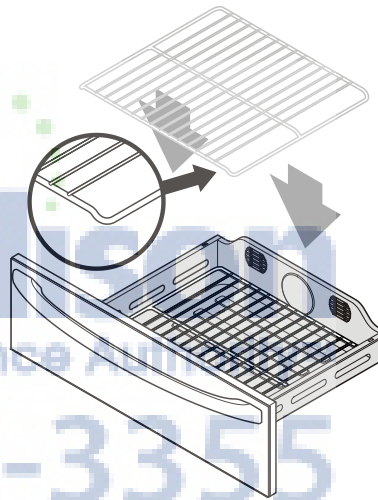

NOTE: The lower oven will not operate when the upper oven is set for self-cleaning or if the control lockout feature is active.

WARNING

Should an oven fire occur, close the drawer and turn the lower oven OFF. If the fire continues, use a fire extinguisher. **DO NOT** put water or flour on the fire. Flour may be explosive.

18 Setting Oven Controls

About rapid preheat

Use the rapid preheat option on **single rack baking** to quickly bring the oven to baking temperature.

The rapid preheat option may be set with the following cooking features:





- Bake
- Conv bake

The following temperature settings apply to the rapid preheat feature:

- Auto-suggest (default) setting: **350°F/176°C**
- Min. rapid preheat setting: **170°F / 76°C**
- Max. rapid preheat setting: **550°F / 288°C**

Setting rapid preheat

See example below to set a rapid preheat with bake to start immediately using default temperature.

Step	Example	Press
1.	Press UPPER OVEN	
2.	Press BAKE	
3.	Press COOK OPTIONS	
4.	Press RAPID PREHEAT	
5.	Press START	

When START is pressed the oven will preheat quickly. The control will display PRE-HEATING during this time. While PREHEATING the Convection fan may operate.

After a few minutes a beep will sound and PRE-HEATING will no longer display. Place prepared food on a single oven rack. The oven will continue to bake at the set temperature until bake is canceled.

NOTE

You may press CANCEL at any time when setting the control or during the cooking process.

To add or change any cook settings after this feature has started:

- Select the **UPPER** oven. Make temperature changes using the + or - keys. Each press of + or - will adjust the temperature by 5° F (or 2°C).
- If changing cooking times, select the **cook time** or **end time** keys needed to make the changes.



For best results

- **Single oven rack cooking ONLY.**
- Use in oven rack positions 2 or 3.

About baking in oven

Use the bake feature to cook most food items that require normal cooking temperatures.

Bake may be set with the following options:



- Rapid preheat
- Cook time
- Cook time with end time
- Probe

The following temperature settings apply to the bake feature:

- Auto-suggest (default) setting: **350°F/176°C**
- Min. bake setting: **170°F / 76°C**
- Max. bake setting: **550°F / 288°C**

Setting bake for oven

See example below to set a bake to start immediately using the default temperature.

Example	
Step	Press
1. Select the oven by pressing UPPER or LOWER OVEN	
2. Press BAKE	
3. Press START	

Once START is pressed the oven will begin heating. The oven display shows PRE-HEATING. While PREHEATING the Convection fan may operate.

After the oven reaches set temperature, PRE-HEATING will turn off and a beep will indicate the oven is ready. The oven will continue to maintain this temperature until the cooking feature is canceled.

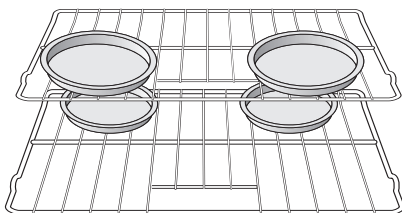

NOTE

You may press CANCEL at any time when setting the control or during the cooking process.

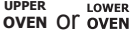

Pan position for two rack baking.

If your recipe requires a different baking temperature than the auto-suggested (default) temperature (example below shows lower oven temperature set for 425°F/ 218°C) :

Example	
Step	Press
1. Select the oven by pressing UPPER or LOWER OVEN	
2. Press BAKE	
3. Enter 425°F	425
4. Press START	

To add or change any cook settings after this feature has started:

- Select the **UPPER or LOWER OVEN**. Make temperature changes using the + or - keys. Each press of + or - will adjust the temperature by 5° F (or 2°C).
- If changing cooking times, select the **cook time** or **end time** keys needed to make the changes.



For best results

- Use only one rack at position 5 and center the pans as much as possible.
- If using two racks, place the oven racks in position 3 and 7.
- When placing multiple food items in the oven allow 2-4" (5-10cm) of space between the food items for proper air circulation (see figures for more details).
- Dark or dull pans absorb more heat than shiny bakeware resulting in dark or overbrowning of foods. It may be necessary to reduce the oven temperature or cook time to prevent overbrowning of some foods. Dark pans are recommended for pies. Shiny pans are recommended for cakes, cookies and muffins.

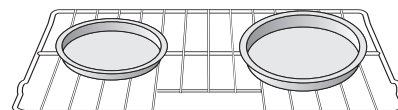

Pan position for one rack baking.

Using cook time

Adding a cook time when baking is beneficial when a recipe requires a specific temperature and period of time to cook. Following the recipe cook time helps insure the best possible results.

Cook time may be set with the following features:

- Bake
- Conv bake
- Conv roast
- Slow cook
- Defrost
- Dehydrate
- Bread proof
- Keep warm
- Perfect turkey



NOTE

You may press CANCEL at any time when setting the control or during the cooking process.

See example below to set the oven for bake, starting immediately with preheating to the auto-suggest (default) setting of 350°F (176°C) and then to automatically turn off after 30 minutes:

Example	
Step	Press
Preheat the oven if necessary	
1. Press UPPER OVEN	
2. Press BAKE	
3. Press START	
4. Press COOK OPTIONS	
5. Press COOK TIME	
6. Enter 30 minutes	30
7. Press START	

Once START is pressed the oven will cook and after 30 minutes automatically shut-off.

AjMadison
Your Appliance Authority™
800-570-3355

Using cook time with end time

Adding a cook time along with a specific end time gives the same benefits as the cook time option in addition to controlling exactly when the cooking process will begin and end.

Cook time and end time may be set with the following features:

- Bake
- Convection bake
- Convection roast
- Slow cook
- Clean (delayed Clean uses end time only)
- Defrost
- Dehydrate
- Bread proof
- Keep warm

See example below to set the lower oven with preheating for bake at 375°F (176°C) for 50 minutes and to automatically shut-off at 5:30:

Example	
Step	Press
1. Press UPPER OVEN	UPPER OVEN
2. Press BAKE	
3. Enter 375°F	375
4. Press COOK OPTIONS	
5. Press COOK TIME	
6. Enter 50 minutes	50
7. Press START	
8. Press END TIME	
9. Enter 5:30	530
10. Press START	

NOTE

- When setting the **END TIME** option be sure the correct time of day is set.
- You may press **CANCEL** any time when setting the control or during the cooking process.
- You may also choose to use **COOK TIME** with no **END TIME**.

Once **START** is pressed, the oven will calculate the start time at which the oven will begin heating.

The oven will continue to maintain this temperature for the selected time or until the cooking feature is canceled.

CAUTION

Use caution with the **COOK TIME** or **END TIME** features. Use the automatic timer when cooking cured or frozen meats and most fruits and vegetables. Foods that can easily spoil such as milk, eggs, fish, meat or poultry, should be chilled in the refrigerator first. Even when chilled, they should not stand in the oven for more than 1 hour before cooking begins, and should be removed promptly when cooking is completed. Eating spoiled food can result in sickness from food poisoning

Broiling in oven

Use the **broil** feature to cook meats that require direct exposure to radiant heat for optimum browning results.

Use the **conv broil** feature to cook thicker cuts of meats that require direct exposure to radiant heat and the convection fan for optimum browning results.

The following temperature settings apply to the broil feature:

- Auto-suggest (default) setting: **550°F / 288°C**
- Min. broil setting: **300°F / 148°C**
- Max. broil setting: **550°F / 288°C**

WARNING

Should an oven fire occur, close the oven door. If the fire continues, throw baking soda on the fire or use a fire extinguisher. **Do not** put water or flour on the fire. Flour may be explosive and water can cause a grease fire to spread and cause personal injury.

CAUTION

- **Do not** use the broiler pan without the insert.
- **Do not** cover the broil pan/insert with aluminum foil; the exposed grease could ignite.
- To prevent food from contacting the broil element and to prevent grease splattering, **do not** use the roasting rack when broiling.





For best results

- Use the recommended pans and oven rack positions for the type of meat being prepared -Figs. 1 & 2-.
- For optimum browning results, allow the oven to preheat **5-6 minutes** before placing the food in the oven.

Setting broil

See example below to set broil for the oven starting immediately with the auto-suggest (default) setting:

Example	
Step	Press
1. Place the broiler insert on the broiler pan, then place the meat on the insert. Remember to follow all warnings and cautions.	
2. Arrange the interior oven rack to rack position recommendations -Figs. 2 & 3-. Be sure to place the prepared food and pan directly under broil element. Leave the oven door closed.	
3. Press UPPER OVEN	
4. Press BROIL	
5. Press START	

NOTE

You may press **CANCEL** at any time when setting the control or during the cooking process.

To add or change any cook settings after this feature has started:

- Wake control panel from the sleep mode if necessary.
- Select the **UPPER**. Make temperature changes using the **+** or **-** keys. Each press of **+** or **-** will adjust the temperature by 5°F (or 2°C).

Setting broil

The broil pan insert (if equipped) contains slots that allows grease from the meat to drain into the broil pan. Place prepared meat on broil pan insert and then place onto broiler pan as shown -Fig. 1-.

Recommended broiling times

Use the broiling table -Fig. 3- for approximate recommended broiling times for the types of meats listed. Increase or decrease broiling times, or move the broiling pan to a different rack position to suit for doneness.

If the food you are broiling is not listed in the table, follow the instructions provided in your recipe and watch the item closely.

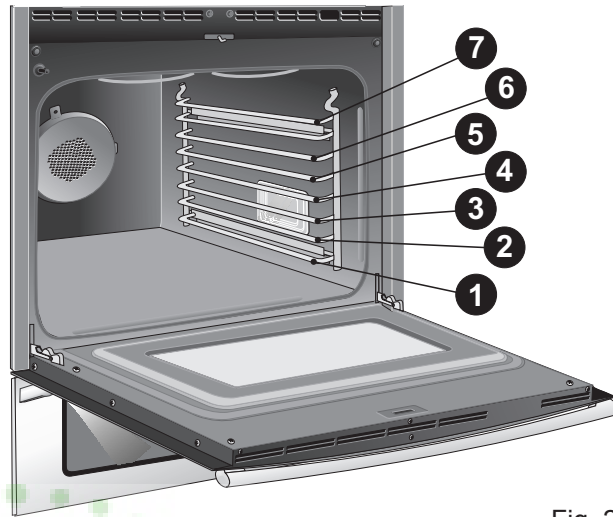

Fig. 2

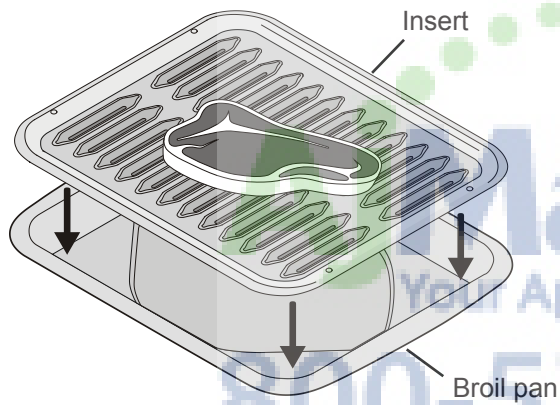

Fig. 1

Madison
 Your Appliance Authority™
 800-570-3355

Broiling Table					
Food	Rack position	Temp	Cook time in minutes		Doneness
			1st side	2nd side	
Steak 1" thick	7th	550°F	6	4	Rare
	7th	550°F	7	5	Medium
	7th	550°F	8	7	Well
Pork chops 3/4" thick	7th	550°F	8	6	Well
Chicken-bone in	5th	450°F	20	10	Well
Chicken-boneless	7th	450°F	8	6	Well
Fish	7th	500°F	13	0	Well
Shrimp	5th	550°F	5	0	Well
Hamburger 1" thick	7th	550°F	9	7	Medium
	5th	550°F	10	8	Well

Fig. 3

About convection bake

Convection bake is part of the Perfect-Convect³™ system. Convection bake uses a fan to circulate the oven heat evenly and continuously. The improved heat distribution allows for even cooking with excellent results. Multiple rack cooking may slightly increase cook times for some foods, but the overall result is time saved.

The conv bake feature should **ONLY** be used when your recipe instructions have been written for use with convection baking.

If your recipe instructions are for normal baking and you wish to use convection bake, follow the **Convection Convert** option instructions. The convection convert option will automatically adjust the oven temperature so that convection baking may provide the best possible results.

Conv bake may be set with the following options:

- Conv convert
- Cook time or cook time with end time
- Probe
- Rapid preheat

Benefits of convection bake:

- Superior multiple oven rack performance.
- Some foods cook up 25 to 30% faster, saving time and energy.
- No special pans or bakeware required.

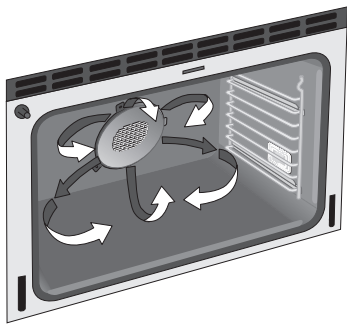



Setting convection bake

The following temperature settings apply to the conv bake feature:

- Auto-suggest (default) setting: **350°F/176°C**
- Min. bake setting : **170°F / 76°C**
- Max. bake setting: **550°F / 288°C**

See the example below to set conv bake, starting immediately with the auto-suggest (default) setting of 350°F (176°C):

Example	
Step	Press
1. Press UPPER OVEN	UPPER OVEN
2. Press CONV BAKE	
3. Press START	

Once **START** is pressed the oven will begin heating. The oven display shows **PRE-HEATING** during this time.

After the oven reaches set temperature, **PRE-HEATING** will turn off and a beep will indicate the oven is ready. The oven will continue to maintain this temperature until the cooking feature is canceled.



For best results

- When baking with a single rack use rack positions 5. When using 2 racks use rack positions 3 & 7. When using 3 racks use rack positions 2, 5 & 8.
- Cookies and biscuits should be baked on pans with no sides or very low side to allow heated air to circulate around the food.
- Food baked on pans with a dark finish will cook faster.
- When placing multiple food items in the oven allow 2-4" (5-10cm) of space between the food items for proper air circulation.

NOTE

You may press **CANCEL** at any time when setting the control or during the cooking process.

Using convection convert

The conv convert option allows you to convert any normal baking recipe using the convection bake feature. The control uses the normal recipe settings and adjusts to a lower temperature for convection baking. Conv convert must be used with CONV BAKE feature.

Benefits of conv bake using conv convert option:

- Superior multiple oven rack performance.
- Some foods cook up 25 to 30% faster, saving time and energy.
- No special pans or bakeware required.



For best results

- When baking with a single rack use rack positions 5. When using 2 racks use rack positions 3 & 7. When using 3 racks use rack positions 2, 5 & 8.
- Cookies and biscuits should be baked on pans with no sides or very low side to allow heated air to circulate around the food.
- Food baked on pans with a dark finish will cook faster.
- When placing multiple food items in the oven allow 2-4" (5-10cm) of space between the food items for proper air circulation.



NOTE

You may press CANCEL at any time when setting the control or during the cooking process.

Setting convection convert

See the example below to set conv bake, starting immediately with the auto-suggest (default) setting of 350°F (176°C) and adding the conv convert option.

Example	
Step	Press
1. Press UPPER OVEN	
2. Press CONV BAKE	
3. Press COOK OPTIONS	
4. Press CONV CONVERT	
5. Press START	

Once **START** is pressed the oven display shows **PRE-HEATING**. After the oven reaches the converted set temperature, **PRE-HEATING** will turn off and a beep will indicate the oven is ready.

The added conv convert option will automatically **lower** the set temperature you set from the bake recipe to an adjusted conv bake temperature.

When conv convert is used with cook time, "**CF**" (Check Food) will display when the cook time is 75% complete. The control will also beep at regular intervals until baking has finished.

To add or change any cook settings after this feature has started:

- Select the **UPPER** oven. Make temperature changes using the + or - keys. Each press of + or - will adjust the temperature by 5° F (or 2°C).
- If changing cooking times, select the **cook time** or **end time** keys needed to make the changes.

About convection roast

How convection roast works

Convection roast is part of the Perfect-Cook³™ system. Convection roast combines a cook cycle with the convection fan and element to rapidly roast meats and poultry. Heated air circulates around the meat from all sides, sealing in juices and flavors. Meats cooked with this feature are crispy brown on the outside while staying moist on the inside. In addition, there is no need to reduce the oven temperature when using convection roast.

Convection roast may be set with the following options:

- Probe
- Cook time or cook time with end time

The following temperature settings apply to convection roast:

- Factory auto-start default: **350°F/176°C**
- Minimum: **170°F/ 76°C**
- Maximum: **550°F/ 288°C**

Benefits of convection roast:

- Superior multiple oven rack performance.
- Some foods cook up 25 to 30% faster, saving time and energy.
- No special pans or bakeware required.





For best results

- Preheating is not necessary for most meats and poultry.
- Place food items using the recommended rack positions for the type of food being prepared.
- When placing multiple food items in the oven allow 2-4" (5-10cm) of space between the food items for proper air circulation.
- Be sure to carefully follow your recipe's temperature and time recommendations or refer to the convection roast chart for additional information -p. 27, Fig. 2-

Setting convection roast

See example below to set convection roast to start immediately with the auto-suggest (default) setting:

Example	
Step	Press
1. Press UPPER OVEN	
2. Press CONV ROAST	
3. Press START	

Once START is pressed the oven will begin heating.



NOTE

You may press CANCEL at any time when setting the control or during the cooking process.

To add or change any cook settings after this feature has started:

- Select the **UPPER** oven. Make temperature changes using the **+** or **-** keys. Each press of **+** or **-** will adjust the temperature by 5° F (or 2°C).
- If changing cooking times, select the **cook time** or **end time** keys needed to make the changes.

Roasting recommendations

Roasting rack instructions

When preparing meats for convection roasting, you may use the broiler pan, insert and the roasting rack supplied with your appliance. The broiler pan will catch grease spills and the insert will help prevent grease splatters. The roasting rack fits on top of the insert allowing the heated air to circulate under the food for even cooking and helps to increase browning on the underside.

1. Place oven rack on bottom or next to the bottom oven rack position.
2. Place the insert on the broiler pan.
3. Make sure the roasting rack is securely seated on top of the insert. **Do not** use the broiler pan without the insert. **Do not** cover the insert with aluminum foil.
4. Position food (fat side up) on the roasting rack.
-Fig. 1-
5. Place prepared food on oven rack in the oven.

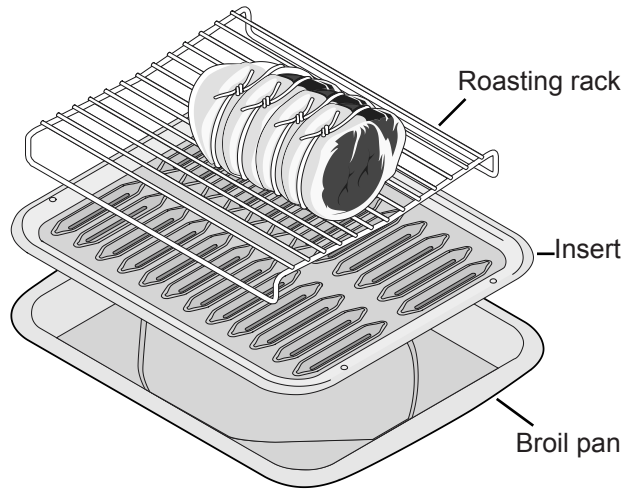

Fig. 1

Convection Roasting Chart					
Meat		Weight	Oven temp	Internal temp	Minute per lb.
Beef	Standing rib roast	4 to 6 lbs.	350°F	*	25-30
	Rib eye roast	4 to 6 lbs.	350°F	*	25-30
	Tenderloin roast	2 to 3 lbs.	400°F	*	15-25
Poultry	Turkey, whole**	12 to 16 lbs.	325°F	180°F	8-10
	Turkey, whole**	16 to 20 lbs.	325°F	180°F	10-15
	Turkey, whole**	20 to 24 lbs.	325°F	180°F	12-16
	Chicken	3 to 4 lbs.	350°F - 375°F	180°F	12-16
Pork	Ham roast, fresh	4 to 6 lbs.	325°F	160°F	30-40
	Shoulder blade roast	4 to 6 lbs.	325°F	160°F	20-30
	Loin	3 to 4 lbs.	325°F	160°F	20-25
	Pre-cooked ham	5 to 7 lbs.	325°F	160°F	30-40

Fig. 2

* For beef: med rare 145°F, med 160°F, well done 170°F

** Stuffed turkey requires additional roasting time. Shield legs and breast with foil to prevent overbrowning and drying of the skin.

About convection broiling

Convection broiling is part of the Perfect-Convect³™ system. Use the conv broil feature to cook thicker cuts of meats that require direct exposure to radiant heat and the convection fan for optimum browning results. This cooking feature is only available for the upper oven.

The following temperature settings apply to the conv broil feature:

- Auto-suggest (default) setting: **550°F/ 288°C**
- Min. convection broil setting: **300°F/ 148°C**
- Max. convection broil setting: **550°F/ 288°C**

WARNING

Should an oven fire occur, leave the oven door closed and turn the oven OFF. If the fire continues, throw baking soda on the fire or use a fire extinguisher. **Do not** put water or flour on the fire. Flour may be explosive and water can cause a grease fire to spread and cause personal injury.

CAUTION

- **Do not** use the broiler pan without the insert. **Do not** cover the broil pan or insert with aluminum foil; the exposed grease could ignite.
- To prevent food from contacting the broil element and to prevent grease splattering, **do not** use the roasting rack when broiling.





For best results

- Use the recommended pans and rack positions. *-refer to setting broil section-*
- For optimum results preheat oven for 5-6 minutes.

Setting convection broil

See example below to set conv broil for the lower oven to start immediately with the auto-suggest (default) setting.

Example	
Step	Press
1. Place the broiler insert on the broiler pan, then place the meat on the insert. Remember to follow all warnings and cautions.	
2. Arrange the interior oven rack <i>-refer to setting broil section-</i> for position recommendations. Be sure to place the prepared food and pan directly under broil element. Close the oven door.	
3. Press UPPER OVEN	
4. Press CONV BROIL	
5. Press START	

NOTE

You may press CANCEL any time when setting the control or during the cooking process.

To add or change any cook settings after this feature has started:

- Select the **UPPER** oven. Make temperature changes using the + or - keys. Each press of + or - will adjust the temperature by 5° F (or 2°C).

About the probe function

Checking the internal temperature of your food is the most effective way of insuring that your food has been properly cooked. When cooking meat such as roasts, hams or poultry you can use the probe to check the internal temperature without any guesswork.

Your oven will automatically change from cooking to keep warm once the probe has reached the set temperature.

The following temperature settings apply to the probe function:

- Default: **170°F/76°C**
- Minimum: **130°F / 54°C**
- Maximum: **210°F / 98°C**

Setting the probe

Proper probe placement

- Always insert the probe so that the tip rests in the center of the thickest part of the meat. Do not allow the probe to touch bone, fat, gristle or the pan.
- For bone-in ham or lamb, insert the probe into the center of the lowest large muscle or joint. For dishes such as meat loaf or casseroles, insert the probe into the center of the food. To find the center of the food visually measure with the probe -*Fig. 3-*. When cooking fish, insert the probe just above the gill.
- For whole poultry or turkey, insert the probe into the thickest part of the inner thigh, below the leg -*Fig. 1-*.

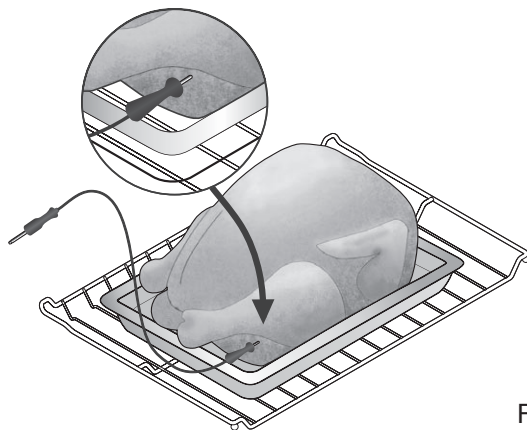

Fig. 1

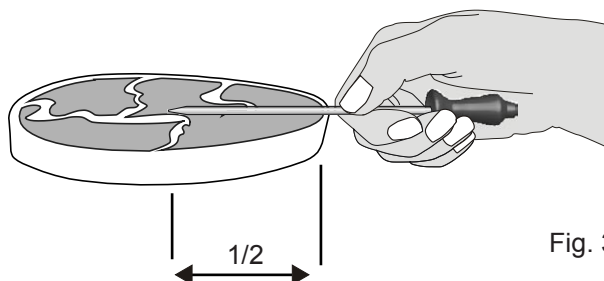

Fig. 3

→ IMPORTANT

- Use only the probe supplied with your appliance; any other may result in damage to the probe or the appliance.
- Be sure the probe is **fully** inserted into the probe receptacle. The probe will not work properly until correctly connected - *Fig. 2.*
- Handle the probe carefully when inserting and removing it from the food and the receptacle.
- Do not use tongs to pull the cable when inserting or removing it from the food or the receptacle.
- Defrost your food completely before inserting the probe to avoid damaging probe.
- **Never leave or store the probe inside the oven when not in use.**
- To prevent the possibility of burns, carefully unplug the probe using a pot holder.

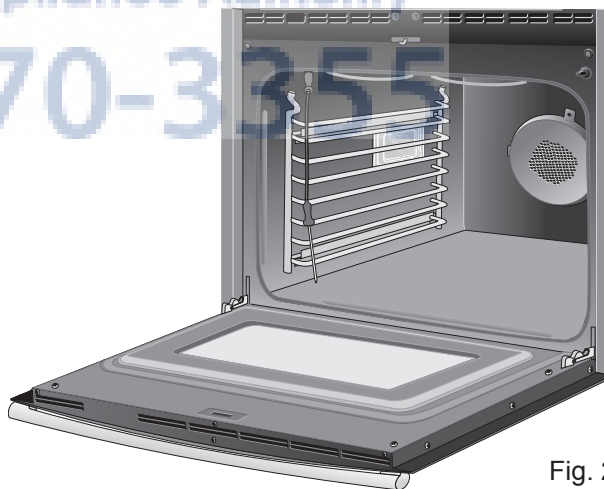



Fig. 2

Setting the probe

See the example below to set the probe target temperature to 180°F/82°C when using the convection roast feature with oven set temperature for 325°F/162°C.

Example	
Step	Press
1. Insert the probe into the food and place the food into the oven -Fig. 1-.	
2. Plug the probe COMPLETELY into the probe receptacle inside the oven -Fig. 2- and close the oven door.	
3. Press UPPER OVEN	
4. Press CONV ROAST	
5. Enter 325	
6. Press START	
7. Press PROBE two times.	
8. Enter 180	
9. Press START	

* You may skip steps 7-9 if you choose to use the default internal target temperature of 170°F for the probe.

By the default, your oven will adjust to the **keep warm** setting once the probe has reached the set temperature.

NOTE

- When the meat probe is connected to the receptacle and a cooking function is started, the display will show the current temperature reported by the meat probe.
- Any time during the cooking process you may press  to see or modify the target temperature.

About keep warm

Use the keep warm feature to keep hot foods warm. Keep warm may be set with the following options:

- Cook time
- Cook time with end time

The following temperature settings apply to the keep warm feature:

- Auto-suggest (default) setting: **170°F / 76°C**
- Min. keep warm setting: **150°F / 66°C**
- Max. keep warm setting: **190°F / 88°C**

WARNING



- FOOD POISONING HAZARD. Do not let food sit for more than one hour before or after cooking. Doing so may cause bacteria to grow which can result in food poisoning or sickness.**

NOTE

You may press CANCEL at any time when setting the control or during the cooking process.

Setting keep warm

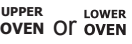
See example below to set keep warm for the oven to start immediately with the auto-suggest (default) setting.

Example	
Step	Press
1. Select the oven by pressing UPPER or LOWER OVEN	
2. Press KEEP WARM	
3. Press START	

To add or change any cook settings after this feature has started:

- Select the **UPPER** or **LOWER** oven. Make temperature changes using the + or - keys. Each press of + or - will adjust the temperature by 5° F (or 2°C).

About slow cook

The slow cook feature may be used to cook foods more slowly at lower oven temperatures. The cooking results will be like that of a Slow Cooker or Crock-Pot. This feature is ideal for roasting beef, pork & poultry. Slow cooking meats may result in the exterior of meats becoming dark but not burnt; this is normal.

Slow cook may be set with the following options:

- Cook time
- Cook time with end time

The following temperature settings apply to the slow cook feature:

- Hi: 275°F / 134°C (default) for cooking 4 to 5 hours
- Lo: 225°F / 108°C for cooking 8 to 9 hours



For best results

- Completely thaw all frozen foods before cooking.
- Position multiple racks to accommodate size of cooking utensils when cooking multiple food item.
- Add any cream or cheese sauces during the last hour of cooking.
- Do not open the oven door often or leave the door open when checking foods. The more heat that is lost, the longer the food will need to cook.
- Cover the foods to keep them moist or use a loose or vented type cover to allow foods to turn crisp or brown.
- Roasts may be left uncovered so browning can occur. Cook times will vary depending on the weight, fat content, bone & the shape of the roast.
- Preheating the oven will not be necessary.

Setting slow cook

See the example below to set a slow cook on Lo.

Example	
Step	Press
1. Select the oven by pressing UPPER or LOWER OVEN	
2. Press SLOW COOK	
3. Press -lo to choose the Lo option <i>-Fig. 2-.*</i>	
4. Press START	

*Press **+hi** to choose the Hi option *-Fig. 1-.*



Fig.1



Fig. 2

NOTE

You may press CANCEL at any time when setting the control or during the cooking process.

To add or change any cook settings after this feature has started:

- Select the **UPPER** oven. Toggle between the high and low settings by using the **+** or **-** keys.
- If changing cooking times, select the **cook time** or **end time** keys needed to make the changes.

32 Setting Oven Controls

About Perfect Turkey™

Heated air circulates around the turkey from all sides, sealing in juices and flavors. Poultry cooked with this feature are crispy brown on the outside while staying moist on the inside.

Perfect turkey combines a cook cycle with the convection fan. The probe is used to monitor the exact internal temperature of the turkey while cooking. Once the turkey has reached the set temperature, the oven will stop cooking and change to keep warm.



Before setting the perfect turkey feature, or if you would like to change the probe target temperature, be sure to carefully read and follow **setting the probe** instructions.

NOTE

- You may press CANCEL any time when setting the control or during the cooking process.
- When the meat probe is connected to the receptacle and perfect turkey is started, the display will show the current temperature reported by the meat probe.
- Any time during the cooking process you may press  to see or modify the target temperature.
- It is not recommended to modify the perfect turkey settings once cooking has started. Doing so may not provide the best results.

Setting Perfect Turkey™

See the example below to use perfect turkey at the default setting of 325°F and the probe at the default setting of 180°F (82°C).

Example	
Step	Press
1. Insert the probe into the thickest part of the meat and place the turkey in the oven -see <i>setting the probe section</i> -	
2. Plug the probe into the probe receptacle inside the lower oven.	
3. Press UPPER OVEN	UPPER OVEN
4. Press PERFECT TURKEY Probe indicator will flash and Perfect Turkey will not start until the probe has been plugged in.	
5. Press START	

Perfect Turkey Chart

Meat	Weight	Oven temp	Internal temp	Minute per lb.	
Poultry	Turkey, whole**	12 to 16 lbs.	325°F	180°F	8-10
	Turkey, whole**	16 to 20 lbs.	325°F	180°F	10-15
	Turkey, whole**	20 to 24 lbs.	325°F	180°F	12-16
	Chicken	3 to 4 lbs.	350°F - 375°F	180°F	12-16

* Stuffed turkey requires additional roasting time. Shield legs and breast with foil to prevent overbrowning and drying of the skin.

About defrost

Use the defrost feature to thaw small portions of delicate items such as cream cakes, frozen cream pies and cheesecake at room temperature. While in the defrost mode, the convection fan will operate to circulate room temperature air around the food slowly, accelerating the natural defrosting of the food without using heat.

Defrost may be set with the following options:

- Cook time
- Cook time with end time

Setting defrost

See the example below to set defrost.

Example	
Step	Press
1. Place food in oven and press UPPER OVEN	
2. Press DEFROST	
3. Press START	

NOTE

- You may press CANCEL any time when setting the control or during the cooking process.
- This feature is not meant for thawing frozen meats, poultry, seafood or other foods that need to be cooked before serving. Follow USDA recommendations for thawing foods. Only frozen foods that can be defrosted and served without cooking should be used with this feature.

About dehydrate

The dehydrate feature dries with heat from the elements. The heat is circulated throughout the oven by the convection fan. Use dehydrate to dry and/or preserve foods such as fruits, vegetables, herbs and very thin slices of meat. The Convection fan may operate while dehydrating.

The following temperature settings apply to the dehydrate feature:



- Auto-suggest (default) setting: **120°F / 48°C**
- Min. dehydrate setting: **100°F / 38°C**
- Max. dehydrate setting: **225°F / 108°C**

Dehydrate may be set with the following options:

- Cook time
- Cook time with end time

Setting dehydrate

See the example below to set dehydrate at the default temperature of 120°F.

Example	
Step	Press
1. Press UPPER OVEN	
2. Press DEHYDRATE	
3. Press START	

To add or change any cook settings after this feature has started:

- Select the **UPPER** oven. Make temperature changes using the + or - keys. Each press of + or - will adjust the temperature by 5°F (or 2°C).
- If changing cooking times, select the **cook time** or **end time** keys needed to make the changes.

Setting dehydrate (continued)



For best results

- Dry most fruits and vegetables at 140°F. Dry herbs at 100°F.
- Drying times vary depending on the moisture and sugar content of the food, the size of the pieces, the amount being dried and the humidity in the air.
- Treat fruits with antioxidants to avoid discoloration.
- Tightly woven cooling racks can be used to allow the air to circulate around the food; or use drying racks to allow the air to circulate around the food (this type of oven rack is not supplied with this appliance).
- Consult a food preservation book or library for information.

About bread proof

The bread proof feature maintains a warm environment useful for rising yeast-leavened products.

The following temperature settings apply to the bread proof feature:



- Auto-suggest (default) setting: **100°F/38°C**
- Min. bread proof setting: **85°F/30°C**
- Max. bread proof setting: **100°F / 38°C**

Bread proof may be set with the following options:

- Cook time
- Cook time with end time

Setting bread proof

See example below to set bread proof for 85°F / 30°C.

Example	
Step	Press
1. Press UPPER OVEN	
2. Press BREAD PROOF	
3. Enter 85 .	85
4. Press START	



NOTE

You may press CANCEL at any time when setting the control or during the cooking process.

To add or change any cook settings after this feature has started:

- Select the **UPPER** oven. Make temperature changes using the **+** or **-** keys. Each press of **+** or **-** will adjust the temperature by 5°F (or 2°C).
- If changing cooking times, select the **cook time** or **end time** keys needed to make the changes.



For best results

- Lightly cover the dough
- Place a bowl of hot water on the rack below.
- Use the oven light to check progress. Do not open the oven door.





About my favorite

You may store up to 3 of your most frequently used heat settings and cooking times, for the upper oven. These keys will light in the display when they are available for setting or recalling.

Each key will allow you to store a cooking feature, oven set temperature and a cook time, for the upper oven.

Saving my favorite instructions

The example below shows how to save a favorite cooking instruction.

Example	
Step	Press
1. Press UPPER OVEN	
2. Input the cooking instructions using the control keypads and any additional options you wish to save and later recall.	
3. Press START	
4. Press and hold the available MY FAVORITE for 3 seconds.	
5. Press CANCEL/off*	

You will hear a beep and a red light will display above the selected favorite to indicate that your favorite recipe has been stored.

*If you wish to store the cooking instructions but not start the oven.

Recalling a favorite



The example below shows how to recall a favorite cooking instruction.

Example	
Step	Press
1. Press UPPER OVEN	
2. Choose MY FAVORITE	
3. Press START	

Deleting a favorite

You need to delete a favorite before saving another. Choose one of the favorite keys you no longer wish to keep and store the new cooking instructions using the deleting instructions.

The example below shows how to delete a favorite cooking instruction.

Example	
Step	Press
1. Press UPPER OVEN	
2. Press and hold the available MY FAVORITE for 3 seconds. The favorite key will disappear from the control panel.	

36 Setting Oven Controls

Perfect Program™ multi stage





Multi stage will allow you to program up to 3 stages of cooking. Each stage may be programmed with a cooking feature, set temperature and a cook time. Multi stage is ideal when you want to add a keep warm after a cooking function.





The following functions may be set with multi stage:

- Bake/conv bake
- Broil/conv broil (10 minutes max.)
- Conv roast
- Keep warm

Setting multi stage

See the example to program a multi stage feature for a casserole. For stage 1, bake at 400°F for 1 hr. For stage 2, to brown, broil for at 500°F for 4 minutes.









Example for 2 stages	
Step	Press
— Stage 2 —	
8. Press BROIL	
9. Enter 500°F	500
10. Press START	
11. Enter 4 minutes	4
12. Press START/enter a total of 2 times to program only 2 stages and begin cooking.	 



Example for 2 stages	
Step	Press
1. Press UPPER OVEN	
2. Press MULTI STAGE	1 2 3
— Stage 1 —	
3. Press BAKE	
4. Enter 400°F	400
5. Press START	
6. Enter 60 minutes	60
7. Press START	

AJMadison
 Your Appliance Authority™
 800-570-3355

Setting multi stage

See the example to program a multi stage feature for a casserole. For stage 1, bake at 350°F for 1 hr. For stage 2, to brown, broil for at 500°F for 4 minutes. For stage 3, keep warm for 15 minutes.

Example for 3 stages	
Step	Press
1. Press UPPER OVEN	
2. Press MULTI STAGE	
— Stage 1 —	
3. Press BAKE	
4. Enter 350°F	350
5. Press START	
6. Enter 60 minutes	60
7. Press START	
— Stage 2 —	
8. Press BROIL	
9. Enter 500°F	500
10. Press START	
11. Enter 4 minutes	4
12. Press START	

Example for 3 stages	
Step	Press
— Stage 3 —	
13. Press KEEP WARM	
14. Enter 170°F	170
15. Press START	
16. Enter 15 minutes	15
17. Press START	

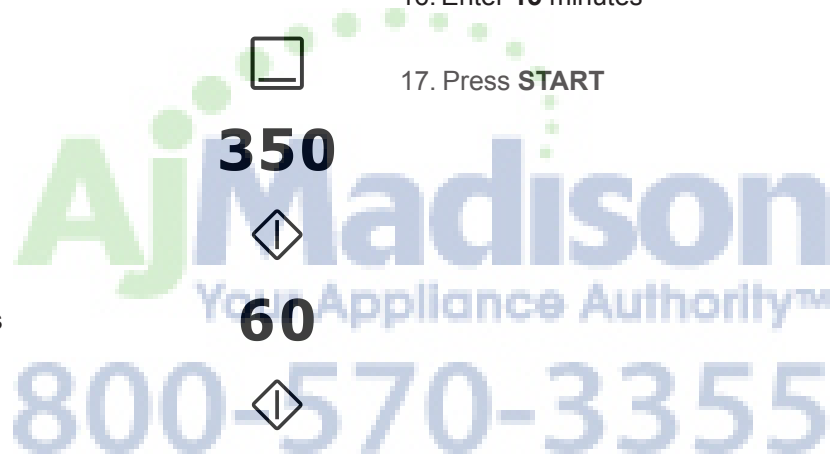

38 Setting Oven Controls

Sabbath mode

The oven of this appliance provides special settings for use when observing the Jewish Sabbath/Holidays. This mode will turn off all audible tones or visual display changes normally provided by the oven control. **BAKE** is the only cooking features available while in the Sabbath mode.

You must first set the **BAKE** feature and temperature(s) needed for the oven, the **COOK TIME** option if needed before setting the Sabbath mode. Any settings made prior to setting the Sabbath mode will be visible in the displays.

The Sabbath mode will override the factory preset 12 Hour Energy Saving mode and the appliance will stay on until the cooking features are cancelled. If any of the cooking features are cancelled when the appliance is in the Sabbath mode, no audible or visual indicators will be available to verify the cancellation.

If the oven interior lights are needed, be sure to activate them prior to setting the Sabbath mode. Once the oven light is turned ON and the Sabbath mode is active, the oven light will remain on until the Sabbath mode is turned off and the oven lights are turned off. The oven door will not activate the oven interior lights when the oven door is opened or closed.

It is recommended that any oven temperature modification made within an active Sabbath mode be followed with 2 presses of the **START** key. This will insure the oven remains ON even if an attempt is made to set the oven temperature outside of its temperature range. If the oven temperature is set outside of the temperature range, the oven will default to the nearest available temperature. Try to set the desired oven temperature again.

Should a power failure or interruption occur during the Sabbath/Holidays, the appliance will shut OFF. When power is restored the appliance will not turn back on automatically to the original BAKE feature settings. **SF** will appear in all the control display panels indicating a Sabbath mode failure. - Fig. 1- After a power failure, the food may be safely removed from the oven while still in the Sabbath mode.





Fig. 1

For further assistance, guidelines for proper usage and a complete list of models with the Sabbath feature, please visit the web at <http://www.star-k.org>.

Setting Sabbath mode

The example below shows setting the oven to observe the Sabbath (and Jewish holidays).

Example	
Step	Press
1. Press UPPER OVEN or LOWER OVEN .	UPPER OVEN OR LOWER OVEN
2. Press BAKE .	
Be sure to make any additional oven setting changes before going to step 3	
3. Press START	
4. To enter Sabbath mode, press and hold simultaneously both the LO and HI keys together for 3 seconds (a beep will sound) and release.	- + lo & hi

Once properly set in Sabbath mode, SAb -Fig. 1- will show in the oven display until the Sabbath mode is cancelled.







Fig. 1

Canceling Sabbath mode

The example below shows how to cancel the Sabbath mode.

Example	
Step	Press
1. Press and hold both the LO and HI keys together for 3 seconds (a beep will sound) and release.	- + lo & hi
2. All cooking features previously set will automatically cancel once Sabbath mode has ended.	

NOTE





The only keys available once the appliance is set for the Sabbath mode are     & .

You may change the oven temperature and any cooktop settings once baking has started (Jewish holidays only). Choose oven and press **BAKE**, use the + or - keys to set the oven temperature and press **START** twice. Each press of + or - will adjust the temperature by 5°F (or 2°C). Remember that **the oven control will no longer beep or display any further changes** once the oven is set in the Sabbath mode.

Wave-Touch™ user preferences

The  key controls options for preferences. The display will show a digital abbreviation and a value for every preference each time a key is pressed one at a time.

Please read the following instructions before changing the user preferences functions:

- Press and continue to press **USER PREF**  to navigate through the preferences.
- Press **+hi** or **-lo** to toggle between options for each preference.
- Press **+hi** or **-lo** to increase or decrease numeric values. You may also use the numeric keys to input precise values.
- Press **START**  to accept a new option entry or press **USER PREF**  to advance to the next preference.
- Press **CANCEL**  to exit the preferences mode.

Setting clock

See the example below to set the clock to 1:30.



Example	
Step	Press
1. Press USER PREF .	
2. Enter 1:30 or use +hi/-lo to advance to 1:30.	130
3. Press START to accept or press CANCEL to reject.	



Fig. 1

Setting clock display

The clock display mode allows you to turn the clock display on or off.

See the example below to change the clock display to OFF.



Example	
Step	Press
1. Press and continue to press USER PREF until you reach the preset clock display mode -Fig. 2-	
2. Use the +hi & -lo to toggle to the CLO off option -Fig. 3-	+ - hi or lo
3. Press START to accept or press CANCEL to reject.	



Fig. 2

Fig. 3

NOTE

User preference options are not available while cooking or when using the kitchen timer.

Setting 12 or 24 hour mode

The clock display mode allows you to choose between 12 and 24 hour mode. The factory preset clock display mode is 12 hour.

See the example below to change the default mode to 24 hour.



Example	
Step	Press
1. Press and continue to press USER PREF until you reach the preset clock display mode -Fig. 1-.	
2. Use the +hi & -lo to toggle to the 24hr option. -Fig. 2-.	+ - hi or lo
3. Press START to accept or press CANCEL to reject.	



Fig. 1



Fig. 2

Changing between °F or °C

Your control has the ability to display and set Fahrenheit or Celsius temperatures. The factory preset temperature display is Fahrenheit.

See the example below to change the default temperature display to Celsius.



Example	
Step	Press
1. Press and continue to press USER PREF until you reach the Fahrenheit/Celsius mode. -Fig. 1-.	
2. Use the +hi or -lo to toggle to the C option. -Fig. 2-.	+ - hi or lo
3. Press START to accept or press CANCEL to reject.	



Fig. 1





Fig. 2

42 Setting Your Preferences

Setting 12hr energy saving mode

The oven control has a factory preset built-in 12 hour energy saving feature that will shut off the appliance if the oven has been heating for more than 11 hours and 59 minutes. The oven can be programmed to override this feature for continuous baking.

See the example below to turn off 12 hour energy saving mode.

Example	
Step	Press
1. Press and continue to press USER PREF until you reach the preset 12hr energy saving mode -Fig. 1-	
2. Use the +hi & -lo to toggle to the off option -Fig. 2-	+ - hi or lo
3. Press START to accept or press CANCEL to reject.	

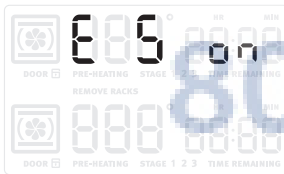

Fig. 1



Fig. 2

Setting audio mode

The audio mode allows you to control the audio for the oven control. You may turn the audio off and later return to operating with all the normal audible sounds and alerts.

See the example below when changing the audible settings.



Example	
Step	Press
1. Press and continue to press USER PREF until you reach the pre-set audio mode .	
2. Use the +hi or -lo to choose the off option -Fig. 1- or the on option -Fig. 2-	+ - hi or lo
3. Press START to accept or press CANCEL to reject.	



Fig. 1



Fig. 2

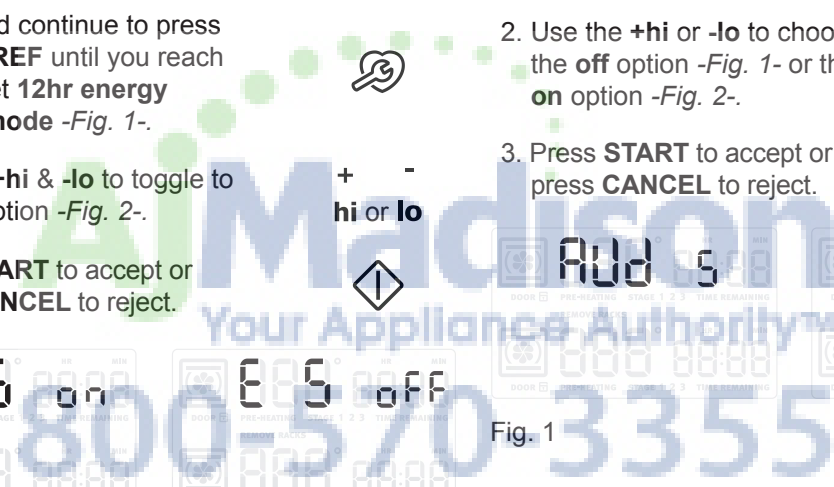



 800-570-3355

Adjusting oven temperature User preference offset

Your appliance has been factory calibrated and tested to ensure an accurate baking temperature. For the first few uses, follow your recipe times and temperature recommendations carefully.

If you feel your oven is too hot or too cool from your baking experience, the oven temperature may be adjusted to your liking. The temperature may be increased up to +35°F (+19°C) or decreased down to -35°F (-19°C) from normal.

See the example below to increase the temperature in the **upper oven**.

Example	
Step	Press
1. Press and continue to press USER PREF until you reach the user preference offset mode -Figs. 1-.	
2. Press +hi to adjust the temperature higher. -Fig. 2-	+ hi
3. Use +hi to advance to 10 -Fig. 2-.	+ hi or 10
4. Press START to accept or press CANCEL to reject.	

To set the temperature lower use the lo- key.

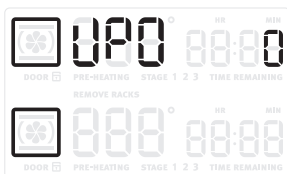

Fig. 1

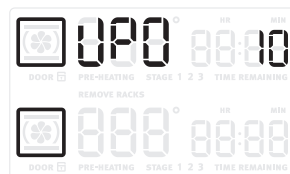

Fig. 2

Factory default reset

You may choose to restore your factory settings. **This will erase all settings or favorites that you have saved.**

See the example below reset your control.



Example	
Step	Press
1. Press and continue to press USER PREF until you reach the factory default reset mode. -Fig. 1-	
2. Use the +hi or -lo to toggle to the no -Fig. 1- or yes -Fig. 2- option to reset.	+ - hi or lo
3. Press START to accept or press CANCEL to reject.	



Fig. 1



Fig. 2

AjMadison
Your Appliance Authority
800-570-3355

Before starting self-clean

A self-cleaning oven automatically cleans with high temperatures that are well above those used for normal cooking. The self-clean feature eliminates soils completely or reduces them to a fine powdered ash that you can later easily wipe away with a damp cloth.

Adhere to the following precautions when running the self-clean cycle:

- **Do not** use oven cleaners or protective coatings in or around the oven interior.
- **Do not** clean the oven door gasket. The woven material of the oven door gasket is essential for a good seal. Care should be taken not to rub, damage or remove the gasket. -Fig. 1-
- **Do not** use any cleaning materials on the door gasket. Leaving chemical residue can damage the door gasket.
- **DO NOT** force the oven door open. The automatic door locking system can be damaged.
- **Remove** the broiler pan, insert, all utensils and any **aluminum foil**. These items cannot withstand high cleaning temperatures.
- All oven racks and supports **MUST** be removed. If they are left in while attempting to set a self-clean cycle, the display will show **REMOVE RACKS** -Fig. 2. The oven control will not start a self-clean cycle without first removing all the oven racks and supports.
- **Remove any excessive spillovers** in the oven cavity **before** starting a self-clean cycle. To clean, use hot, soapy water and a cloth. Large spillovers can cause heavy smoke or fire when subjected to high temperatures.
- Clean any soil from the oven frame, the door liner outside the oven door gasket and the small area at the front center of the oven bottom with soap and water. These areas heat sufficiently to burn soil on.
- **Do not** allow food spills with a high sugar or acid content (such as milk, tomatoes, sauerkraut, fruit juices or pie filling) to remain on the porcelain surface, they may leave a dull spot even after cleaning.

! WARNING

During the self-clean cycle, the outside of the appliance can become very hot to the touch. **DO NOT** leave small children unattended near the appliance.

! CAUTION

- **DO NOT** line the oven walls, oven racks, bottom or any other part of the range with aluminum foil. Doing so will stop heat distribution, produce poor baking results and cause permanent damage to the oven interior (aluminum foil will melt to the interior surface of the oven).
- Use caution when opening the door after the self-clean cycle is finished. The oven may still be **VERY HOT**.
- The health of some birds is extremely sensitive to the fumes given off during the self-cleaning cycle of any range. Move birds to another well-ventilated room.

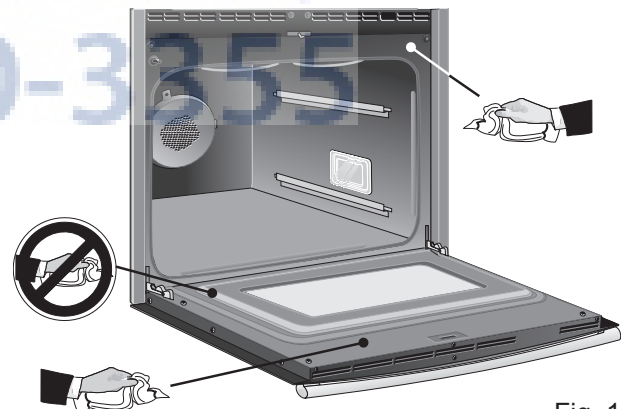



Fig. 1

REMOVE RACKS

Fig. 2

Setting self-clean

The clean feature provides 3 different choices for self-cleaning the oven. Set the clean for **lite** (2 hrs), **med** (3 hrs) or **heavy** soils (4 hrs). The example below shows setting the oven for self-clean to begin immediately using a medium (3 hour) setting:

Example	
Step	Press
1. Remove racks and supports and press UPPER OVEN	UPPER OVEN
2. Press CLEAN	
3. Select MED or select lite or heavy	med
4. Press START	

After pressing start, the motorized oven door latch will automatically lock the door. The **DOOR** lock icon will flash (Fig. 1). Once the door has locked the **DOOR** lock icon will remain on through the entire self-clean cycle.

After self-clean, the oven may take about 30-40 minutes to cool and unlock. A **Hot** message (Fig. 2) will display during this period. During cooling the **DOOR** lock icon will flash and disappear indicating that the door has unlocked.

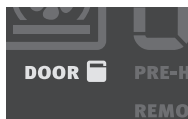

Fig. 1







Fig. 2

Setting delayed self-clean

You may wish to set your appliance to perform a self-clean cycle sometime later (up to 12 hours later). The **END TIME** key will determine when the cleaning will stop.

You will need to set the **END TIME** out far enough to allow for the type of clean cycle you choose (2-3-4 hours). Remember to add 30-40 additional minutes for the oven to cool enough and the oven door to unlock.

The example below shows setting the oven for a lite (2 hour) self-clean cycle to end at 8:00 o'clock:

Example	
Step	Press
1. Remove racks and press UPPER OVEN	UPPER OVEN
2. Press CLEAN	
3. Select LITE	lite
4. Press COOK OPTIONS	
5. Press END TIME	
6. Enter 800	800
7. Press START	

→ IMPORTANT

- A self-clean cycle will not start if the appliance has the **CONTROL LOCK** turned on.
- If a self-clean cycle was started but did not finish due to a power failure, your oven may not be completely cleaned. After power has been restored and the oven door has unlocked, set for another self-clean if needed.

🗨️ NOTE

You may press **CANCEL** any time during the cleaning process. After cancelling the self-clean cycle, do not attempt to open the oven door until the **DOOR** lock icon turns off.

Cleaning Recommendations

Surface Type	Cleaning Recommendation
<ul style="list-style-type: none"> • Aluminum (trim pieces) & vinyl (some models) 	Use hot, soapy water and a cloth. Dry with a clean cloth.
<ul style="list-style-type: none"> • Painted and plastic control knobs • Body parts • Painted decorative trim 	<p><i>For general cleaning</i>, use hot, soapy water and a cloth. <i>For more difficult soils and built-up grease</i>, apply a liquid detergent directly onto the soil. Leave on soil for 30 to 60 minutes. Rinse with a damp cloth and dry. Do not use abrasive cleaners on any of these materials; they can scratch.</p> <p>To remove control knobs, turn to the OFF position; grasp firmly and pull straight off the shaft. To replace knobs after cleaning, line up the flat sides of both the knob and the shaft; then push the knob into place.</p>
<ul style="list-style-type: none"> • Control panel (some models) • Decorative trim (some models) • Stainless steel (some models) 	<p><i>Before cleaning the control panel</i>, turn all controls to OFF and remove the control knobs. To remove, pull each knob straight off the shaft. Clean using hot, soapy water and a dishcloth. Rinse with a clean water using a dishcloth. Be sure to squeeze excess water from the cloth before wiping the panel; especially when wiping around the controls. Excess water in or around the controls may cause damage to the appliance. To replace knobs after cleaning, line up the flat sides of both the knob and the shaft; then push the knob into place.</p> <p>Stainless Steel (some models). Clean the stainless with warm soapy water using a clean sponge or cloth. Rinse with clean water and dry with a soft clean cloth. Do not use harsh scrubbing cleaners. Only use kitchen cleaners that are especially made for cleaning Stainless Steel. Always be sure to rinse the cleaners from the surface as bluish stains may occur during heating that cannot be removed.</p>
<ul style="list-style-type: none"> • Porcelain enamel broiler pan and insert (if equipped) • Door liner & body parts 	Gentle scouring with a soapy scouring pad will remove most spots. Rinse with a 1:1 solution of clear water and ammonia. <i>If necessary</i> , cover difficult spots with an ammonia-soaked paper towel for 30 to 40 minutes. Rinse with clean water and a damp cloth, and then scrub with a soap-filled scouring pad. Rinse and wipe dry with a clean cloth. Remove all cleaners or the porcelain may become damaged during future heating. Do not use spray oven cleaners on the cooktop.
<ul style="list-style-type: none"> • Oven racks 	Oven racks must be removed. Clean by using a mild, abrasive cleaner following manufacturer's instructions. Rinse with clean water and dry.
<ul style="list-style-type: none"> • Oven door 	<p>Use soap & water to thoroughly clean the top, sides and front of the oven door. Rinse well. You may use a glass cleaner on the outside glass of the oven door. Do not immerse the door in water. Do not spray or allow water or the glass cleaner to enter the door vents. Do not use oven cleaners, cleaning powders or any harsh abrasive cleaning materials on the outside of the oven door.</p> <p>Do not clean the oven door gasket. The oven door gasket is made of a woven material, on Self-Cleaning models, which is essential for a good seal. Care should be taken not to rub, damage or remove this gasket.</p>

Special door care instructions

→ IMPORTANT

Most oven doors contain glass that can break.
Read the following recommendations:

- **Do not** close the oven door until all the interior oven racks are fully inserted and retracted to the back of the oven.
- Do not hit the glass with pots, pans, or any other object. The oven door glass may break or even break at a later time unexpectedly.
- Scratching, hitting, jarring or stressing the oven door glass may weaken its structure causing an increased risk of breakage at a later time.
- You may use a glass cleaner on the outside of the oven door glass. **Do not spray** or allow water or the cleaner to enter or drip down into the oven door vents. Spray cleaner on cloth first and then wipe the oven door clean.
- **Do not** use strong oven cleaners, powders or any harsh abrasive cleaning materials on the outside of the oven door or glass.
- **Never clean** the oven door gasket. The oven door gasket should always clean during the Self-clean cycle.

Changing oven lights

⚠ CAUTION

Be sure the range is unplugged and all parts are COOL before replacing oven light. Wear a leather-faced glove for protection against possible broken glass or burns.

The oven light bulbs are located on both side of the oven cavity and both are covered with a glass shield. The glass shield must be in place whenever the oven is in use.

Replacing the oven interior light bulbs:

1. Turn electrical power off at the main source or unplug the appliance.
2. Remove oven interior light shield as illustrated below.
3. Replace bulb with a new appliance bulb. Please note: Do not allow your fingers to touch the new bulb when replacing. This will shorten the life of the new bulb. Use a paper towel to cover the new bulb when installing.
4. Replace glass shield over bulb.
5. Turn power back on again at the main source (or plug the appliance back in).
6. The clock will then need to be reset.

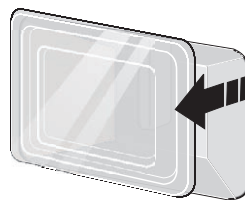

**Lift backside
of glass shield
and remove it.**

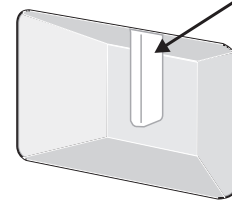

**Halogen
Light Bulb**

The oven door with Luxury-Hold™ hinges

CAUTION

- To prevent possible burns, do not attempt to remove the oven door until the oven has completely cooled.
- To avoid possible injury to hands when removing or replacing the oven door, follow the instructions below carefully and always hold the oven door with hands positioned away from the door hinge area (See Fig. 3).

IMPORTANT

The oven door is heavy. Be careful when removing and lifting the door. Do not lift the oven door by the handle.

1. Fully open the oven door.
2. Unlock both oven door hinge locks by pulling them up and away from the oven frame until they stop (unlocked position) -Fig. 2-. If needed use a small flat-bladed screwdriver to assist with loosening the door hinge locks.
3. Firmly grasp both sides of oven door -Fig. 3-.
4. Before completing this step, be prepared to hold the whole weight of the door while grasping the sides of the oven door with both hands. Hold midway down the oven door sides. Close the oven door to about 4 inches and continue closing beyond the door stop position. The oven door should release from the frame on its own -Fig. 3-.
5. Carefully lift door away evenly, slightly up and out until both hinge arms are clear of the hinge slots in the oven frame -Fig. 3-. After door has been removed, be sure to lay the door flat with the inside of the door downward (never rest the oven door with any weight on the door handle).

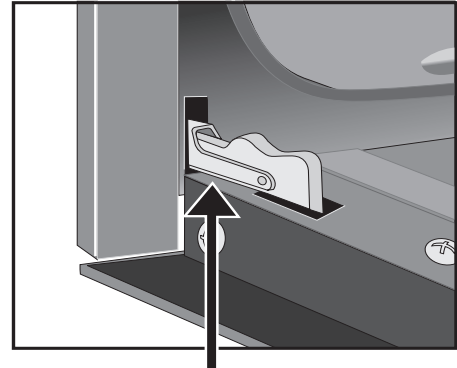

Lock in normal position

Fig. 1

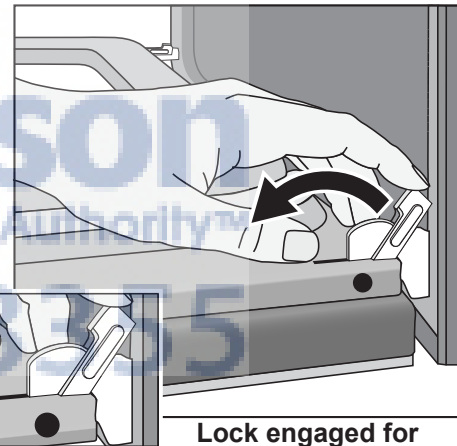

Lock engaged for door removal

Fig. 2

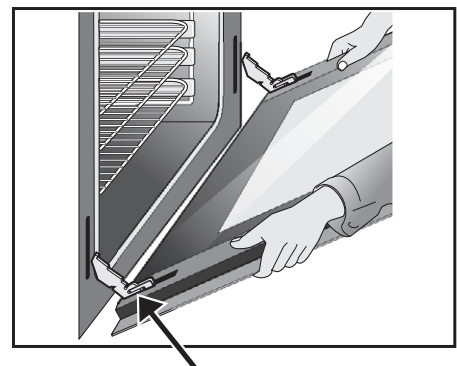

HINGE SLOT - Door removed from the appliance

Fig. 3

The oven door with Luxury-Hold™ hinges (continued)

To replace the Lift-Off oven door

1. Firmly grasp the oven door along both sides just below the door handle. When positioning the door hinge arms with the door hinge slots in the oven frame, you may wish to use your knee to stabilize the door before attempting to insert the door hinge arms in the hinge slots.
2. Position the angle of the door to the door removal angle and carefully insert the door hinge arms fully and evenly into the door hinge slots. Carefully let the weight of the door transfer from your hands so that the oven now supports the oven door.
3. Open the oven door down to the fully open position.
4. With the door in the fully open position, push both oven door hinge locks toward the oven frame until they both are locked.
5. Close the oven door.

Broiler pan cleaning tips

To make cleaning easier, line the bottom of the broiler pan with aluminum foil. DO NOT cover the broiler grid with foil.

To prevent grease from baking on, remove the broiler pan from the oven as soon as cooking is completed. Use hot pads because the broiler pan is extremely hot. Pour off grease. Soak the pan in HOT, soapy water.

Clean the broiler pan as soon as possible after each use. If necessary, use soap-filled steel wool pads. Heavy scouring may scratch the grid.

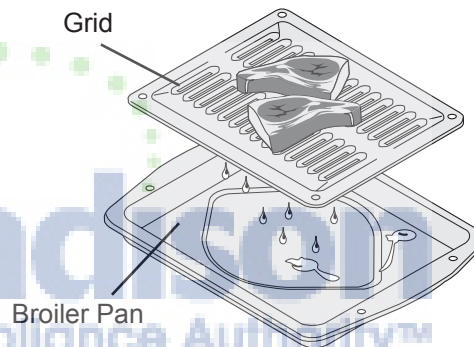

AJ Madison
Your Appliance Authority™
800-570-3355

Cleaning cooktop, burner grates, caps and heads

The cooktop is designed to make cleaning easier. Because the gas burner are sealed, cleanups are easy when spillovers are cleaned up immediately.

CAUTION

Do not remove any parts from the cooktop until they have completely cooled and are safe to handle.

IMPORTANT

Do not use spray oven cleaners on the cooktop.

Cleaning the cooktop

If a spill occurs on or in the recessed or countered areas, blot up spill with an absorbent cloth. Rinse with a clean, damp cloth and wipe dry. Do not use harsh abrasive cleaners on the cooktop. They can scratch the porcelain. Completely rinse any mild cleaners used from the surface or the porcelain cooktop may become damaged during future heating.

Cleaning the grates

The burner grates are dishwasher safe and may be cleaned in the dishwasher. Remove any excessive soils before placing in the dishwasher.

IMPORTANT

- For proper gas flow and ignition of the burners — **DO NOT allow spills, food, cleaning agents or any other material to enter the gas orifice opening.**
- The cooktop is not removable. Do not attempt to remove or lift the cooktop.

CAUTION

- To avoid possible burns use care when cleaning the cooktop. **DO NOT** attempt to clean the cooktop whenever the cooktop or burner heads are still hot.
- To avoid possible burns **DO NOT** attempt any of the following cleaning instructions provided before turning OFF all of the surface burners and allow them to cool.
- To avoid possible burns **DO NOT** attempt to operate the surface burners without the burner caps.

Your appliance is shipped with the burner heads and burner caps in the correct locations. Before using your gas appliance be sure to:

- Follow installation instructions before operating.
- Remove all packing tape from cooktop area.

Burner Caps

Should you ever need to remove the burner caps for cleaning lift the burner cap off the burner head. Clean heavy soils with an absorbent cloth. Rinse with a clean, damp cloth and immediately **thoroughly** dry including the bottom and inside of the cap. Do not use harsh abrasive cleaners. They can scratch the porcelain on the cap. Do not clean burner caps in dishwasher.

When placing the burner caps, see Important note below.

IMPORTANT

When placing the burner caps on the cooktop, be sure the burner caps are seated firmly on top of burner heads. Improper flame size and uneven heating may result when any surface burners are turned ON and the burner caps are not seated correctly.

Cleaning cooktop, burner grates, caps and heads

Double ring burner cap

The glass in the double ring is designed to fit loosely. Clean with normal non abrasive glass type cleaner and thoroughly dry before replacing.

Burner heads

Lift the burner cap from the burner head. The surface burner heads are secured to the cooktop and **must be cleaned in place**.

For proper gas flow it may be necessary to clean the burner heads and slots. To clean, first use a clean DAMP cloth to soak up any spills. Remove any food from between the burner slots using a small nonabrasive brush like a toothbrush and afterwards wipe using a damp cloth. For stubborn soils located in the slots, use a small-gauge wire or needle to clean.

Should you experience ignition problems it may be that an ignition port hole is partially blocked with soil (see figs 1 & 2). With the burner head in place, use a small wire gauge needle or the end of a paper clip to clear the ignition port or ports.

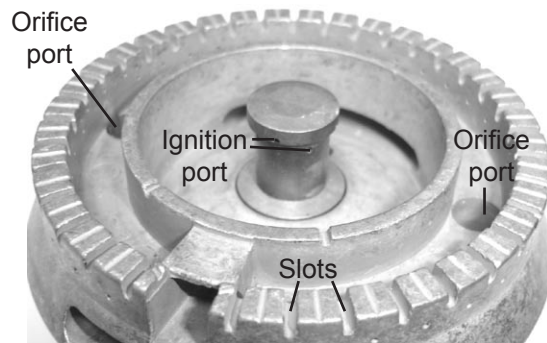

Figure 2 - Double ring burner head
(Models equipped with double ring burner only)

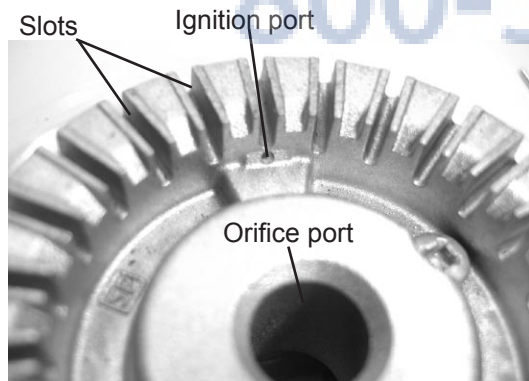

Figure 1 - Cooktop burner head
(All burners except Double ring burner)

Before you call for service, review the following list. It may save you time & expense. The list includes common occurrences that are not the result of defective workmanship or materials in this appliance.

Before you call	
Problem	Solution
Oven control beeps and displays an F error code.	<ul style="list-style-type: none"> Electronic control has detected a fault condition. Push CANCEL pad to clear the display and stop the display from beeping. Reprogram the oven. If a fault reoccurs, record the fault number, push the CANCEL pad and contact an authorized servicer.
Installation	<ul style="list-style-type: none"> Place oven rack in center of oven. Place a level on the oven rack. Contact installing agent if rack and cabinet cutout flooring are not level. Kitchen cabinet misalignment may make range appear to be not level. Be sure cabinets are square and level. Contact cabinet maker to correct problem.
Entire range does not operate	<ul style="list-style-type: none"> When the range is first plugged in, or when the power supply to the oven has been interrupted, the display will flash. The range cannot be programmed until the clock is set. Be sure electrical cord is securely connected into the electrical junction box. Cord/plug is not installed and/or connected. Cord is not supplied with range. Contact your dealer, installing agent or authorized servicer. Service wiring not complete. Contact your dealer, installing agent or authorized servicer. Power outage. Check house lights to be sure. Call your local electric company. Short in cord/plug. Replace cord/plug. Controls are not set properly. See instructions to set the controls. House fuse has blown or circuit breaker has tripped immediately following installation. House fuse may not be fully engaged. Check fuse and screw or engage circuit breaker securely.
Oven light does not work	<ul style="list-style-type: none"> Burned-out or loose bulb. Follow the instructions under Oven Light to replace or tighten the bulb.
Self-cleaning cycle does not work	<ul style="list-style-type: none"> Make sure the oven door is closed. Make sure you have removed the oven racks and the oven rack supports from the oven. Controls not set properly. Follow instructions under "Using the Self-Clean Feature".
Poor cooking results	<ul style="list-style-type: none"> Many factors affect baking results. See baking for hints, cause and corrections. See Adjusting Oven Temperature. Adjust the recipe's recommended power levels or cooking times. Cookware is too lightweight or warped. Use heavier quality cookware so foods being prepared may cook more evenly.
Flames inside oven or smoking from oven vent	<ul style="list-style-type: none"> Excessive spillovers in oven. For example this will happen for pie spillovers or large amounts of grease left on the oven bottom. Wipe up excessive spillovers before starting oven. If flames or excessive smoke are present see "About broiling" in the Setting Lower Oven Controls section.





Before you call

Problem	Solution
Oven smoke excessively during broiling	<ul style="list-style-type: none"> • Meat too close to the broiler element. Reposition the rack to provide more clearance between the meat and the broiler. Preheat broil element for quick searing operation. • Meat not properly prepared. Remove excess fat from meat. Cut remaining fatty edges to prevent curling, but do not cut into the lean. • Grid on broiler pan wrong side-up. Grease does not drain into broiler pan. Always place the grid on the broiler pan with the ribs up and the slots down to allow grease to drip into the pan. • Broiler pan used without grid or grid cover with aluminum foil. DO NOT use the broiler pan without the grid or cover the grid with aluminum foil. • Oven needs to be cleaned. Grease has built up on oven surfaces. Regular cleaning is necessary when broiling frequently. Grease or food spatters cause excessive smoking.
Soil not completely removed after self-cleaning cycle is completed	<ul style="list-style-type: none"> • Failure to clean bottom, from top of oven, frame of oven or door area outside oven seal. These areas are not in the self-cleaning area, but get hot enough to burn on residue. Clean these areas before the self-cleaning cycle is started. Burned on residue can be cleaned with a stiff nylon brush and water or a nylon scrubber. Be careful not to damage the oven gasket. • Excessive spillovers in oven. Set the self-clean cycle for longer cleaning time.
Surface burners do not light	<ul style="list-style-type: none"> • Surface Control knob has not been completely turned to LITE. Push in and turn the Surface Control knob to LITE until burner ignites and then turn control knob to desired flame size. • Be sure gas supply valve is open. • Burner ports are clogged. Clean burners. See Cleaning the Burner Grates, Burner Caps, Burner Heads in General Care & Cleaning section. With the burner off, clean ports with a small-gauge wire or needle. • Power cord is disconnected from outlet (Electric Ignition Models only). Be sure cord is securely plugged into the outlet. • Electrical power outage (electric ignition models only). Burners can be lit manually. See Setting Surface Controls in this Use and Care Guide.
Burner flame only lights half way around burner	<ul style="list-style-type: none"> • Burner ports are clogged. With the burner off, clean ports by using a small-gauge wire or needle. • Moisture is present after cleaning. Lightly fan the flame and allow burner to operate until flame is full. Dry the burners thoroughly following instructions in the General Cleaning section.
Food not heating evenly	<ul style="list-style-type: none"> • Improper cookware. Select flat-bottomed cookware of a proper size to fit element. • Incorrect control setting. Raise or lower setting until proper amount of heat is obtained.
Burner flame is orange	<ul style="list-style-type: none"> • Dust particles in main line. Allow the burner to operate a few minutes until flame turns blue. • In coastal areas, a slightly orange flame is unavoidable due to salt air. Ceramic-Glass Cooktop section in this Owner's Guide.

Baking problems

For best cooking results pre-heat the oven when baking cookies, breads, cakes, pies or pastries, etc. There is no need to preheat the oven for roasting meats or baking casseroles. The cooking times and temperatures needed to bake a product may vary slightly from your previous appliance.

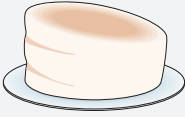
Baking Problems and Solutions Chart

BAKING PROBLEMS	CAUSES	CORRECTIONS
Cookies and biscuits burn on the bottom. 	<ul style="list-style-type: none"> • Cookies and biscuits put into the oven before the preheating time is completed. • Oven rack overcrowded. • Dark pan absorbs heat too fast. 	<ul style="list-style-type: none"> • Allow oven to preheat to the selected temperature before placing food in oven. • Choose pan sizes that will permit 5.1cm to 10.2cm (2" to 4") of air space on all sides when placed in the oven. • Use a medium-weight aluminum baking sheet.
Cakes too dark on top or bottom. 	<ul style="list-style-type: none"> • Cakes put into the oven before preheating time is completed. • Rack position too high or low. • Oven too hot. 	<ul style="list-style-type: none"> • Allow oven to preheat to the selected temperature before placing food in the oven. • Use proper rack position for baking needs. • Set oven temperature 25°F/12°C lower than recommended.
Cakes not done in the center. 	<ul style="list-style-type: none"> • Oven too hot. • Incorrect pan size. • Pan not centered in oven. 	<ul style="list-style-type: none"> • Set oven temperature 25°F/12°C lower than recommended. • Use pan size suggested in recipe. • Use proper rack position and place pan so there is 5.1cm to 10.2cm (2" to 4") of space on all sides of pan.
Cakes not level. 	<ul style="list-style-type: none"> • Range not level. • Pan too close to oven wall or rack overcrowded. • Pan warped. 	<ul style="list-style-type: none"> • Place a marked glass measuring cup filled with water on the center of the oven rack. If the water level is uneven, refer to the installation instructions for leveling the range. • Be sure to allow 5.1cm to 10.2cm (2" to 4") of clearance on all sides of each pan in the oven. • Do not use pans that are dented or warped.
Foods not done when cooking time is up. 	<ul style="list-style-type: none"> • Oven too cool. • Oven overcrowded. • Oven door opened too frequently. 	<ul style="list-style-type: none"> • Set oven temperature 25°F/12°C higher than suggested and bake for the recommended time. • Be sure to remove all pans from the oven except the ones to be used for baking. • Open oven door only after shortest recommended baking time.

Your appliance is covered by a one year limited warranty. For one year from your original date of purchase, Electrolux will repair or replace any parts of this appliance that prove to be defective in materials or workmanship when such appliance is installed, used, and maintained in accordance with the provided instructions. In addition, the glass cooktop or radiant surface element of your appliance (excluding built-in and free-standing range appliances) is covered by a two through five year limited warranty. During the 2nd through 5th years from your original date of purchase, Electrolux will provide a replacement glass cooktop or radiant surface element for your appliance which has proven to be defective in materials or workmanship when such appliance is installed, used, and maintained in accordance with the provided instructions.

Exclusions

This warranty does not cover the following:

1. Products with original serial numbers that have been removed, altered or cannot be readily determined.
2. Product that has been transferred from its original owner to another party or removed outside the USA or Canada.
3. Rust on the interior or exterior of the unit.
4. Products purchased "as-is" are not covered by this warranty.
5. Products used in a commercial setting.
6. Service calls which do not involve malfunction or defects in materials or workmanship, or for appliances not in ordinary household use or used other than in accordance with the provided instructions.
7. Service calls to correct the installation of your appliance or to instruct you how to use your appliance.
8. Expenses for making the appliance accessible for servicing, such as removal of trim, cupboards, shelves, etc., which are not a part of the appliance when it is shipped from the factory.
9. Service calls to repair or replace appliance light bulbs, air filters, water filters, other consumables, or knobs, handles, or other cosmetic parts.
10. Labor or in-home service costs during the additional limited warranty periods beyond the first year from your original date of purchase.
11. Pickup and delivery costs; your appliance is designed to be repaired in the home.
12. Surcharges including, but not limited to, any after hour, weekend, or holiday service calls, tolls, ferry trip charges, or mileage expense for service calls to remote areas, including the state of Alaska.
13. Damages to the finish of appliance or home incurred during transportation or installation, including but not limited to floors, cabinets, walls, etc.
14. Damages caused by: services performed by unauthorized service companies; use of parts other than genuine Electrolux parts or parts obtained from persons other than authorized service companies; or external causes such as abuse, misuse, inadequate power supply, accidents, fires, or acts of God.

DISCLAIMER OF IMPLIED WARRANTIES; LIMITATION OF REMEDIES

CUSTOMER'S SOLE AND EXCLUSIVE REMEDY UNDER THIS LIMITED WARRANTY SHALL BE REPAIR OR REPLACEMENT AS PROVIDED HEREIN. CLAIMS BASED ON IMPLIED WARRANTIES, INCLUDING WARRANTIES OF MERCHANTABILITY OR FITNESS FOR A PARTICULAR PURPOSE, ARE LIMITED TO ONE YEAR OR THE SHORTEST PERIOD ALLOWED BY LAW, BUT NOT LESS THAN ONE YEAR. ELECTROLUX SHALL NOT BE LIABLE FOR CONSEQUENTIAL OR INCIDENTAL DAMAGES SUCH AS PROPERTY DAMAGE AND INCIDENTAL EXPENSES RESULTING FROM ANY BREACH OF THIS WRITTEN LIMITED WARRANTY OR ANY IMPLIED WARRANTY. SOME STATES AND PROVINCES DO NOT ALLOW THE EXCLUSION OR LIMITATION OF INCIDENTAL OR CONSEQUENTIAL DAMAGES, OR LIMITATIONS ON THE DURATION OF IMPLIED WARRANTIES, SO THESE LIMITATIONS OR EXCLUSIONS MAY NOT APPLY TO YOU. THIS WRITTEN WARRANTY GIVES YOU SPECIFIC LEGAL RIGHTS. YOU MAY ALSO HAVE OTHER RIGHTS THAT VARY FROM STATE TO STATE.

If You Need Service

Keep your receipt, delivery slip, or some other appropriate payment record to establish the warranty period should service be required. If service is performed, it is in your best interest to obtain and keep all receipts. Service under this warranty must be obtained by contacting Electrolux at the addresses or phone numbers below.

This warranty only applies in the USA, Puerto Rico and Canada. In the USA and Puerto Rico, your appliance is warranted by Electrolux Major Appliances North America, a division of Electrolux Home Products, Inc. In Canada, your appliance is warranted by Electrolux Canada Corp. Electrolux authorizes no person to change or add to any obligations under this warranty. Obligations for service and parts under this warranty must be performed by Electrolux or an authorized service company. Product features or specifications as described or illustrated are subject to change without notice.

USA

1.800.944.9044

Electrolux Home Products, Inc.,
10200 David Taylor Drive
Charlotte, NC 28262

Canada

1-800-265-8352

Electrolux Canada Corp.
5855 Terry Fox Way
Mississauga, Ontario, Canada L5V 3E4



 **Electrolux**
