



INSTRUCTION MANUAL

Microwave Oven

**MFM-7TP/MFM-7TPW
MFM-7TPS**

TABLE OF CONTENTS

Safety Instructions

■ PRECAUTIONS TO AVOID POSSIBLE EXPOSURE TO EXCESSIVE MICROWAVE ENERGY	1
■ Specifications	1
■ Proper and Safe Use of Your Oven	1
■ Important Safety Instructions	2

Setting Up & Getting to Know Your Oven

■ What is Safe Plug® Technology?	3
■ Electrical Grounding Instructions	3
■ Installation	4
■ Cleaning	4
■ Names of Oven Parts and Accessories	5
■ Control Panel and Features	6

Operating Instructions

■ Operating Instructions	7
• Setting Clock	7
• Child Lock-Out	8
• Popcorn	8
• Soup	9
• Beverage	9
• Pizza	10
• Reheating (Dinner Plate)	10
• Time Defrost	11
• Time Cook	11
• Wattage Output Chart	12
• Express Cook	13
• Beeper Volume	13
• To Stop the Oven While it is Operating	13
• Charger Outlets	14

Read these instructions carefully before using these ovens. If you follow the instructions, your microwave oven will provide you with many years of good service.

SAVE THESE INSTRUCTIONS

■ Warranty	15
------------------	----

SPECIFICATIONS

Model	MFM-7TP/MFM-7TPW/MFM-7CTPS
Power Source	AC120 V, 60 HZ
Power Consumption	1680 W
Maximum Output	700 W*
Defrost Output	280 W
Oven Capacity	0,7 cu. ft.
Turntable Diameter	10.7"(272mm)
Dimensions (w x d x h)	18.1"(W) × 12.8"(D) × 10.6"(H) (460 × 325 × 269mm)
Weight (Approx.)	29 lb (13,2 kg)

*According to IEC test procedures.
Specifications subject to change without notice.

PROPER AND SAFE USE OF YOUR OVEN

- The oven must be level.
- The turntable and turntable roller guide must be in the oven during cooking.
- Place the cookware gently on the turntable and handle it carefully to avoid possible breakage.
- Use only the specified bag size when using Popcorn. See page 8.
- The oven has several built-in safety switches to ensure that the power remains off when the door is open. Do not tamper with these switches.
- Do not operate the microwave oven empty. Operating the oven with no food or food that is extremely low in moisture can cause fire, charring or sparking.
- Do not cook bacon directly on the turntable. Excessive local heating of the turntable may cause it to break.
- Do not heat baby bottles or baby food in the microwave oven. Uneven heating may occur and cause physical injury.
- Do not heat narrow-necked containers, such as syrup bottles.
- Do not attempt to deep-fry in your microwave oven.
- Do not do home canning in this microwave oven as it is impossible to be sure all contents of the jar have reached a boiling temperature.
- Do not use this microwave oven for commercial purposes. This microwave oven is made for non-commercial use only.
- Do not use the socket located on the back panel of the Microwave Oven for any purpose other than to plug in the refrigerator cord. Do not plug other electrical items into this socket.

PRECAUTIONS TO AVOID POSSIBLE EXPOSURE TO EXCESSIVE MICROWAVE ENERGY

- (a) Do not attempt to operate this oven with the door open since open-door operation can result in harmful exposure to microwave energy. It is important not to defeat or tamper with the safety interlocks.
- (b) Do not place any object between the oven front face and the door or allow soil or cleaner residue to accumulate on sealing surfaces.
- (c) Do not operate the oven if it is damaged.
It is particularly important that the oven door closes properly and that there is no damage to the: (1) door (bent), (2) hinges and latches (broken or loosened), (3) door seals and sealing surfaces.
- (d) The oven should not be adjusted or repaired by anyone except properly qualified service personnel.

IMPORTANT SAFETY INSTRUCTIONS

When using electrical appliances, basic safety precautions should be followed, including the following:

WARNING: To reduce the risk of burns, electric shock, fire, injury to persons or exposure to excessive microwave energy:

- 1 Read all instructions before using this appliance.
- 2 Read and follow the specific "PRECAUTIONS TO AVOID POSSIBLE EXPOSURE TO EXCESSIVE MICROWAVE ENERGY" found on page 1.
- 3 This appliance must be grounded. Connect only to a properly grounded outlet. See "GROUNDING INSTRUCTIONS" found on page 3.
- 4 Install or locate this appliance only in accordance with the provided installation instructions.
- 5 Some products such as whole eggs and sealed containers-for example, closed glass jars - are able to explode and should not be heated in this oven.
- 6 Use this appliance only for its intended use as described in this manual. Do not use corrosive chemicals or vapors in this appliance. This type of oven is specifically designed to heat, cook, or dry food. It is not designed for industrial or laboratory use.
- 7 As with any appliance, close supervision is necessary when used by children.
- 8 Do not operate this appliance if it has a damaged cord or plug, if it is not working properly, or if it has been damaged or dropped
- 9 This appliance should be serviced only by qualified service personnel. Contact MicroFridge®, 2 Annette Road, Suite 3, Foxborough, MA 02035 or at 1-800-637-7567 for the nearest authorized service facility for examination, repair or adjustment.
- 10 Do not cover or block any openings or vents on this appliance.
- 11 Do not store this appliance outdoors. Do not use this product near water-for example, near a kitchen sink, in a wet basement, near a swimming pool, or similar locations.
- 12 Do not immerse cord or plug in water.
- 13 Keep cord away from heated surfaces.
- 14 Do not let cord hang over edge of table or counter.
- 15 When cleaning surfaces of door and oven that comes together on closing the door, use only mild, non-abrasive soaps or detergents applied with a sponge or soft cloth.
- 16 To reduce the risk of fire in the oven cavity:
 - (a) Do not overcook food. Carefully attend appliance when paper, plastic, or other combustible materials are placed inside the oven to facilitate cooking .
 - (b) Remove wire twist-ties from paper or plastic bags before placing bag in oven. Do not heat Chinese food containers or foil lined bags.
 - (c) If materials inside the oven ignite, keep oven door closed, turn oven off, and disconnect the power cord, or shut off power at the fuse or circuit breaker panel.
 - (d) Do not use the cavity for storage purposes. Do not leave paper products, cooking utensils, or food in the cavity when not in use.
- 17 Liquids, such as water, coffee, or tea are able to be overheated beyond the boiling point without appearing to be boiling. Visible bubbling or boiling when the container is removed from the microwave oven is not always present. **THIS COULD RESULT IN VERY HOT LIQUIDS SUDDENLY BOILING OVER WHEN THE CONTAINER IS DISTURBED OR A SPOON OR OTHER UTENSIL IS INSERTED INTO THE LIQUID.**

To reduce the risk of injury to persons:

 - (a) Do not overheat the liquid.
 - (b) Stir the liquid both before and halfway through heating it.
 - (c) Do not use straight-sided containers with narrow necks.
 - (d) After heating, allow the container to stand in the microwave oven for a short time before removing the container.
 - (e) Use extreme care when inserting a spoon or other utensil into the container.
- 18 Under-cabinet and wall-mounted appliances:
 - (a) Do not operate any heating or cooking appliance beneath this appliance.
 - (b) Do not mount unit over or near any portion of a heating or cooking appliance.
 - (c) Do not mount over a sink.
 - (d) Do not store anything directly on top of the appliance surface when the appliance is in operation.

SAVE THESE INSTRUCTIONS

What is Safe Plug® Technology?

MicroFridge® combination appliances utilize Safe Plug® technology, a revolutionary, patent pending design, to conserve electricity and reduce potential fire hazards that can be caused by overloaded circuits. This technology, built into the microwave, works by temporarily shutting off the power to the refrigerator and charging outlets when the microwave is in use. When the microwave is finished, power to the refrigerator and charging outlets resumes. Engineered with unique one-plug-to-the-wall operation, our combination appliances never draw more than 11-15 amps of current.

MicroFridge® with Safe Plug® uses patent-pending intelligent load monitoring technology to control the microwave, refrigerator and extra outlets. The two charging outlets are designed to conveniently re-charge cell phones, digital cameras, i-Pods, laptops or similar low power devices.

ELECTRICAL GROUNDING INSTRUCTIONS

This appliance must be grounded. If there is an electrical short circuit, grounding reduces the risk of electric shock by providing an escape wire for the electric current. This appliance is equipped with a cord that has a grounding wire with a grounding plug. The plug must be plugged into an outlet that is properly installed and grounded.

Consult a qualified electrician if the grounding instructions are not completely understood as to whether the appliance is properly grounded.

Properly polarized and grounded

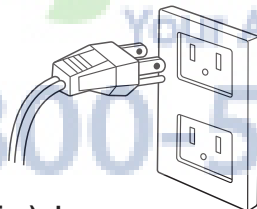

Three-pronged (grounding) plug

If it is necessary to use an extension cord, use only a 3-wire extension cord that has a 3-blade grounding plug, and a 3-slot receptacle that will accept the plug on the appliance. The marked rating of the extension cord shall be equal to or greater than the electrical rating of the appliance.

- a) A short power-supply cord is provided to reduce the risks resulting from becoming entangled in or tripping over a longer cord.
- b) Longer cord sets or extension cords are available and may be used if care is exercised in their use.
- c) If a long cord or extension cord is used:
 - 1) The marked electrical rating of the cord set or extension cord should be at least as great as the electrical rating of the appliance;
 - 2) The extension cord must be a grounding-type 3-wire cord; and
 - 3) The longer cord should be arranged so that it will not drape over the counter top or tabletop where it can be pulled on by children or tripped over unintentionally.

WARNING - Improper use of the grounding plug can result in electric shock.

INSTALLATION OF MICROWAVE MODELS TO REFRIGERATOR

Remove all packing material and accessories. Examine the oven for any damage, such as dents or broken door. Do not install if oven is damaged.

1. Place the oven on top of the approved MicroFridge® with Safe Plug® refrigerator carefully lining up screw holes of the refrigerator sash with microwave side holes.
 - Do not block the inlet and outlet openings located at the rear and bottom of the oven.
 - Do not remove the feet from the bottom of oven.
 - Blocking the inlet and/or outlet openings can damage the oven.
2. Attach the microwave oven to the refrigerator by screwing in the four (4) side screws.
 - Screws can be found in the attached bag.
3. Plug refrigerator into the socket provided in the rear of the microwave oven.
 - The socket is intended for use with approved MicroFridge® with Safe Plug® refrigerators. Use of this socket for other appliances may be hazardous.

NOTE:

Radio & TV reception----Poor television reception and radio interference may result if the oven is located close to a TV, radio, antenna or antenna wire. Position the oven as far from them as possible.

MicroFridge® with Safe Plug® Models 2.4MFR,2.9MFR,3.6MFRA,4.8MFR Assembly Diagram.

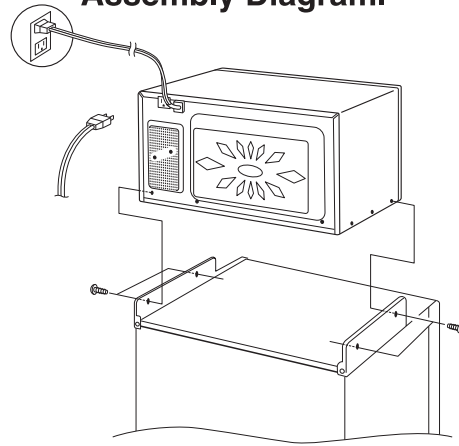

4. Plug your oven into a standard 120-volt/60Hz household outlet. Be sure the electrical circuit is at least 15 amperes and that your microwave oven is the only appliance on the circuit.

The MicroFridge® with Safe Plug® combination appliance will now operate within eleven (11) to fifteen (15) amps of current draw.

NOTE:

The MicroFridge® with Safe Plug® brand refrigerator and charging outlets will not operate when the microwave oven is on. This is part of the patent-pending MicroFridge® with Safe Plug® technology that prevents wiring overload. If your oven does not operate properly, unplug it from the 120 volt household outlet and then plug it back in. This unit is not designed for 50Hz or any circuit other than 120 volt/60Hz AC current.

UNAUTHORIZED MODIFICATIONS TO THIS DEVICE COULD VOID THE USER'S AUTHORITY TO OPERATE IT.

CLEANING

Wipe the oven inside and outside with a soft cloth and a mild detergent solution. Then rinse and wipe dry. This should be done on a weekly basis, more often if needed. Never use cleaning powders or rough pads. Excessive oil splatters on the inside top will be difficult to remove if left for many days. Wipe splatters with a wet paper towel, especially after cooking chicken or bacon.

REMOVABLE PARTS

The following parts may be removed as described. They should be washed in warm (not hot) water with a mild detergent and a soft cloth. Once they are clean, rinse them well and dry with a soft cloth. Never use cleaning powders, steel wool or rough pads.

- The turntable may be cleaned at the sink. Be careful not to chip or scratch the edges as this may cause the turntable to break during use.
- The turntable roller rest should be cleaned regularly.

SPECIAL CARE

For best performance and safety, the inner door panel and the oven front frame should be free of food or grease buildup. Clean them often with a mild detergent. Then rinse and wipe dry. Never use cleaning powders, steel wool or rough pads.

After cleaning the control panel, touch the Clear/Off pad to clear any entries that might have been entered accidentally while cleaning the panel.

NAMES OF OVEN PARTS AND ACCESSORIES

Remove the oven and all materials from the carton.

Your oven comes with the following accessories:

Turntable	1
Roller Guide	1
Instruction Manual and Screws	1

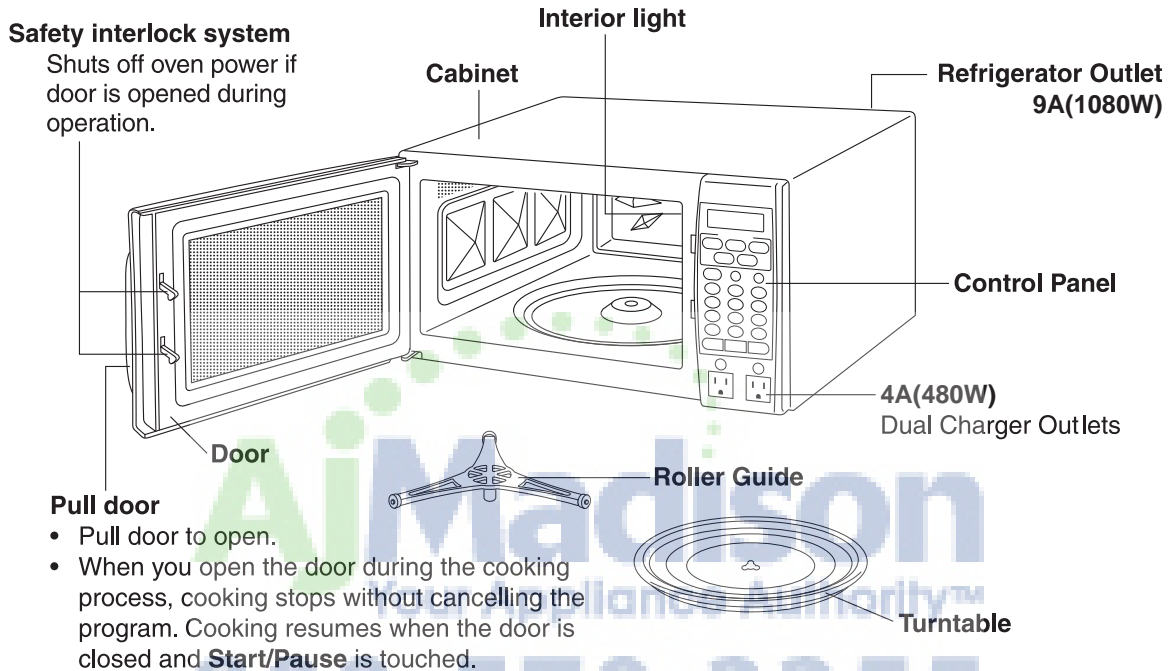

TURNTABLE INSTALLATION

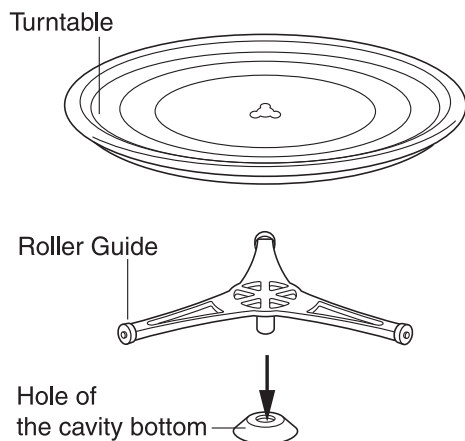

1. Place the roller guide on the cavity bottom.
 2. Place the turntable on top of the roller guide as shown in the diagram. The turntable should never be restricted.
- Both turntable and roller guide must always be used during cooking.
 - All food and containers of food are always placed on this turntable for cooking.
 - This turntable rotates clockwise or counterclockwise; this is normal.

CONTROL PANEL AND FEATURES

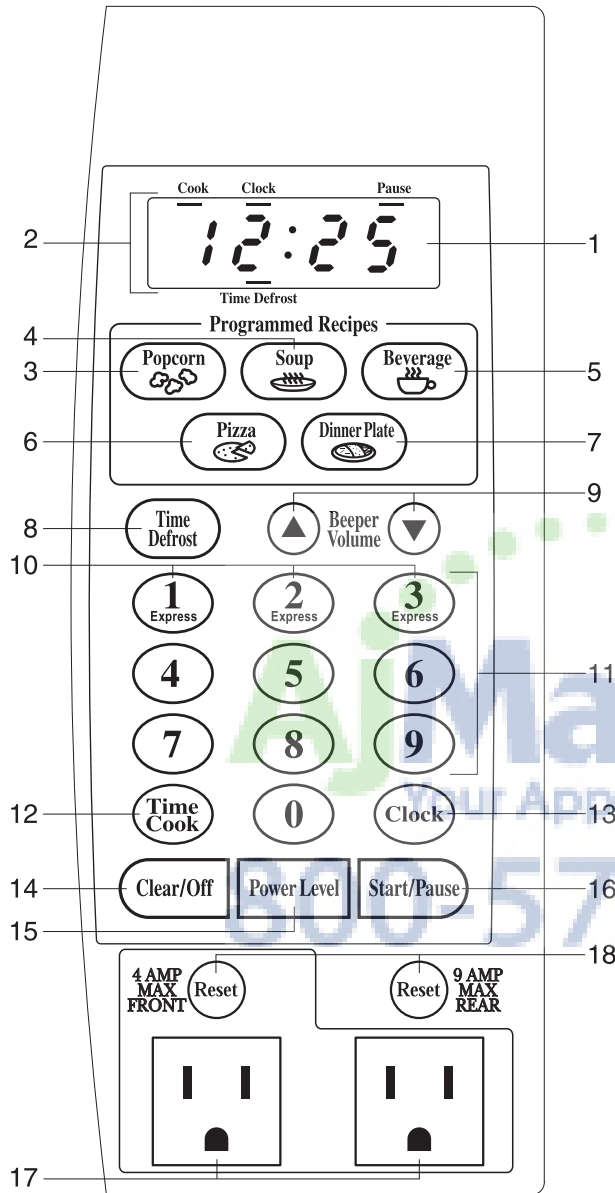

(1) Display Window

Counts down cooking time in seconds during cooking. Shows clock time when oven is not in use.

(2) Indicators

Cook: A flashing indicator shows you that a Cook cycle is functioning.

Clock: Indicates that the display is in the time of day mode.

Pause: A flashing indicator shows that the oven is off, but a cooking program is held in memory.

Time Defrost: A flashing indicator shows you that a Time Defrost cycle is functioning.

Programmed Recipes

- (3) **Popcorn** (page 8)
- (4) **Soup** (page 9)
- (5) **Beverage** (page 9)
- (6) **Pizza** (page 10)
- (7) **Dinner Plate** (page 10)
- (8) **Time Defrost** (page 11)
- (9) **Beeper Volume** (page 13)
- (10) **Express Cook** (page 13)
- (11) **Number Pads**
- (12) **Time Cook** (page 11)
- (13) **Clock** (page 7)
- (14) **Clear/Off** (page 7)
- (15) **Power Level** (page 12)
- (16) **Start/Pause**
- (17) **Charger Outlets** (page 14)
- (18) **Reset Buttons** (page 14)

OPERATING INSTRUCTIONS

SETTING CLOCK

When the oven is first plugged in, the display will flash "0:00" and a tone will sound. If the AC power ever goes off, the display will flash "0:00" when the power comes back on.

To set the clock under the above circumstances, simply enter the correct time of day and then touch the Clock pad.

NOTE:

If the oven is used before the present time is set, the display will show "0" after the cooking is completed and the door is opened. To reset present time in the display window when the oven is off, touch the Clock pad. The colon starts blinking. Enter the correct present time by following the procedures. An improper entry will cause the display to show "Err" and the oven will beep. Repeat steps 1 through 4 entering the correct present time.

Clear/Off

1. Touch the **Clear/Off** pad.

The display will show "0".

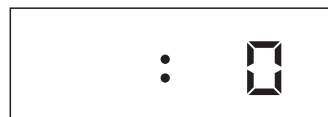

Clock

2. Touch the **Clock** pad.

The display will flash "0:00" and a tone will sound.



3. Enter the correct time of day.

EXAMPLE: To set the time to "10:12", touch "1", "0", "1", "2" in sequence.

The display will show the numbers you pressed in the order you pressed them.



Clock

4. Touch the **Clock** pad.

The display will show the present time and the colon will stop blinking. The 12 hour digital clock allows you to set it from "1:00" to "12:59".



CHILD LOCK-OUT

The child lock prevents unwanted oven operation by small children. The oven can be set so that the control panel is deactivated or locked.

To set Child Lock

1. Touch the “0” pad once.
(No beep sound is heard.)

Start/Pause

2. Touch the **Start/Pause** pad 5 times.
(Beep sound is only heard after the 5th touch.)

The display will show “LO C”

LO C

To cancel Child Lock

1. Touch the “0” pad once.
(No beep sound is heard.)

Start/Pause

2. Touch the **Start/Pause** pad 5 times.
(Beep sound is only heard after the 5th touch.)

The display will return to the present time.

12:34

POPCORN

Place the popcorn package (3.3 oz) onto a microwaveable dish in the oven and close the door.

Popcorn

1. Touch the **Popcorn** pad.

When the **Popcorn** pad is touched, the display will show “PO P”

PO P

Start/Pause

2. Touch the **Start/Pause** pad.

When the **Start/Pause** pad is touched, the display will count down the cooking time of 2:55 and will beep 5 times when cooking is completed. The display will show “End.”

2.55

NOTES:

1. Microwave popcorn bag should be at room temperature.
2. Use only 1 package (approx. 3.3 oz) at a time. Follow package instructions. Do not increase quantity.
3. Use only a microwaveable popcorn package in the microwave oven.
4. Do not try to pop unpopped kernels.
5. Do not leave the oven unattended while popping popcorn. If the popcorn does not pop sufficiently, do not press the **Popcorn** pad again as the popcorn may burn. Check the popcorn bag for cooking instructions.
6. When opening the package, face it away from you to avoid contact with any steam released.
7. Popcorn popping devices are not recommended for use with this feature.

SOUP

Use the Soup feature to heat up to 2 cups (9 oz per cup) of soup.



1. Touch the **Soup** pad repeatedly until the desired number of cups appear in the display window.

EXAMPLE: To select 2 cups, touch the **Soup** pad 2 times; "SU P2" will appear in the display.



NOTE: Up to 2 cups of soup can be heated.
Heating time is as follows:

1 Cup (SU P1): 2 min.: 10 sec.
2 Cups (SU P2): 4 min.: 00 sec.



2. Touch the **Start/Pause** pad.

When the **Start/Pause** pad is touched, the oven will start heating. The display will count down remaining heating time and will beep 5 times when cooking is completed. The display will show "End."



BEVERAGE

Use the Beverage feature to heat up to 2 cups (9 oz per cup) of beverage.



1. Touch the **Beverage** pad repeatedly until the desired number of cups appear in the display window.

EXAMPLE: To select 2 cups, touch the **Beverage** pad 2 times; "CU P2" will appear in the display.



NOTE: Up to 2 cups of beverage can be heated.
Heating time is as follows:

1 Cup (CU P1): 2 min.: 00 sec.
2 Cups (CU P2): 3 min.: 45 sec.



2. Touch the **Start/Pause** pad.

When the **Start/Pause** pad is touched, the oven will start heating. The display will count down remaining heating time and will beep 5 times when cooking is completed. The display will show "End."



PIZZA

Use the Pizza feature to reheat precooked sliced Pizza from the refrigerator. (4 oz per slice)

1 Slice (P 1): 45 sec.
 2 Slices (P 2): 1 min.: 15 sec.



1. Touch the **Pizza** pad once or twice.

When the **Pizza** pad is touched, the display will show "P 1".



2. Touch the **Start/Pause** pad.

When the **Start/Pause** pad is touched, the display will count down the remaining cooking time in minutes and seconds and will beep 5 times when cooking is completed. The display will show "End."



REHEATING (DINNER PLATE)

Use the Dinner Plate feature to reheat precooked foods from the refrigerator.



1. Touch the **Dinner Plate** pad once for regular amount, and twice for a smaller amount of food.

EXAMPLE: For regular amount of food, touch the **Dinner Plate** pad once.

"L" will be displayed. (For a smaller amount "S" will be displayed.)



REGULAR:	A regular amount of food: Approx. 9 oz (for example, 4 oz sliced meat or poultry, 3 oz potato or rice and 2 oz vegetables or equivalent.)
SMALL:	A small amount of food: Approx. 6 oz.

Regular (L): 3 min.: 15 sec.
 Small (S): 2 min.: 00 sec.



2. Touch the **Start/Pause** pad.

When the **Start/Pause** pad is touched, the display will count down the remaining cooking time in minutes and seconds and will beep 5 times when cooking is completed. The display will show "End."



TIME DEFROST

TIME DEFROST lets you easily defrost foods by eliminating guesswork in determining defrosting power. Follow these steps for easy defrosting. If additional defrosting is needed, repeat for a short time, or until defrosting is complete.



1. Touch the **Time Defrost** pad once for each minute of defrosting desired, up to 10 minutes.

EXAMPLE: Touch TIME DEFROST once and the display will show "1.00" and the TIME DEFROST indicator will light.



2. Touch the **Start/Pause** pad.

When the **Start/Pause** pad is touched, the TIME DEFROST indicator will blink, the display will count down the remaining defrosting time in minutes and seconds and will beep 5 times when defrosting is completed. The display will show "End."

TIME COOK

Use the 10 key pads (number pads) to select a cooking time in minutes and seconds, up to ten minutes.



1. Touch the **Time Cook** pad.

The display will show "0"

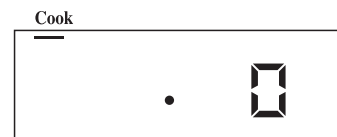

2. Enter the cooking time.

EXAMPLE: To set the cooking time to "9.40", touch "9", "4" and "0" in sequence.



Enter a power level using the numbered pads (1–9). Note that touching pad “1” will produce a 10% power level., pad “2” will produce a 20% power level, etc., through pad “9” which will produce a 90% power level. If the selection is omitted, the oven will automatically cook at full power (100%).

Power Level

- 3. Enter the Power Level. If cooking at full power (100%), omit this step and the oven will cook at full (100%) power.

EXAMPLE: To select 30% power, touch the POWER LEVEL pad and then “3”. The display will show “PL 3”.



COOK indicator will blink, the display will count down the remaining cooking time in minutes and seconds and will beep 5 times when cooking is completed. The display will show “End.”

Start/Pause

- 4. Touch the **Start/Pause** pad.



WATTAGE OUTPUT CHART

Press	Power Level	Wattage Output
none	10	700
9	9	630
8	8	560
7	7	490
6	6	420
5	5	350
4	4	280
3	3	210
2	2	140
1	1	70

EXPRESS COOK

Use this feature to quickly set a short cooking time (1 to 3 minutes) at 100% power. (PL 10).



1. Touch the **1 Express** pad once. The display will show 1 minute, and the oven will immediately begin cooking.

The **Cook** indicator will light, the oven will begin cooking and the display will count down the remaining cooking time.













When the **Express Cook** time ends, you will hear 5 beeps. The display will show "End."

BEEPER VOLUME

You may adjust the beeper volume to one of three levels or mute by pressing the up and down pads.



When the oven is first plugged in, the beeper volume will automatically set itself at the maximum or loudest level. Each touch of the  pad will reduce the volume and then mute the beeper. Each touch of the  pad will stop the mute feature and then increase the beeper volume. Each time the  or  pad is pressed the oven will beep at the selected volume level. There will be no beeper sound when mute is selected.

When plugged in.	Maximum 	Push  three times.
Push  once.	Medium 	Push  twice.
Push  twice.	Quiet 	Push  once.
Push  three times.	Mute	

TO STOP THE OVEN WHILE IT IS OPERATING

1. Press the Clear/Off pad.
 - The Pause indicator will start blinking.
 - The oven can be restarted by pressing the Start/Pause pad.
 - Touch the Clear/Off pad one more time to erase all instructions.
 - You must enter new instructions.
2. Open the door.
 - You can restart the oven by closing the door and touching the Start/Pause pad.

CHARGER AND REAR OUTLETS

Use one or both of the two convenient 120 VAC outlets located on the front of the oven to charge cell phones, digital cameras, i-Pods, laptops or similar low power devices. The outlets are limited to 4 AMPS or 480 Watts maximum.

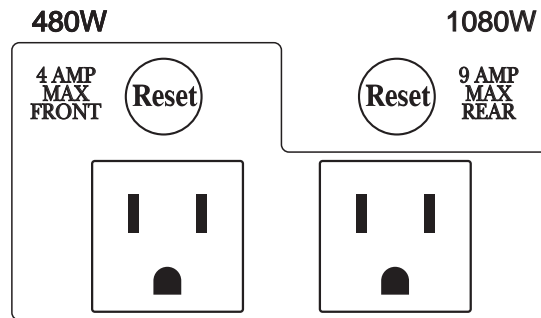

A) Charger Outlets Operation

1. **Charger Outlets are always active unless the microwave is running.**
2. **Each Charger Outlet is monitored for load; loads in excess of 4.0 amperes or 480 Watts will cause the corresponding Charger Outlet to become inactive.**
3. **Once the Charger Outlet has become inactive due to excessive load, the user must unplug the load and press the associated Charger Reset button one time to restore power to the Charger Outlet. Do not hold or tape the Charger Reset button in the down position.**

B) Charger Lamp Operation

1. **When the Charger Outlet is active (AC power at the outlet), the Charger Lamp is ON.**
2. **When the Charger Outlet is inactive (No AC Power at the outlet), the Charger Lamp is OFF.**
3. **When the Charger Outlet is inactive due to the microwave operation, the Charger Lamp will flash.**

WARNING: Be careful not to entrap any charger cords in the microwave door.

AjMadison
Your Appliance Authority™

800-570-3355

**MicroFridge® with Safe Plug®, a Product of INTIRION Corporation
Microwave Oven and Refrigerator/Freezer Residential Limited Warranty**

INTIRION is pleased to provide a comprehensive warranty on these products. INTIRION takes pride in its product and manufacturing standards and warrants its products and parts against defects in materials or workmanship to the original purchaser.

<u>Subassembly</u>	<u>Duration</u>
- Microwave oven magnetron	2 years
- Refrigerator/freezer sealed system and compressor	2 years
- Microwave oven and refrigerator/freezer mechanical components	1 year

All requests for service should be directed to Customer Service at INTIRION by calling 1-800-637-7567. INTIRION offers a quick response customer service program. Customer service will diagnose the problem and either replace or the original purchaser will carry-in the appliance to an **authorized service provider** for repair, at the discretion of INTIRION.

MicroFridge® with Safe Plug® warranty services are performed by INTIRION **authorized service providers**. INTIRION expects prompt, courteous and efficient service. INTIRION further expects that all **authorized service providers** will make every reasonable effort to enhance the image and reputation of INTIRION and its products. Inadequate service or customer dissatisfaction should be promptly reported to INTIRION.

Damage initiated by spark fires caused by using inappropriate material inside the microwave oven is specifically excluded from this warranty. INTIRION assumes no liability and does not guarantee or warrant any repairs and/or replacement parts not supplied or performed by an **authorized service provider**, nor any 50/60 cycle or 60/50 cycle conversions, damage caused by failure to follow the owner's manual as to adjustments and/or maintenance, customer adjustments that are not covered in the instruction booklet, broken or marred cabinet, misuse, neglect, accident, fire, flood or other acts of nature.

THIS WARRANTY WILL BECOME INVALID IF ANY SERIAL NUMBER ON THE PRODUCT IS ALTERED, REPLACED, DEFACED OR MISSING. THIS WARRANTY IS FOR INTIRION PRODUCTS PURCHASED AND USED IN THE UNITED STATES EXCEPT FOR UNITED STATES POSSESSIONS AND/OR DOMINIONS OF THE UNITED STATES.

This is the entire INTIRION warranty and it may not be changed or amended by any person, agency, distributor, dealer, or company. INTIRION assumes no liability and indeed specifically denies responsibility for any consequential damages beyond the repair or replacement of the product or its components.

The warranty period begins on the date of sale and proof of that date (evidenced by an original sales slip or bill of sale) will be necessary to initiate a warranty claim.

MICROFRIDGE® WITH SAFE PLUG®, A PRODUCT OF INTIRION CORPORATION, 2 Annette Road, Suite 3, Foxborough, MA 02035 **1-800-637-7567**



**For your protection in the event of theft or loss of this product,
please fill in the information below:**

Model No. _____
(Located on cavity front)

Serial No. _____
(Located on cavity front)

Date of Purchase _____

INTIRION™
2 Annette Road, Suite 3
Foxborough, MA 02035
1-800-637-7567

11/11 Printed in China