



**PREMIUM DOUBLE DRAWER  
OUTDOOR RATED REFRIGERATOR  
MODEL # 17400  
OWNERS MANUAL**



**BEFORE INSTALLATION OR USE, PLEASE READ AND  
FOLLOW ALL SAFETY RULES AND OPERATING INSTRUCTIONS**

*Write Serial No. in box below for future reference*

Serial No. _____
------------------



## **TABLE OF CONTENTS**

## **PAGE NO.**

### **GETTING STARTED**

- PRODUCT REGISTRATION INSTRUCTIONS 3
- PRODUCT SERIAL NUMBER LOCATIONS 3
- APPLIANCE SAFETY AND IMPORTANT SAFEGUARDS 4

### **INSTALLATION**

- SITE PREPARATION 5
- ANTI-TIP BRACKET INSTALLATION 5-6
- LEVELING THE UNIT 6
- INSTALLING DRAWER HANDLES 6
- ELECTRICAL AND PLUMBING CONNECTION 7
- EXTENSION CORD 7

### **OPERATING YOUR REFRIGERATOR:**

- CONTROL PANEL 8

### **CARE AND MAINTENANCE:**

- CLEANING AND MAINTENANCE 8
- POWER FAILURE 9
- VACATION TIME (OFF-SEASON SET-UP) 9
- MOVING YOUR REFRIGERATOR 9
- ENERGY SAVING TIPS 9

### **TROUBLESHOOTING** 10

### **HOW TO ORDER REPLACEMENT PARTS** 11

### **PARTS LIST AND ILLUSTRATION** 11

### **WARRANTY INFORMATION** 12-14



**WARNING:** THIS PRODUCT CAN EXPOSE YOU TO CHEMICALS INCLUDING CARBON MONOXIDE, WHICH IS KNOWN TO THE STATE OF CALIFORNIA TO CAUSE BIRTH DEFECTS OR OTHER REPRODUCTIVE HARM. FOR MORE INFORMATION VISIT [www.P65Warnings.ca.gov](http://www.P65Warnings.ca.gov)



## REGISTERING YOUR REFRIGERATOR

Thank you for purchasing your Bull Outdoor Products Refrigerator. To validate your Limited Warranty, you must submit the completed the Warranty Registration Form within 90 days from the date of purchase. Registration can be completed on-line at <https://www.bullbbg.com/warranty/product> or by sending the completed Warranty Registration Form and copy of your Purchase Receipt or Invoice as proof of purchase to:

**BULL OUTDOOR PRODUCTS, INC.**  
 1011 East Pine St.  
 Lodi, CA 95240  
 Attn: Warranty Service Center

For Warranty Claims or Replacement Parts ordering, please fill out the area provided below:

### PRODUCT INFORMATION REFERENCE CARD

1) Model Number \_\_\_\_\_

2) Serial Number \_\_\_\_\_

(The Serial Number is encoded with essential information for ordering replacement parts or submitting Warranty claims. Location of Serial Numbers is shown below)

3) Date of Purchase \_\_\_\_\_

4) Copy of your Purchase Receipt or Invoice.

For Warranty Questions call Customer Service at (800) 521-2855

## LOCATION OF SERIAL NUMBER

Essential information about your product is encoded in the serial number. This information will be required for all warranty claims, ordering replacement parts and will identify any variations of your unit. It is extremely important that you record your serial number and register your grill from the Proof of Purchase. The Serial number info can be found in the locations shown below:

The serial number info is on the top and on each side of the box it was shipped in.

Model# -   
 UPC# -   
 Serial# -





**GRILL FOR GOO**



Model# -   
 UPC# -   
 Serial# -  
 Product Identification# -

\*Caution - Risk of Fire or Explosions to Flammable Refrigerant Used. Follow Handling Instructions Carefully in Compliance With U.S. and Canada Government Regulations\*

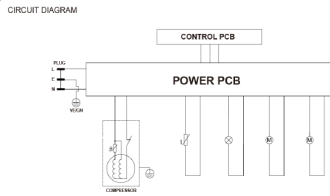
The data plate on the back of the unit also shows the serial number.

		 <b>Premium Double Drawer Fridge 17400</b> <b>Designed Pressure</b> <table border="1"> <tr><td>High Side</td><td>220 PSI</td></tr> <tr><td>Low Side</td><td>43 PSI</td></tr> <tr><td>Refrigerant</td><td>R600a</td></tr> <tr><td>Charge</td><td>0.88 Ounce</td></tr> <tr><td>Rated Voltage</td><td>AC 115V/1PH/60HZ</td></tr> <tr><td>Rated Current</td><td>1.3 A</td></tr> </table>	High Side	220 PSI	Low Side	43 PSI	Refrigerant	R600a	Charge	0.88 Ounce	Rated Voltage	AC 115V/1PH/60HZ	Rated Current	1.3 A
High Side	220 PSI													
Low Side	43 PSI													
Refrigerant	R600a													
Charge	0.88 Ounce													
Rated Voltage	AC 115V/1PH/60HZ													
Rated Current	1.3 A													
Serial:														
Product Identification:														
		 <b>Intertek 4006961</b> <small>CONFORMS TO UL STD. 60335-1 &amp; 60335-2-24        CERTIFIED TO CSA STD. C22.2# NO. 60335-1 &amp; 60335-2-24</small>												



## APPLIANCE SAFETY AND IMPORTANT SAFEGUARDS

### APPLIANCE SAFETY

**Your safety and the safety of others is very important.**

We have provided many safety messages in this manual and on your appliance. Always read and obey all safety messages.



This is the Safety Alert Symbol. This symbol alerts you to potential hazards that can injure or kill you and others. All safety messages will follow the Safety Alert Symbol with the word 'DANGER' or 'WARNING'



'DANGER' means that failure to heed this safety statement may result in severe personal injury or death.



'WARNING' means that failure to heed this safety statement may result in extensive product damage, severe personal injury or death.

All safety messages will alert you about the potential hazard, tell you how to reduce the chance for injury and let you know what can happen if the instructions are not followed.

### IMPORTANT SAFEGUARDS



Before the appliance is used, it must be properly positioned and installed as described in this manual, so read the manual carefully to reduce the risk of fire, electrical shock or injury when using the appliance by following the basic precautions below: Electrical cord for Refrigerator must be plugged into a 3 prong outlet.

- Do not remove grounding prong.
- Do not use an adapter or extension cord.
- It is recommended your Refrigerator be powered by a separate circuit dedicated only to your appliance.
- Use a receptacle that cannot be turned off by a switch or pull-chain.
- Do not connect or disconnect the electric plug when your hands are wet.
- Unplug the appliance or disconnect power before cleaning or servicing. Failure to do so can result in electrical shock or death.
- Never clean appliance parts with flammable liquids. These liquids have fumes that can create a fire or explosion hazard.
- Do not store or use gasoline or other liquids with flammable vapors in the vicinity of the or any other appliance that can create a fire or explosion hazard.
- Do not attempt to repair or replace any part of your appliance unless it is specifically recommended in this manual. All other servicing should be referred to a qualified technician.

### INSTALLATION INSTRUCTIONS

#### BEFORE INSTALLING YOUR APPLIANCE

- Remove the exterior and interior packing.
- Before connecting the appliance to the power source, let it stand for approximately 24 hours. This will reduce the possibility of a malfunction in the cooling system from handling during transportation.
- Clean the interior surface with lukewarm water using a soft cloth.
- Install the handle to the door if needed.

#### INSTALLING YOUR APPLIANCE

- Your outdoor double drawer refrigerator has been designed for built-in or free standing use.
- For built-in use, the front grill must **not** be obstructed.
- No air space is required for the top, side or rear.

#### NOTE:

- It is recommended that you do not install the appliance near an oven, radiator or other heat source as it may increase appliance electrical consumption.
- Do not install in a location where the temperature will below 50 degrees Fahrenheit, or in a moist area.
- For best performance, do not install behind a cabinet door or in a manner that obstructs the front grill.
- Plug the appliance into a dedicated, properly grounded wall outlet



#### RISK OF CHILD ENTRAPMENT

Child entrapment and suffocation are not problems of the past. Junked or abandoned appliances are still dangerous, so please do the following before discarding your old refrigerator:

- 1) Take off the doors or drawers.
- 2) Leave shelves in place so children may not easily climb inside.

### SAVE THESE INSTRUCTIONS



## SITE PREPARATION

- 1) Position the unit on a flat, level surface capable of supporting the entire weight of the unit. Note that your Refrigerator will be significantly heavier once it is fully loaded. Before filling, wipe out inside of unit with a damp cloth.
- 2) Position the unit to allow free air flow through the front grill as shown below

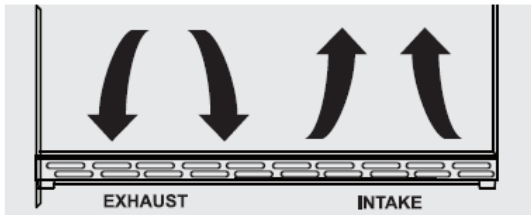

- 3) The Refrigerator must be installed according your local codes and ordinances.

### 4) **ELECTROCUTION HAZARD!**



Electrical Grounding Required – This appliance is equipped with a 3 prong (grounding) polarized plug for your protection against possible shock hazards.

- NEVER remove the grounding prong from the plug.
- NEVER use a 2 prong grounding adapter.
- NEVER use an extension cord connect power to the unit.

**Where a 2 prong wall receptacle is encountered or a longer power cord is Required, contact a qualified electrician to have it replaced in accordance with Applicable electrical codes.**

- 5) Be sure to install the Anti-Tip bracket using the kit provided. Please note safety concerns below.

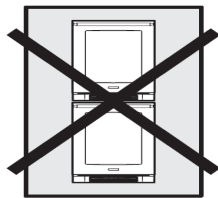

## ANTI-TIP BRACKET INSTALLATION

Your Refrigerator comes with an Anti-Tip Bracket that must be properly installed per instructions below to reduce the risk of tip over due to abnormal use or improper loading.

### STEP 1 Per Figure 1,

- Place the Anti-Tip brackets on the floor with the intention of mounting the brackets to hold the refrigerator from the back side.
- Mark the location of the 4 holes for one of the brackets on the floor.
- Mark the location for the mounting holes of the 2<sup>nd</sup> bracket. Insure slots on centers of bracket line up with leveling feet on fridge.
- Use a 5/16 masonry drill bit and insert the plastic anchors
- Secure bracket to floor using screws.

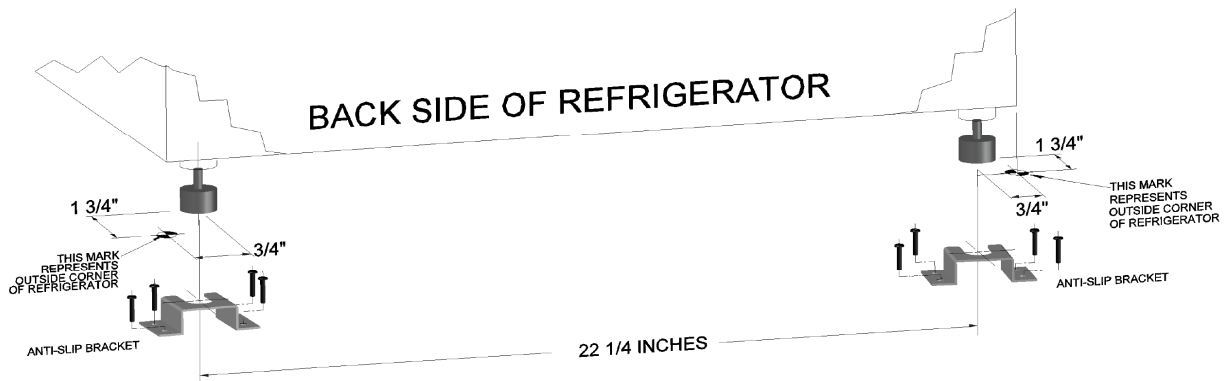

Figure 1



## ANTI-TIP BRACKET INSTALLATION (CONTINUED)

### STEP 2

- Lift the bottom of the unit as shown below.
- Use a screwdriver to remove the screws indicated next to the leveling feet. This enables you to adjust the leveling feet. Note, to prevent the leveling feet from falling out of their mounts, do not loosen the leveling feet distance more than 1/8 inch.

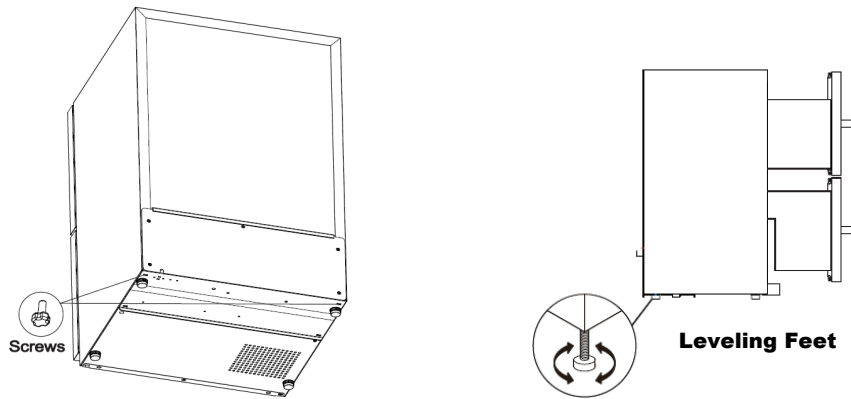

### STEP 3

- Slide the leveling feet of the refrigerator into anti-tip brackets for final positioning as shown below.

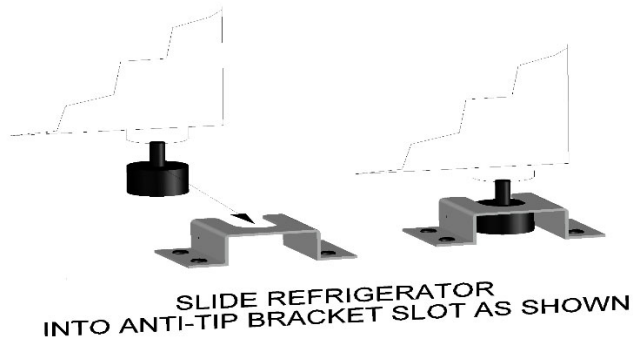

**IMPORTANT!** Do not use Refrigerator without the Anti-Tip Bracket in place.

### LEVELING YOUR REFRIGERATOR

Position the unit on a flat level surface capable of supporting the entire weight of the unit when full. This unit contains 4 adjustable leveling feet. Turn clockwise to raise and counterclockwise to lower.

### INSTALLING THE DRAWER HANDLES

Use provided screws to install finger tight and verify handle lines up straight to drawer before tightening with screw driver per figure shown.

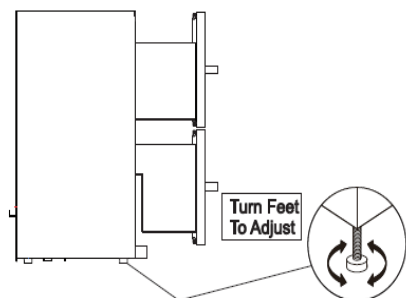
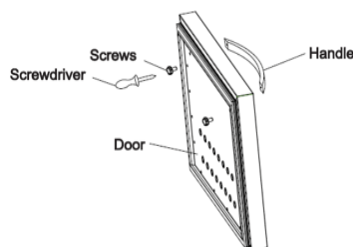

## ELECTRICAL /PLUMBING

## CONNECTIONS



		<p>Premium Double Drawer Fridge 17400</p> <table border="1"> <tr><th colspan="2">Designed Pressure</th></tr> <tr><td>High Side</td><td>220 PSI</td></tr> <tr><td>Low Side</td><td>43 PSI</td></tr> <tr><td>Refrigerant</td><td>R600a</td></tr> <tr><td>Charge</td><td>0.88 Ounce</td></tr> <tr><td>Rated Voltage</td><td>AC 115V/1PH/60HZ</td></tr> <tr><td>Rated Current</td><td>1.3 A</td></tr> </table>	Designed Pressure		High Side	220 PSI	Low Side	43 PSI	Refrigerant	R600a	Charge	0.88 Ounce	Rated Voltage	AC 115V/1PH/60HZ	Rated Current	1.3 A
Designed Pressure																
High Side	220 PSI															
Low Side	43 PSI															
Refrigerant	R600a															
Charge	0.88 Ounce															
Rated Voltage	AC 115V/1PH/60HZ															
Rated Current	1.3 A															
Serial:																
Product Identification:																
		<p>CONFORMS TO UL STD. 60335-1 &amp; 60335-2-24 CERTIFIED TO CSA STD. C22.2# NO. 60335-1 &amp; 60335-2-24</p>														

**! WARNING**

Improper use of the grounded plug can result in the risk of electrical shock. If the power cord is damaged, have it replaced by a qualified electrician or an authorized service center.

This appliance should be properly grounded for your safety. The power cord of this appliance is equipped with a three-prong plug which mates with standard three-prong wall outlets to minimize the possibility of electrical shock.

Do not under any circumstances cut or remove the third (ground) prong from the power cord supplied. For personal safety, this appliance must be properly grounded. Any questions concerning power and/or grounding should be directed toward a certified electrician or an authorized service center.

This appliance requires a standard 115/120 Volt AC ~60Hz three-prong grounded electrical outlet. Have the wall outlet and circuit checked by a qualified electrician to make sure the outlet is properly grounded. When a standard 2-prong wall outlet is encountered, it is your responsibility and obligation to have it replaced with a properly grounded 3-prong wall outlet.

To prevent accidental injury, the cord should be secured behind the appliance and not left exposed or dangling.

The appliance should always be plugged into its own individual electrical outlet which has a voltage rating that matches the rating label on the appliance. This provides the best performance and also prevents overloading house wiring circuits that could cause a fire hazard from overheating. Never unplug the appliance by pulling on the power cord. Always grip the plug firmly and pull straight out from the receptacle. Repair or replace immediately all power cords that have become frayed or otherwise damaged. Do not use a cord that shows cracks or abrasion damage along its length or at either end. When moving the appliance, be careful not to damage the power cord.

**! WARNING**

**FOLLOW WARNING CALL OUTS BELOW ONLY WHEN APPLICABLE TO YOUR MODEL**  
Use two or more people to move and install appliance. Failure to do so can result in back or other injury.

To ensure proper ventilation for your appliance, the front of the unit must be completely unobstructed. Choose a well-ventilated area with temperatures above 50°F (10°C) and below 109.4°F (43°C).

The appliance should not be located next to ovens, grills or other sources of high heat.

The appliance must be installed with all electrical, water and drain connections in accordance with state and local codes. A standard electrical supply (115 V AC only, 60 Hz), properly grounded in accordance with the National Electrical Code and local codes and ordinances, is required.

Do not kink or pinch the power supply cord of the appliance.

The size of the fuse (or circuit breaker) should be 1.3 amperes.

It is important that the appliance be leveled in order to work properly. You may need to make several adjustments to level it.

All installations must be in accordance with local plumbing code requirements.

Make certain that the pipes are not pinched, kinked or damaged during installation.

Check for leaks after connection.

Never allow children to operate, play with or crawl inside the appliance.

Do not use solvent-based cleaning agents or abrasives on the interior. These cleaners may damage or discolor the interior.

Use this appliance only for its intended purpose as described in this *Instruction Manual*.

Keep fingers out of the "pinch point" areas. Clearances between the door and cabinet are necessarily small. Be careful closing door when children are in the area.

**EXTENSION CORD**

Because of potential safety hazards under certain conditions, it is strongly recommended that you do not use an extension cord with this appliance. However, if you must use an extension cord it is absolutely necessary that it be a UL/CUL-Listed, 3-wire grounding type appliance extension cord having a grounding type plug and outlet and that the electrical rating of the cord be 115 volts and at least 1.3 amperes.



## OPERATING YOUR APPLIANCE

It is recommended that you install the appliance in a place where the ambient temperature is between 50°F and 109.4°F (10°C- 43°C). If the ambient temperature is above or below recommended temperatures, the performance of the unit may be affected. For example, placing your unit in extremely cold or hot conditions may cause interior temperatures to fluctuate. The operating temperature range may not be reached.

Each wine cellar includes an operating panel on the front of the unit. This operating panel includes several features to operate and control the temperature.

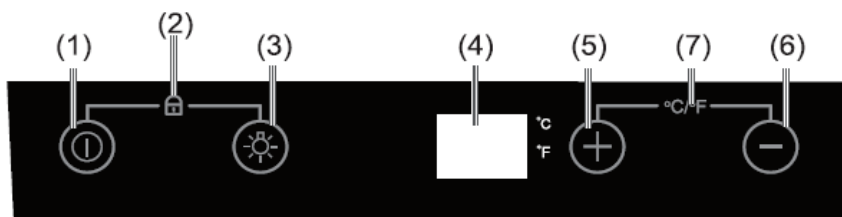

1. Press and hold to turn the Power ON and OFF
2. Press and hold simultaneously to Unlock and Lock the Control Panel
3. Turns the Interior Light ON and OFF
4. Displays the Temperature
5. Increases Set Temperature 1°F with Each Push
6. Decreases Set Temperature 1°F with Each Push
7. Press and hold simultaneously to Alter the Temperature Display to Fahrenheit or Celsius

## CARE AND MAINTENANCE

### CLEANING AND MAINTAINING YOUR REFRIGERATOR

Periodic cleaning and proper maintenance will ensure efficiency, top performance, and long life. The maintenance intervals listed are based on normal conditions. You may want to shorten the intervals if you have pets or other special considerations.

#### Exterior Cleaning for Your Stainless Steel Model

- Your stainless steel model may discolor when exposed to chlorine gas, pool chemicals, salt water, or cleaners with bleach.
- Keep your stainless unit looking new by cleaning with a high quality, all-in-one stainless steel stainless steel cleaner/polish on a monthly basis. Frequent cleaning will remove surface contamination that could lead to rust. Some installations will require cleaning on a weekly basis.
- DO NOT CLEAN WITH STEEL WOOL PADS.
- DO NOT USE CLEANERS THAT ARE NOT SPECIFICALLY INTENDED FOR STAINLESS STEEL (this includes glass, tile and counter cleansers).
- If any surface discolors or rusting appears, clean it quickly with Bon-Ami or Barkeepers Friend Cleanser and a non-abrasive cloth. Always clean in the direction of the grain. Always finish this process with a high quality, all-in-one stainless steel cleaner/polish to prevent further problems.
- USE OF ABRASIVE PADS SUCH AS SCOTCHBRITE WILL CAUSE THE GRAINING IN THE STAINLESS TO BECOME BLURRED.
- Rust that is allowed to linger can penetrate into the surface of the stainless steel and become impossible to remove.





### **POWER FAILURE**

Most power failures are corrected within a few hours and should not affect the temperature of your appliance if you minimize the number of times the door is opened. If the power is going to be off for a longer period of time, you need to take the proper steps to protect the contents.

### **VACATION TIME**

**Short vacations:** Leave the appliance operating during vacations of less than three weeks.

**Long vacations:** If the appliance will not be used for several months, remove all items and turn off the appliance. Clean and dry the interior thoroughly. To prevent odor and mold growth, leave the door open slightly, blocking it open if necessary.

### **MOVING YOUR APPLIANCE**

1. Remove all items.
2. Securely tape down all loose items (shelves) inside your appliance.
3. Turn the adjustable legs up to the base to avoid damage.
4. Tape the door shut.
5. Be sure the appliance stays secure in the upright position during transportation. Also protect the outside of the appliance with a blanket or similar item.

### **ENERGY SAVING TIPS**

The appliance should be located in the coolest area of the room or outdoor location, away from heat-producing appliances and out of direct sunlight.

Ensure that the unit is adequately ventilated. Never cover air vents.

Do not keep the door open any longer than necessary.

Let hot foods cool to room temperature before placing in the unit. Overloading the unit forces the compressor to run longer.

Be sure to wrap foods properly, and wipe containers dry before placing them in the unit. This cuts down on frost build up inside the unit.

Unit shelves and storage bins should not be lined with aluminum foil, wax paper or paper toweling. Liners interfere with cold air circulation, making the unit less efficient.

Organize and label stored items to reduce door openings and extended searches. Remove as many items as needed at one time, and close the door as soon as possible.



## TROUBLESHOOTING

You can solve many common problems easily, saving you the cost of a possible service call. Try the suggestions below to if you can solve the problem before calling for help.

### Troubleshooting Guide

PROBLEM	POSSIBLE CAUSE	REMEDY
Appliance does not operate.	<ul style="list-style-type: none"> <li>* Appliance is not connected to power supply.</li> <li>* The appliance is turned off.</li> <li>* The power supply has a tripped circuit breaker or blown fuse.</li> </ul>	<ul style="list-style-type: none"> <li>* Connect the appliance</li> <li>* Turn on the appliance</li> <li>* Switch on circuit breaker or replace fuse</li> </ul>
Appliance is not cold enough.	<ul style="list-style-type: none"> <li>* The temperature is not set correctly.</li> <li>* The ambient temperature could require a lower temperature setting.</li> <li>* The drawer was opened too often.</li> <li>* The drawer was not closed completely.</li> <li>* Drawer is not hermetically sealed.</li> <li>* The condenser is too dirty.</li> <li>* The ventilation opening to blocked or too dusty.</li> </ul>	<ul style="list-style-type: none"> <li>* Check the set temperature.</li> <li>* Set a lower temperature.</li> <li>* Do not open the drawer more often than necessary.</li> <li>* Close the door properly.</li> <li>* Check the door seal and clean or replace.</li> <li>* Clean the condenser when necessary.</li> <li>* Clear the obstructions and clean the dust</li> </ul>
Appliance turns itself on and off frequently.	<ul style="list-style-type: none"> <li>* The room temperature is higher than average.</li> <li>* A large amount of food has been added to the unit.</li> <li>* One of the drawers is open too often.</li> <li>* The drawer is not closed completely.</li> <li>* The drawer gasket does not close seal properly.</li> </ul>	<ul style="list-style-type: none"> <li>* Check the set temperature.</li> <li>* Set a lower temperature.</li> <li>* Do not open the drawer more often than necessary.</li> <li>* Close the door properly.</li> <li>* Check the door seal and clean or replace.</li> <li>* Clean the condenser when necessary.</li> <li>* Clear the obstructions and clean the dust</li> </ul>
Vibrations or Excessive noise.	<ul style="list-style-type: none"> <li>* The appliance is not properly leveled.</li> <li>* Noises such as rattling.</li> <li>* If temperature fluctuations occur, the contraction and expansion of the inner walls may cause popping and cracking noises.</li> </ul>	<ul style="list-style-type: none"> <li>* Level the appliance with the adjustable feet.</li> <li>* These noises are normal and may come from the flow of the refrigerant which is normal. As each refrigeration cycle ends, you may hear gurgling sounds caused by the flow of refrigerant in your appliance.</li> </ul>
The drawer will not close properly	<ul style="list-style-type: none"> <li>* The appliance is not properly leveled.</li> </ul>	<ul style="list-style-type: none"> <li>* Level the appliance with the adjustable feet.</li> <li>* Check the door hinge and reassemble correctly.</li> <li>* Clean the door gasket.</li> <li>* Check the drawers and refit correctly.</li> </ul>
The alarm sounds and the temperature display flashes.	<ul style="list-style-type: none"> <li>* Has the appliance door been open for longer than 60 second?</li> <li>If not, then the temperature has risen higher or lower than the temperature that has been set.</li> <li>This could be due to:               <ul style="list-style-type: none"> <li>* The appliance door being opened too often.</li> <li>* The ventilation opening being covered or too dusty.</li> <li>* A lengthy interruption in the power supply.</li> <li>* A large amount of food has been added to the unit.</li> </ul> </li> </ul>	<ul style="list-style-type: none"> <li>* If yes, close the door.</li> <li>* Do not open the door more often than necessary.</li> <li>* Clear the obstructions and clean the dust</li> <li>* Leave the appliance to work for a while until the set temperature has been reached.</li> </ul>



## HOW TO ORDER REPLACEMENT PARTS

This is where your Product Information Reference Card will come in handy for supplying necessary info needed by your Bull Authorized Dealer to assure you get the correct part(s) for your refrigerator or additional accessories to keep your refrigerator in top working condition. If you don't have the card, you can still get the model number and serial number on the inside of the left side panel. That information is required for parts orders.

**Please refer to your owner's manual parts list and illustration to identify what you need.**

**To Order Replacement Parts on-line go to:** <https://www.bullbbq.com/buy-parts>

**Ordering Parts by phone:**

Bull is ready to help with two regional suppliers open 8:00 am to 5:00 pm Monday through Friday.

For the Western Region, call (800) 258-6810

For the Eastern Region, call (800) 229-3056

**INSPECT YOUR SIDE CART FOR ANY DAMAGE AND CONTACT OUR SERVICE CENTER OR LOCAL DEALER FOR REPLACEMENT OF ANY DAMAGED PARTS.**

**IF DAMAGED DO NOT ATTEMPT INSTALLATION.**

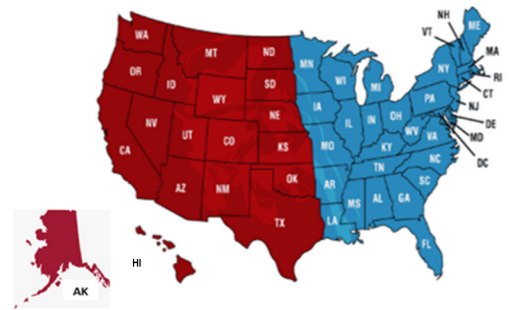

West Region

East Region

## REPLACEMENT PARTS LIST AND ILLUSTRATION:

17400 DOUBLE DRAWER REFRIGERATOR REPLACEMENT PARTS LIST			
ILLUSTRATION NUMBER	BULL PART NUMBER	DESCRIPTION	QUANTITY
1	12219	LIGHT SWITCH	2
2	12106	EVAPORATOR FAN	1
3	12103	DIGITAL CONTROLLER	1
4	12109	EVAPORATOR FAN COVER	1
5	12120	KICK PLATE	1
6	12116	FOOT	4
7	12125	CONDENSER FAN	1
8	12114	BACK GRILL	1
9	12126	DOOR GASKET	2
10	12132	LEFT AND RIGHT GUIDE RAIL	4
11	12129	DRAWER HANDLE	2
12	12130	BOTTOM DRAWER	1
13	12138	BOTTOM DRAWER FRONT PANEL	1
14	12132	BOTTOM DRAWER DIVIDER	1
15	12127	TOP DRAWER	1
16	12139	TOP DRAWER FRONT PANEL	1
17	12128	TOP DRAWER DIVIDER	1

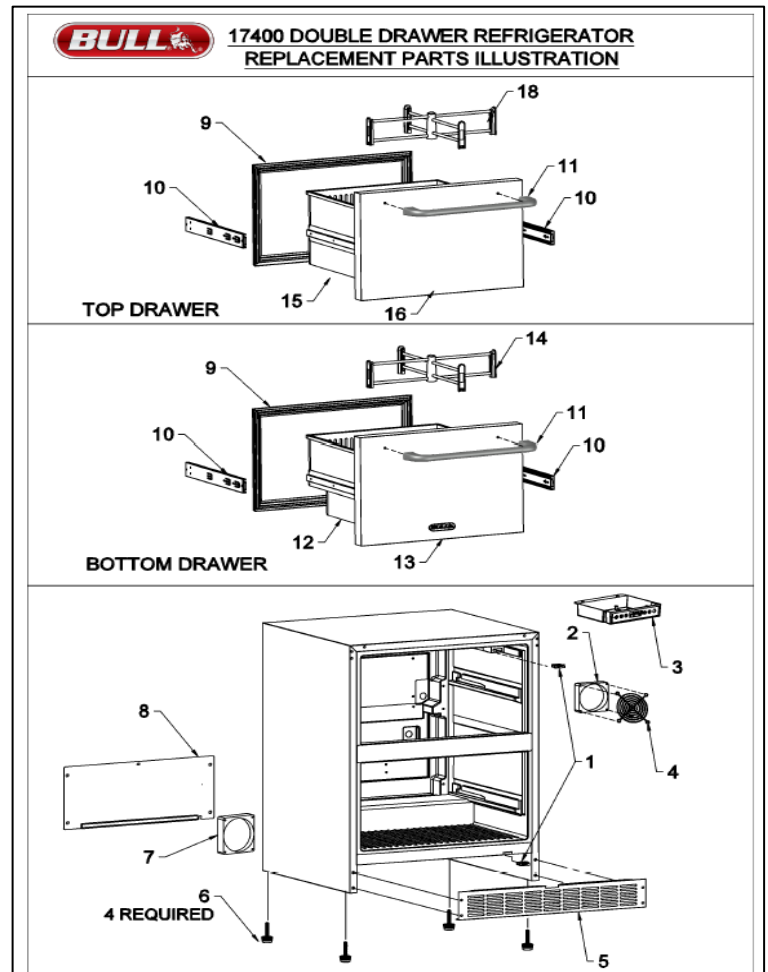

**WARNING:** Use of any part that is not factory authorized will void your warranty and may be dangerous.



## Warranty Policy

**LIMITED WARRANTY ON BULL OUTDOOR PRODUCTS, INC., PRODUCTS**

**THIS LIMITED WARRANTY GIVES YOU SPECIFIC LEGAL RIGHTS. YOU MAY ALSO HAVE OTHER RIGHTS, WHICH VARY FROM STATE TO STATE.**

**THIS LIMITED WARRANTY CAN ALSO BE FOUND ON OUR WEB SITE AT:**

<https://www.bullbbq.com/support-warranty> (United States Customers);

<https://www.bullbbq.eu/en/warrantyform.htm> (International Customers)

**AND IN THE OWNER'S/INSTALLATION MANUAL THAT WE PROVIDE WITH OUR PRODUCT.**

**THIS LIMITED WARRANTY IS SUBJECT TO THE EXCLUSIONS, CONDITIONS AND LIMITATIONS SET FORTH BELOW.**

**ANY IMPLIED WARRANTIES IMPOSED BY LAW, INCLUDING WITHOUT LIMITATION THE IMPLIED WARRANTIES OF MERCHANTABILITY AND FITNESS FOR A PARTICULAR PURPOSE, ARE LIMITED IN DURATION TO THE DURATION OF THIS EXPRESS LIMITED WARRANTY. SOME STATES DO NOT ALLOW LIMITATIONS ON HOW LONG AN IMPLIED WARRANTY LASTS, SO THE ABOVE LIMITATION MAY NOT APPLY TO YOU.**

**WHO MAY USE THIS WARRANTY?**

BULL OUTDOOR PRODUCTS, INC. located at address 1011 East Pine St. Lodi, CA. 95240

("we") extend this limited warranty only to the consumer who originally purchased the product ("you") at the original site of delivery or installation. It does not extend to any subsequent owner or other transferee of the product. It does not apply to products installed in any rental, commercial or non-residential application. Examples of excluded applications include, but are not limited to day care centers, schools, bed and breakfast centers, churches, private clubs, fire stations, club houses, common areas in multi-family dwellings, restaurants, hotels, nursing homes, food service locations and institutional food service locations.



## WHAT DOES THIS WARRANTY COVER?

This limited warranty covers defects in materials and workmanship of the product and product components identified below for the Warranty Periods defined below.

## WHAT IS THE PERIOD OF COVERAGE?

This limited warranty starts on the date of your purchase and lasts for the time period or time periods specified above (the "**Warranty Period**"). The Warranty Period is not extended if we repair or replace the product. We may change the availability of this limited warranty at our discretion, but any changes will not be retroactive.

- **Grill Warranty Periods**

The following parts are covered for **one year** on all our current gas grill models:

The lid, control panel, grease tray, bezels, knobs, temperature gauge, valves, regulator, flex tubes, rotisserie burner, transformer, and all components of the lighting system.

The following parts are covered for **three years** on all our current gas grill models:

The manifold, handle end caps, flame tamers, heat shields, and warming rack.

The following parts are covered for **lifetime** on all our current gas grill models:

Insert assembly and the grates.

The warranty period for the grill burners vary by type:

Cast stainless steel burners - **lifetime**,

Welded burners - **5 years**, and

Porcelain coated burners - **3 years**.

The warranty period for the charcoal grill is **one year** on all parts, except for the insert assembly, which is covered for **5 years**.

The Bel Air grill included a **one-year** warranty on all parts.

- **Component Warranty Periods**

All of the parts for our components/grill carts/refrigerators/kegerators/drawers/doors are covered for **one year** with these exceptions:

Power Burner

- The insert/grates are **lifetime** covered parts.
- The manifold/burner are covered for **3 years**.

Searing Station/Slide in Double Sideburner

- The grates are covered for **lifetime**,
- the insert for **5 years**, and
- the manifold for **3 years**.

Single Sideburner

- The grates are covered for **5 years** and
- the burner for **3 years**.

Sidekick

- The burner is covered for **3 years**.

- **Pizza Ovens/Islands/Fire Features Warranty Periods**

All of the parts and construction materials are covered for **one year**.

Grill Accessories and Grill Covers do not include a warranty period.



## Warranty Policy (Continued)

### **WHAT DOES THIS WARRANTY NOT COVER?**

This limited warranty does not cover any damage due to: (a) transportation; (b) storage; (c) improper installation or use; (d) use on improper fuel/gas supply; (e) failure to follow the product instructions or to perform any preventive maintenance; (f) modifications; (g) unauthorized repair; (h) normal wear and tear; or (i) external causes such as accidents, abuse, or other actions or events beyond our reasonable control.

### **WHAT ARE YOUR REMEDIES UNDER THIS WARRANTY?**

With respect to any defective product claim made during the Warranty Period, we will, in our sole discretion, either: repair or replace such product (or the defective part) free of charge or (b) refund the purchase price of such product. We will not pay for shipping charges for repaired or replacement parts, or for any labor or labor related charges. We will not pay for any accessory products or ancillary products purchased by you for use in connection with the product.

### **HOW DO YOU OBTAIN WARRANTY SERVICE?**

To obtain warranty service, you must submit a warranty claim online through the Bullbq.com website during the Warranty Period. Warranty claims will not be accepted via email, fax or phone.

### **LIMITATION OF LIABILITY**

**THE REMEDIES DESCRIBED ABOVE ARE YOUR SOLE AND EXCLUSIVE REMEDIES AND OUR ENTIRE LIABILITY FOR ANY BREACH OF THIS LIMITED WARRANTY. OUR LIABILITY SHALL UNDER NO CIRCUMSTANCES EXCEED THE ACTUAL AMOUNT PAID BY YOU FOR THE DEFECTIVE PRODUCT, NOR SHALL WE UNDER ANY CIRCUMSTANCES BE LIABLE FOR ANY CONSEQUENTIAL, INCIDENTAL, SPECIAL OR PUNITIVE DAMAGES OR LOSSES, WHETHER DIRECT OR INDIRECT.**

**SOME STATES DO NOT ALLOW THE EXCLUSION OR LIMITATION OF INCIDENTAL OR CONSEQUENTIAL DAMAGES, SO THE ABOVE LIMITATION OR EXCLUSION MAY NOT APPLY TO YOU.**

Revised 10-15-2020 APR