



2025 STANDARD PRICE LIST EFFECTIVE OCTOBER 1, 2024

These prices (in United States dollars) are effective October 1, 2025, and apply to the sale of any WEBER brand products by Weber to an authorized retailer ("Dealers") and supersede any previous prices. All prices are subject to change by Weber for any reason with thirty (30) days written notice. Weber reserves the right to refuse to sell any products or extend credit for any reason. Weber requires that Dealers resell **WEBER** products only to consumers at Dealer's retail location(s) within the United States. As a condition of sale, Weber (i) prohibits any sales by a Dealer of **WEBER** products on Internet auction sites, such as eBay® or Craigslist; (ii) prohibits trans-shipment of products between Dealers (or unauthorized retailers) or to locations outside of the 48 contiguous United States; and (iii) prohibits Dealer gas conversion of stock, floor or inventory units. Consumer inquiries regarding connection to bulk propane should be directed to the attention of Weber's Customer Service 1-800-446-1071. Any breach of these conditions of sale or the Weber Terms & Conditions may result in the termination of buying privileges and other remedies, for which Weber reserves all rights. See Weber's published policies relating to sale of Weber products on auction sites, trans-shipment and gas conversion for additional details.

Terms: The Terms and Conditions on Dealer's Credit Application apply to all of Dealer's purchases for Weber.

Note: Dealer is responsible for any transportation risks including the filing, if necessary, of any claims for loss or damage.

Minimum order value is \$500.00. Minimum order quantity is one master carton.

Although Weber may suggest retail prices, Dealers are free to determine the prices at which they will sell Weber products.

Note: **WEBER** gas grills sold to dealers in the United States have been tested and certified for use within the United States only; these grills have not been tested and certified for outside the United States. **WEBER** gas grills may not be exported to retailers and/or individuals living outside the United States. Gas mixtures, gas pressures, regulators, fittings and gas cylinders are different from country to country. Gas grills certified to U.S. standards may not be legal to operate outside of the United States. Use or shipment outside of the U.S. will void the limited-warranty covering any grill. If you become aware that a consumer is buying a **WEBER** gas grill with the intention of shipping it out of the United States, you should refuse the sale. Please direct any inquiries from consumers intending to use or ship a **WEBER** gas grill outside of the U.S., to Weber Customer Service 1-800-446-1071.

WARRANTY 01

GAS GRIDDLES

WEBER TABLETOP GRIDDLE 02
 WEBER SLATE 04
 WEBER GRIDDLE 06

PELLET GRILLS

SEARWOOD 07

ELECTRIC GRILLS

LUMIN 08
 Q 10

GAS GRILLS

WEBER TRAVELER 11
 Q 12
 SPIRIT 16
 GENESIS 21

PORTABLE GRILLS

SMOKEY JOE 27
 GO-ANYWHERE 28

CHARCOAL GRILLS

JUMBO JOE PREMIUM 29
 ORIGINAL KETTLE 30
 MASTER-TOUCH 31
 PERFORMER 33
 SUMMIT KAMADO 35
 SMOKERS 36
 RANCH KETTLE 36

ACCESSORIES

SMART GRILLING 37
 THERMOMETERS 38
 GRILLING TOOLS 39
 GRIDDLE TOOLS 41
 WEBER WORKS 46
 WEBER CRAFTED 48
 GBS 51
 COOKING 52
 PELLET ACCESSORIES 58
 FUEL ACCESSORIES 60
 PREP AND SERVE 62
 CARE 67
 MERCHANDISE 83

WEBER REPRESENTATIVES 86

HOW WE MEASURE 87

INDEX 88



WARRANTY



2024 GENESIS GAS GRILLS

- 12 years** Cookbox: no rust-through/burn-through (2 years on paint excluding fading or discoloration)
- 12 years** Lid assembly: no rust-through/burn-through (2 years on paint excluding fading or discoloration)
- 10 years** Stainless steel burner tubes: no rust-through/burn-through
- 10 years** Stainless steel cooking grates: no rust-through/burn-through
- 10 years** Stainless steel Flavorizer® bars: no rust-through/burn-through
- 10 years** Porcelain-enameled cast-iron cooking grates: no rust-through/burn-through
- 3 years** Electrical components (Weber Connect controller)
- 5 years** All remaining parts



SPIRIT GAS GRILL

- 10 years** Cookbox: no rust-through/burn-through (2 years on paint excluding fading or discoloration)
- 10 years** Lid assembly: no rust-through/burn-through (2 years on paint excluding fading or discoloration)
- 10 years** Stainless steel burner tubes: no rust-through/burn-through
- 5 years** Stainless steel cooking grates: no rust-through/burn-through
- 5 years** Stainless steel Flavorizer® bars: no rust-through/burn-through
- 5 years** Porcelain-enameled cast-iron cooking grates: no rust-through/burn-through
- 3 years** Electrical components (Weber Connect® controller)
- 2 years** All remaining parts

GO-ANYWHERE GAS GRILL

- 10 years** Cookbox: no rust-through/burn-through
- 10 years** Lid assembly: no rust-through/burn-through
- 5 years** Plastic components (excludes fading or discoloration)
- 2 years** All remaining parts

SUMMIT KAMADO

- 10 years** Bowl, lid, and center ring: no rust-through/burn-through
- 5 years** Stainless steel cooking grates: no rust-through/burn-through
- 5 years** One-Touch™ cleaning system: no rust-through/burn-through
- 5 years** Plastic components (excludes fading or discoloration)
- 2 years** All remaining parts

CHARCOAL GRILLS AND SMOKERS

- 10 years** Bowl, lid, and center ring: no rust-through/burn-through
- 5 years** One-Touch™ cleaning system: no rust-through/burn-through
- 5 years** Plastic components (excludes fading or discoloration)
- 2 years** All remaining parts



SEARWOOD WOOD FIRED PELLET GRILL

- 5 years** Cook box and all components not covered below
- 3 years** Electrical components (Weber Connect® controller, auger motor, fan, probes)
- 3 years** Cooking grates, burn pot, heat diffuser, heat deflector, controller bezel

WEBER TRAVELER AND WEBER TRAVELER COMPACT GAS GRILL

- 5 years** Cookbox: no rust-through/burn-through
- 5 years** Lid assembly: no rust-through/burn-through
- 3 years** Stainless steel burner tube: no rust-through/burn-through
- 3 years** Porcelain-enameled cast-iron cooking grates: no rust-through/burn-through
- 2 years** All remaining parts

WEBER LUMIN, LUMIN COMPACT ELECTRIC GRILLS AND WEBER Q SERIES: 1000, 2000, & 3000

- 5 years** Cookbox: no rust-through/burn-through (2 years on paint excluding fading or discoloration)
- 5 years** Lid assembly: no rust-through/burn-through (2 years on paint excluding fading or discoloration)
- 5 years** Stainless steel burner tubes: no rust-through/burn-through
- 5 years** Porcelain-enameled cast-iron cooking grates: no rust-through/burn-through
- 5 years** Plastic components (excluding fading or discoloration)
- 2 years** Heating element: No rust-through/burn-through
- 2 years** All remaining parts

WEBER GRIDDLE GAS GRILL

- 5 years** Cookbox: no rust-through/burn-through (2 years on paint excluding fading or discoloration)
- 5 years** Hard cover assembly: no rust-through/burn-through (2 years on paint excluding fading or discoloration)
- 5 years** Stainless steel burner tubes: no rust-through/burn-through
- 5 years** Carbon Steel Cooktop: (excluding rust)
- 5 years** All remaining parts: (excluding normal wear and tear)

GAS GRIDDLES

MAP

MSRP

WEBER SLATE 17" RUST-RESISTANT PORTABLE GRIDDLE

1500531

\$279.00

\$329.00

WEBER SLATE 17" PORTABLE GRIDDLE RR

BLACK

LP

MASTER CARTON: 1

H: 13 W: 21.4 D: 28.4 Wt: 54.7 Cu.Ft.: 4.6

DIMENSIONS - LID CLOSED

H: 9.9 W: 28.1 D: 22.7

DIMENSIONS - LID OPEN

H: 28.5 W: 28.1 D: 23.9



NEW



Details coming
soon

WEBER SLATE 22" RUST-RESISTANT PORTABLE GRIDDLE

1500532

\$329.00

\$429.00

WEBER SLATE 22" PORTABLE GRIDDLE RR

BLACK

LP

MASTER CARTON: 1

H: 12.9 W: 21.85 D: 33.5 Wt: 69.5 Cu.Ft.: 5.5

DIMENSIONS - LID CLOSED

H: 9.9 W: 37 D: 22.7

DIMENSIONS - LID OPEN

H: 28.5 W: 37 D: 25.1



NEW



Details coming
soon

MAP

MSRP

SLATE 28" RUST-RESISTANT GRIDDLE

1501345

\$549.00

\$649.00

SLATE 28" RUST-RESISTANT GRIDDLE

BLACK

LP

MASTER CARTON: 1

H: 20.5 W: 35.04 D: 20.5 Wt: 99 Cu.Ft.: 8.5

DIMENSIONS - LID CLOSED

H: 38.8 W: 63.4 D: 25.5

DIMENSIONS - LID OPEN

H: 50 W: 63.4 D: 31.5



NEW

Image coming soon

Details coming soon

SLATE 30" RUST-RESISTANT GRIDDLE

1500014

\$649.00

\$799.00

SLATE 30" RUST-RESISTANT GRIDDLE

BLACK

LP

MASTER CARTON: 1

H: 26.18 W: 25.4 D: 38.39 Wt: 179.75 Cu.Ft.: 14.8

DIMENSIONS - LID CLOSED

H: 39.5 W: 70.8 D: 23.5

DIMENSIONS - LID OPEN

H: 50.2 W: 70.8 D: 26.4



- Rust-resistant carbon-steel cooktop is ready, not rusty use after use
- Pre-seasoned and ready to cook on right out of the box
- Even, edge-to-edge heat for consistent cooking across the griddle
- Precision control knobs adjust heat smoothly and gradually
- **Weber Works** Prep, Cook, and Store System keeps griddle gear near
- Reaches over 500°F for high-heat searing and crispy edges
- Extra-large grease tray on front of griddle for quick and easy clean up
- Large cooking surface with three burners
- Mid-shelf provides a convenient space for tools, serving trays

GAS GRIDDLES

MAP

MSRP

SLATE 30" RUST-RESISTANT GRIDDLE WITH EXTENDABLE SIDE TABLE

1500013

\$799.00

\$949.00

SLATE 30" RUST-RESISTANT GRIDDLE WITH EXTENDABLE SIDE TABLE

BLACK

LP

MASTER CARTON: 1

H: 26.18 W: 25.4 D: 38.39 Wt: 201.52 Cu.Ft.: 14.8

DIMENSIONS - LID CLOSED

H: 39.5 W: 70.8 D: 23.5

DIMENSIONS - LID OPEN

H: 50.2 W: 70.8 D: 26.4



- Rust-resistant carbon-steel cooktop is ready, not rusty use after use
- Pre-seasoned and ready to cook on right out of the box
- Even, edge-to-edge heat for consistent cooking across the griddle
- Precision control knobs adjust heat smoothly and gradually
- **Weber Works** Prep, Cook, and Store system keeps griddle gear near
- Includes two **Weber Works** outdoor storage bins to keep tools handy
- Reaches over 500°F for high-heat searing and crispy edges
- Digital temperature display shows surface temperature
- Extra-large grease tray on front of griddle for quick and easy clean up
- Large cooking surface with three burners
- Mid-shelf provides a convenient space for tools, serving trays
- Extendable side table (right) provides extra workspace
- Fold-down side table (left) frees up space around the griddle

SLATE 30" RUST-RESISTANT GRIDDLE WITH EXTENDABLE SIDE TABLE

1500420

\$829.00

\$979.00

SLATE 30" RUST-RESISTANT GRIDDLE WITH EXTENDABLE SIDE TABLE

BLACK

NG

MASTER CARTON: 1

H: 26.18 W: 25.4 D: 38.39 Wt: 208.56 Cu.Ft.: 14.8

DIMENSIONS - LID CLOSED

H: 39.5 W: 70.8 D: 23.5

DIMENSIONS - LID OPEN

H: 50.2 W: 70.8 D: 26.4



- Rust-resistant carbon-steel cooktop is ready, not rusty use after use
- Pre-seasoned and ready to cook on right out of the box
- Even, edge-to-edge heat for consistent cooking across the griddle
- Precision control knobs adjust heat smoothly and gradually
- **Weber Works** Prep, Cook, and Store system keeps griddle gear near
- Includes two **Weber Works** outdoor storage bins to keep tools handy
- Reaches over 500°F for high-heat searing and crispy edges
- Digital temperature display shows surface temperature
- Extra-large grease tray on front of griddle for quick and easy clean up
- Large cooking surface with three burners
- Mid-shelf provides a convenient space for tools, serving trays
- Extendable side table (right) provides extra workspace
- Fold-down side table (left) frees up space around the griddle

MAP

MSRP

SLATE 36" RUST-RESISTANT GRIDDLE

1500216

\$999.00

\$1,149.00

SLATE 36" RUST-RESISTANT GRIDDLE

BLACK

LP

MASTER CARTON: 1

H: 26.18 W: 28.50 D: 43.31 Wt: 261.8 Cu.Ft.: 18.7

DIMENSIONS - LID CLOSED

H: 39.5 W: 77 D: 27

DIMENSIONS - LID OPEN

H: 50.2 W: 77 D: 34.3



- Rust-resistant carbon-steel cooktop is ready, not rusty use after use
- Pre-seasoned and ready to cook on right out of the box
- Even, edge-to-edge heat for consistent cooking across the griddle
- Precision control knob adjusts heat smoothly and gradually
- **Weber Works** Prep, Cook, and Store System keeps griddle gear near
- Reaches over 500°F for high-heat searing and crispy edges
- Digital temperature display shows griddle surface temperature
- Extra-large grease tray on front of griddle for quick and easy clean up
- Large cooking surface with four burners
- Mid-shelf provides a convenient space for tools, serving trays
- Extendable side table (right) provides extra workspace.
- Closed cabinet storage provides a convenient space to store tools
- Fold-down side table (left) frees up space around the griddle

SLATE 36" RUST-RESISTANT GRIDDLE

1501350

\$1029.00

\$1,229.00

SLATE 36" RUST-RESISTANT GRIDDLE

BLACK

NG

MASTER CARTON: 1

H: 26.18 W: 28.50 D: 43.31 Wt: 261.8 Cu.Ft.: 18.7

DIMENSIONS - LID CLOSED

H: 39.5 W: 77 D: 27

DIMENSIONS - LID OPEN

H: 50.2 W: 77 D: 34.3



- Rust-resistant carbon-steel cooktop is ready, not rusty use after use
- Pre-seasoned and ready to cook on right out of the box
- Even, edge-to-edge heat for consistent cooking across the griddle
- Precision control knob adjusts heat smoothly and gradually
- **Weber Works** Prep, Cook, and Store System keeps griddle gear near
- Reaches over 500°F for high-heat searing and crispy edges
- Digital temperature display shows griddle surface temperature
- Extra-large grease tray on front of griddle for quick and easy clean up
- Large cooking surface with four burners
- Mid-shelf provides a convenient space for tools, serving trays
- Extendable side table (right) provides extra workspace.
- Closed cabinet storage provides a convenient space to store tools
- Fold-down side table (left) frees up space around the griddle

GAS GRIDDLES

MAP

MSRP

WEBER RUST-RESISTANT 28" GRIDDLE G28

1501005

\$499.00

\$599.00

WEBER RUST-RESISTANT 28" GRIDDLE

BLACK

LP

MASTER CARTON: 1

H: 33.3 W: 23 D: 17.6 Wt: 110.2 Cu.Ft.: 7.8

DIMENSIONS - LID CLOSED

H: 36.9 W: 53 D: 24.1

DIMENSIONS - LID OPEN

H: 45.1 W: 53 D: 24.1



NEW



Details coming
soon

WEBER RUST-RESISTANT 36" GRIDDLE G36

1501006

\$649.00

\$799.00

WEBER RUST-RESISTANT 36" GRIDDLE G36

BLACK

LP

MASTER CARTON: 1

H: 40.6 W: 27.4 D: 17.3 Wt: 154.3 Cu.Ft.: 11.1

DIMENSIONS - LID CLOSED

H: 37.3 W: 61 D: 25.8

DIMENSIONS - LID OPEN

H: 47.9 W: 61 D: 28.4



NEW



Details coming
soon

MAP

MSRP

SEARWOOD 600 PELLETT GRILL

1500120

\$899.00

\$1,049.00

SEARWOOD 600 PELLETT GRILL

BLACK

MASTER CARTON: 1

H: 31.42 W: 40.2 D: 23.75 Wt: 160 Cu.Ft.: 17.3

DIMENSIONS - LID CLOSED

H: 45.75 W: 38.5 D: 23

DIMENSIONS - LID OPEN

H: 59.5 W: 38.5 D: 28.5



- Full temperature range from 180° to 600°F for smoking and searing
- 648 sq. inches of cooking space
- **DirectFlame™** cooking creates searing, crisping, and browning
- Full grate sear zone puts more food on the flame
- **Rapid React™** PID heats up fast and regains temp when lid opens
- **SMOKEBOOST** setting intensifies smoky flavor
- Compatible with **Rust-Resistant 24" Full Size Griddle Insert** (sold separately)
- Compatible with **Heavy-Duty Rotisserie** (sold separately)
- **WEBER CRAFTED** grates and grillware compatible (sold separately)
- Pull and clean grease and ash management system for easy clean up, no vacuum required
- Large cooking capacity with two levels
- Side hopper provides convenient access to load pellets
- Hopper designed with smooth, continuous pellet flow for worry-free remote cooking
- **WEBER CONNECT digital LCD controller** with easy-to-navigate settings
- **WEBER CONNECT** app lets you monitor and control grill remotely
- Porcelain-enameled lid is highly durable and won't rust or peel
- Ergonomic design with large wheels and built-in handle
- **EZ Access Maintenance Panel** makes it simple to troubleshoot

SEARWOOD XL 600 PELLETT GRILL

1500121

\$1,199.00

\$1,399.00

SEARWOOD XL 600 PELLETT GRILL

BLACK

MASTER CARTON: 1

H: 31.42 W: 52.02 D: 23.75 Wt: 196 Cu.Ft.: 22.5

DIMENSIONS - LID CLOSED

H: 45.75 W: 50.5 D: 23

DIMENSIONS - LID OPEN

H: 59.5 W: 50.5 D: 28.5



- Full temperature range from 180° to 600°F for smoking and searing
- 972 sq. inches of cooking space
- **DirectFlame™** cooking creates searing, crisping, and browning
- Full grate sear zone puts more food on the flame
- Fuel gauge displays pellet level (available on XL only)
- **Rapid React™** PID heats up fast and regains temp when lid opens
- **SMOKEBOOST** setting intensifies smoky flavor
- Compatible with **Rust-Resistant 24" Full Size Griddle Insert** (sold separately)
- Compatible with **Heavy-Duty Rotisserie** (sold separately)
- **WEBER CRAFTED** cooking grate and grillware (sold separately)
- Pull and clean grease and ash management system for easy clean up, no vacuum required
- Large cooking capacity with two levels
- Side hopper provides convenient access to load pellets
- Hopper designed with smooth, continuous pellet flow for worry-free remote cooking
- **WEBER CONNECT digital LCD controller** with easy-to-navigate settings
- **WEBER CONNECT** app lets you monitor and control grill remotely
- Porcelain-enameled lid is highly durable and won't rust or peel
- Ergonomic design with large wheels and built-in handle
- **EZ Access Maintenance Panel** makes it simple to troubleshoot

ELECTRIC GRILLS

MAP

MSRP

LUMIN COMPACT ELECTRIC GRILL

91010901

\$399.00

\$499.00

LUMIN COMPACT ELECTRIC GRILL

BLACK

MASTER CARTON: 1

H: 11.65 W: 16.6 D: 20.9 Wt: 35.75 Cu.Ft.: 2.3

DIMENSIONS - LID CLOSED

H: 11.0 W: 23.0 D: 16.5

DIMENSIONS - LID OPEN

H: 22.5 W: 23.0 D: 18.0



0 77924 19070 4



- Total cooking area = 180 square inches
- Reaches over 600°F (315°C)
- Sear, smoke, steam or boil
- Keep food warm for hours
- Thaw frozen food while preheating
- Available in a variety of colors: deep ocean blue, seafoam green, golden yellow, ice blue, and black
- Power = 120 V
- Porcelain-Enameled, Cast-Iron Cooking Grates
- Porcelain-Enameled lid
- Ceramic heating element
- 6 ft power cord
- Reversible Steam Pan
- Steaming/Smoking Reservoir
- Temperature Controller
- Disposable Drip Tray
- Slide-Out Catch Pan
- Plastic Scraper

91300901

\$429.00

\$529.00

LUMIN COMPACT ELECTRIC GRILL

DEEP OCEAN BLUE

MASTER CARTON: 1

H: 11.65 W: 16.6 D: 20.9 Wt: 35.75 Cu.Ft.: 2.3

DIMENSIONS - LID CLOSED

H: 11.0 W: 23.0 D: 16.5

DIMENSIONS - LID OPEN

H: 22.5 W: 23.0 D: 18.0



0 77924 19619 5

91280901

\$429.00

\$529.00

LUMIN COMPACT ELECTRIC GRILL

GOLDEN YELLOW

MASTER CARTON: 1

H: 11.65 W: 16.6 D: 20.9 Wt: 35.75 Cu.Ft.: 2.3

DIMENSIONS - LID CLOSED

H: 11.0 W: 23.0 D: 16.5

DIMENSIONS - LID OPEN

H: 22.5 W: 23.0 D: 18.0



0 77924 19627 0

91070901

\$429.00

\$529.00

LUMIN COMPACT ELECTRIC GRILL

SEAFOAM GREEN

MASTER CARTON: 1

H: 11.65 W: 16.6 D: 20.9 Wt: 35.75 Cu.Ft.: 2.3

DIMENSIONS - LID CLOSED

H: 11.0 W: 23.0 D: 16.5

DIMENSIONS - LID OPEN

H: 22.5 W: 23.0 D: 18.0



0 77924 19623 2

91400901

\$429.00

\$529.00

LUMIN COMPACT ELECTRIC GRILL

ICE BLUE

MASTER CARTON: 1

H: 11.65 W: 16.6 D: 20.9 Wt: 35.75 Cu.Ft.: 2.3

DIMENSIONS - LID CLOSED

H: 11.0 W: 23.0 D: 16.5

DIMENSIONS - LID OPEN

H: 22.5 W: 23.0 D: 18.0



0 77924 19621 8

MAP

MSRP

LUMIN ELECTRIC GRILL

92010901 \$449.00 \$549.00

LUMIN ELECTRIC GRILL BLACK

MASTER CARTON: 1

H: 13.0 W: 19.65 D: 23.55 Wt: 46.65 Cu.Ft.: 3.5

DIMENSIONS - LID CLOSED

H: 12.0 W: 26.0 D: 19.0

DIMENSIONS - LID OPEN

H: 25.5 W: 25.5 D: 21.0



0 77924 19071 1



- Total cooking area = 242 square inches
- Reaches over 600°F (315°C)
- Sear, smoke, steam or boil
- Keep food warm for hours
- Thaw frozen food while preheating
- Available in a variety of colors: deep ocean blue, seafoam green, golden yellow, ice blue, and black
- Power = 120 V
- Porcelain-Enameled, Cast-Iron Cooking Grates
- Porcelain-Enameled lid
- Ceramic heating element
- 6 ft power cord
- Reversible Steam Pan
- Steaming/Smoking Reservoir
- Temperature Controller
- Disposable Drip Tray
- Slide-Out Catch Pan
- Plastic Scraper

92300901 \$489.00 \$589.00

LUMIN ELECTRIC GRILL DEEP OCEAN BLUE

MASTER CARTON: 1

H: 13.0 W: 19.65 D: 23.55 Wt: 46.65 Cu.Ft.: 3.5

DIMENSIONS - LID CLOSED

H: 12.0 W: 26.0 D: 19.0

DIMENSIONS - LID OPEN

H: 25.5 W: 25.5 D: 21.0



0 77924 19620 1

92280901 \$489.00 \$589.00

LUMIN ELECTRIC GRILL GOLDEN YELLOW

MASTER CARTON: 1

H: 13.0 W: 19.65 D: 23.55 Wt: 46.65 Cu.Ft.: 3.5

DIMENSIONS - LID CLOSED

H: 12.0 W: 26.0 D: 19.0

DIMENSIONS - LID OPEN

H: 25.5 W: 25.5 D: 21.0



0 77924 19628 7

92070901 \$489.00 \$589.00

LUMIN ELECTRIC GRILL SEAFOAM GREEN

MASTER CARTON: 1

H: 13.0 W: 19.65 D: 23.55 Wt: 46.65 Cu.Ft.: 3.5

DIMENSIONS - LID CLOSED

H: 12.0 W: 26.0 D: 19.0

DIMENSIONS - LID OPEN

H: 25.5 W: 25.5 D: 21.0



0 77924 19624 9

92400901 \$489.00 \$589.00

LUMIN ELECTRIC GRILL ICE BLUE

MASTER CARTON: 1

H: 13.0 W: 19.65 D: 23.55 Wt: 46.65 Cu.Ft.: 3.5

DIMENSIONS - LID CLOSED

H: 12.0 W: 26.0 D: 19.0

DIMENSIONS - LID OPEN

H: 25.5 W: 25.5 D: 21.0



0 77924 19622 5

ELECTRIC GRILLS

MAP

MSRP

WEBER Q 1400 ELECTRIC GRILL

52020001

\$329.00

\$429.00

WEBER Q 1400 ELECTRIC GRILL

DARK GRAY

MASTER CARTON: 1

H: 16.8 W: 28.3 D: 16.3 Wt: 28.0 Cu.Ft.: 4.4

DIMENSIONS - LID CLOSED

H: 14.5 W: 27.0 D: 16.5

DIMENSIONS - LID OPEN

H: 23.5 W: 27.0 D: 20.5



- Total cooking area = 189 square inches
- Porcelain-enameled, cast-iron cooking grates
- 1,560 watts - 120 volts
- Infinite heat control settings
- Aluminum heat retention liners
- Cast aluminum lid and body
- Glass-reinforced nylon frame
- Removable catch pan
- 6-foot grounded cord

MAP

MSRP

WEBER TRAVELER GAS GRILL

9010001	\$399.00	\$499.00
WEBER TRAVELER GAS GRILL	BLACK	LP
MASTER CARTON: 1		
H: 14.7	W: 22.1	D: 42.7 Wt: 63.0 Cu.Ft.: 7.9
DIMENSIONS - LID CLOSED		
H: 37.2	W: 43.6	D: 23.0
DIMENSIONS - LID OPEN		
H: 50.0	W: 43.6	D: 26.0



9013001	\$449.00	\$549.00
WEBER TRAVELER GAS GRILL	STEALTH	LP
MASTER CARTON: 1		
H: 14.7	W: 22.1	D: 42.7 Wt: 63.0 Cu.Ft.: 7.9
DIMENSIONS - LID CLOSED		
H: 37.2	W: 43.6	D: 23.0
DIMENSIONS - LID OPEN		
H: 50.0	W: 43.6	D: 26.0



- Total cooking area = 320 square inches
- One stainless steel burner
- 13,000 BTU-per-hour input main burner
- Porcelain-enameled, cast-iron cooking grates
- Push button ignition
- Infinite control burner valve
- Porcelain enameled steel lid and cookbox
- Integrated steel folding cart
- One hand set-up and fold with automatic lid lock
- Rigid, large side table
- Built-in lid thermometer
- Two rubberized outer wheels
- Removable catch pan
- Uses disposable 16 oz. LP cylinder (sold separately)
- Available in a variety of colors: deep ocean blue, red, stealth, and black

9020001	\$449.00	\$549.00
WEBER TRAVELER GAS GRILL	DEEP OCEAN BLUE	LP
MASTER CARTON: 1		
H: 14.7	W: 22.1	D: 42.7 Wt: 63.0 Cu.Ft.: 7.9
DIMENSIONS - LID CLOSED		
H: 37.2	W: 43.6	D: 23.0
DIMENSIONS - LID OPEN		
H: 50.0	W: 43.6	D: 26.0



9030001	\$449.00	\$549.00
WEBER TRAVELER GAS GRILL	RED	LP
MASTER CARTON: 1		
H: 14.7	W: 22.1	D: 42.7 Wt: 63.0 Cu.Ft.: 7.9
DIMENSIONS - LID CLOSED		
H: 37.2	W: 43.6	D: 23.0
DIMENSIONS - LID OPEN		
H: 50.0	W: 43.6	D: 26.0



GAS GRILLS

MAP

MSRP

WEBER TRAVELER COMPACT PORTABLE GRILL

1500460	\$299.00	\$349.00
WEBER TRAVELER COMPACT	BLACK	LP
MASTER CARTON: 1		
H: 16	W: 33	D: 23.5
Wt: 49	Cu.Ft.: 7.2	
DIMENSIONS - LID CLOSED		
H: 34.75	W: 34	D: 21.5
DIMENSIONS - LID OPEN		
H: 48	W: 34	D: 25.5



- 32" wide, fits in the trunk of most mid-size cars
- Raises and collapses with one hand
- Lid lock automatically latches once the grill is folded down.
- Durable wheels make it easy to move across any terrain
- Feed up to 4 people, fits 12 burgers or 15 sausages
- Wide temperature range to sear at high heat or roast at lower temperatures
- Porcelain-enameled, cast-iron cooking grates retain heat for searing
- Ignites smoothly with a simple twist of a knob
- Front access grease removal for quick and easy clean up
- Porcelain-enameled lid retains heat, won't rust or peel
- Side table provides extra space for prepping and serving
- Available in stealth color, all-black design
- Three integrated tool hooks keep spatulas and tongs handy

WEBER Q 1000 GAS GRILL

50060001	\$229.00	\$279.00
WEBER Q 1000 GAS GRILL	TITANIUM	LP
MASTER CARTON: 1		
H: 16.8	W: 28.3	D: 16.3
Wt: 28.0	Cu.Ft.: 4.4	
DIMENSIONS - LID CLOSED		
H: 14.5	W: 27.0	D: 16.5
DIMENSIONS - LID OPEN		
H: 23.5	W: 27.0	D: 20.5



- Total cooking area = 189 square inches
- Stainless steel burner
- 8,500 BTU-per-hour input main burner
- Porcelain-enameled, cast-iron cooking grates
- Push button ignition
- Infinite control burner valve
- Cast aluminum lid and body
- Glass-reinforced nylon frame
- Removable catch pan
- Uses disposable 14.1 or 16.4 oz. LP cylinder (sold separately)

MAP

MSRP

WEBER Q 1200 GAS GRILL

51060001

\$259.00

\$309.00

WEBER Q 1200 GAS GRILL

TITANIUM

LP

MASTER CARTON: 1

H: 17.0 W: 28.0 D: 16.0 Wt: 30.0 Cu.Ft.: 4.6

DIMENSIONS - LID CLOSED AND TABLES OUT

H: 15.5 W: 40.9 D: 16.5

DIMENSIONS - LID OPEN AND TABLES OUT

H: 24.6 W: 40.9 D: 20.5



- Total cooking area = 189 square inches
- Stainless steel burner
- 8,500 BTU-per-hour input main burner
- Porcelain-enameled, cast-iron cooking grates
- Electronic ignition
- Infinite control burner valve
- Cast aluminum lid and body
- Glass-reinforced nylon frame
- Two folding work tables
- Removable catch pan
- Built-in lid thermometer
- Uses disposable 14.1 or 16.4 oz. LP cylinder (sold separately)

51010001

BLACK LP



51080001

BLUE LP



51190001

ORANGE LP



51040001

RED LP



51070001

GREEN LP



GAS GRILLS

MAP

MSRP

Q 2800N+ Gas Grill

1500375

\$399.00

\$499.00

WEBER Q 2800N+ GAS GRILL

MIDNIGHT BLACK LP

MASTER CARTON: 1

H: 17.52 W: 18.7 D: 31.3 Wt: 51.33 Cu.Ft.: 5.9

DIMENSIONS - LID CLOSED AND TABLES OUT

H: 16.7 W: 30 D: 19.7

DIMENSIONS - LID OPEN AND TABLES OUT

H: 28.87 W: 30 D: 26.5



0 77924 99597 2



- Wide temperature range 250° - 700°F provides more ways to grill
- Plus burner (+) lets you reach and maintain extra high or low temps
- Large grilling surface lets you cook multiple foods at once
- High-dome lid accommodates larger foods like whole chickens
- Griddle insert (sold separately) expands cooking techniques
- Front-facing grease tray enables quick and easy grease disposal
- Side tables detach for easy storage
- Porcelain-enameled, cast-iron grates retain heat for searing
- Built-in mounting for **WEBER CONNECT** WIFI hub (sold separately)
- Lid thermometer clearly and accurately displays temperature
- Venting improves even heating and wind resistance

1500377

FLAME RED LP



0 77924 99599 6

1500378

CHARCOAL GREY LP



0 77924 99600 9

1500376

SMOKE GREY LP



0 77924 99598 9

1500379

SKY BLUE LP



0 77924 99601 6

MAP

MSRP

Q 2800N+ Gas Grill

1500390

\$499.00

\$599.00

WEBER Q 2800N+ GAS GRILL WITH STAND MIDNIGHT BLACK LP

MASTER CARTON: 1

H: 26.58 W: 31.3 D: 22.32 Wt: 92.4 Cu.Ft.: 10.7

DIMENSIONS - LID CLOSED AND TABLES OUT

H: 42.8 W: 30 D: 19.7

DIMENSIONS - LID OPEN AND TABLES OUT

H: 55.01 W: 30 D: 26.5



0 77924 99605 4

1500391

FLAME RED LP



0 77924 99606 1

1500393

CHARCOAL GREY LP



0 77924 99608 5

1500392

SMOKE GREY LP



0 77924 99607 8

1500394

SKY BLUE LP



0 77924 99609 2



- Wide temperature range 250° - 700°F provides more ways to grill
- Plus burner (+) lets you reach and maintain extra high or low temps
- Large grilling surface lets you cook multiple foods at once
- High-dome lid accommodates larger foods like whole chickens
- Griddle insert (sold separately) expands cooking techniques
- Front-facing grease tray enables quick and easy grease disposal
- Side tables detach for easy storage
- Porcelain-enameled, cast-iron grates retain heat for searing
- Built-in mounting for **WEBER CONNECT** WIFI hub (sold separately)
- Lid thermometer clearly and accurately displays temperature
- Venting improves even heating and wind resistance

GAS GRILLS

MAP

MSRP

SPIRIT E-210 GAS GRILL

1501000

\$399.00

\$499.00

SPIRIT E-210 GAS GRILL

BLACK

LP

MASTER CARTON: 1

H: 21.1 W: 26 D: 32.7 Wt: 103 Cu.Ft.: 10.4

DIMENSIONS - LID CLOSED

H: 46.2 W: 48.3 D: 26.6

DIMENSIONS - LID OPEN

H: 60.5 W: 48.3 D: 31



0 77924 89359 9

NEW



- 10-year limited warranty
- **Weber Works** side rails for snap-on accessories sold separately
- Precise, consistent heat cooks food evenly across the grill
- **SNAP-JET** Ignition for one hand lighting of individual burners
- Porcelain-enameled, cast-iron cooking grates retain even heat
- Cast-aluminum cook box is built to last
- Stainless steel **FLAVORIZER** Bars boost grilled flavor
- Grease management system with removable grease tray
- 4 Tool hooks keep spatulas and tongs handy
- Cabinet with door keeps propane tank out of view
- Warming rack keeps food warm or toasts buns above main grates
- Durable all-weather wheels make moving the grill easy
- Hammertone metal side tables keep items within reach
- Rotisserie accessory (sold separately) browns food evenly

SPIRIT E-310 GAS GRILL

1500788

\$449.00

\$549.00

SPIRIT E-310 GAS GRILL

BLACK

LP

MASTER CARTON: 1

H: 21.1 W: 26 D: 32.7 Wt: 103 Cu.Ft.: 10.4

DIMENSIONS - LID CLOSED

H: 46.2 W: 48.3 D: 26.6

DIMENSIONS - LID OPEN

H: 60.5 W: 48.3 D: 31



0 77924 01604 2

NEW



- 10-year limited warranty
- **Weber Works** side rails for snap-on accessories sold separately
- Precise, consistent heat cooks food evenly across the grill
- **SNAP-JET** Ignition for one hand lighting of individual burners
- Porcelain-enameled, cast-iron cooking grates retain even heat
- Cast-aluminum cook box is built to last
- Stainless steel **FLAVORIZER** Bars boost grilled flavor
- Grease management system with removable grease tray
- 4 Tool hooks keep spatulas and tongs handy
- Cabinet with door keeps propane tank out of view
- Warming rack keeps food warm or toasts buns above main grates
- Durable all-weather wheels make moving the grill easy
- Hammertone metal side tables keep items within reach
- Rotisserie accessory (sold separately) browns food evenly

MAP

MSRP

SPIRIT E-325 GAS GRILL

NEW

1500789	\$499.00	\$599.00
SPIRIT E-325 GAS GRILL	BLACK	LP
MASTER CARTON: 1		
H: 21.1	W: 26	D: 32.7 Wt: 103 Cu.Ft.: 10.4
DIMENSIONS - LID CLOSED		
H: 46.2	W: 48.3	D: 26.6
DIMENSIONS - LID OPEN		
H: 60.5	W: 48.3	D: 31



- 10-year limited warranty
- 2 **Boost Burners** unleash 40% more power in the Sear Zone
- **Weber Works** side rails for snap-on accessories sold separately
- Precise, consistent heat cooks food evenly across the grill
- **SNAP-JET** Ignition for one hand lighting of individual burners
- Porcelain-enameled, cast-iron cooking grates retain even heat
- Cast-aluminum cook box is built to last
- Stainless steel **FLAVORIZER** Bars boost grilled flavor
- Grease management system with removable grease tray
- 4 Tool hooks keep spatulas and tongs handy
- Cabinet with door keeps propane tank out of view
- Warming rack keeps food warm or toasts buns above main grates
- Durable all-weather wheels make moving the grill easy
- Hammertone metal side tables keep items within reach
- Rotisserie accessory (sold separately) browns food evenly

1500844	\$499.00	\$599.00
SPIRIT E-325 GAS GRILL	BLACK	NG
MASTER CARTON: 1		
H: 21.1	W: 26	D: 32.7 Wt: 103 Cu.Ft.: 10.4
DIMENSIONS - LID CLOSED		
H: 46.2	W: 48.3	D: 26.6
DIMENSIONS - LID OPEN		
H: 60.5	W: 48.3	D: 31



SPIRIT E-425 GAS GRILL

NEW

1500780	\$599.00	\$699.00
SPIRIT E-425 GAS GRILL	BLACK	LP
MASTER CARTON: 1		
H: 21	W: 29.3	D: 32.7 Wt: 126 Cu.Ft.: 11.6
DIMENSIONS - LID CLOSED		
H: 46.2	W: 51.8	D: 26.6
DIMENSIONS - LID OPEN		
H: 60.5	W: 51.8	D: 31



- 10-year limited warranty
- 2 **Boost Burners** unleash 40% more power in the Sear Zone
- **Weber Works** side rails for snap-on accessories sold separately
- Precise, consistent heat cooks food evenly across the grill
- **SNAP-JET** Ignition for one hand lighting of individual burners
- Porcelain-enameled, cast-iron cooking grates retain even heat
- Cast-aluminum cook box is built to last
- Stainless steel **FLAVORIZER** Bars boost grilled flavor
- **WEBER CRAFTED** grillware compatible (sold separately)
- Grease management system with removable grease tray
- 4 Tool hooks keep spatulas and tongs handy
- Cabinet with door keeps propane tank out of view
- Warming rack keeps food warm or toasts buns above main grates
- Durable all-weather wheels make moving the grill easy
- Hammertone metal side tables keep items within reach
- Rust-Resistant Griddle Insert (sold separately) fits into grill
- Rotisserie accessory (sold separately) browns food evenly

1500781	\$599.00	\$699.00
SPIRIT E-425 GAS GRILL	BLACK	NG
MASTER CARTON: 1		
H: 21	W: 29.3	D: 32.7 Wt: 126 Cu.Ft.: 11.6
DIMENSIONS - LID CLOSED		
H: 46.2	W: 51.8	D: 26.6
DIMENSIONS - LID OPEN		
H: 60.5	W: 51.8	D: 31



GAS GRILLS

MAP

MSRP

SPIRIT EP-325 GAS GRILL

1500792

\$599.00

\$699.00

SPIRIT EP-325 GAS GRILL

BLACK

LP

MASTER CARTON: 1

H: 21.1 W: 26 D: 32.7 Wt: 103 Cu.Ft.: 10.4

DIMENSIONS - LID CLOSED

H: 46.2 W: 48.3 D: 25.5

DIMENSIONS - LID OPEN

H: 60.5 W: 48.3 D: 31



0 77924 01613 4

NEW

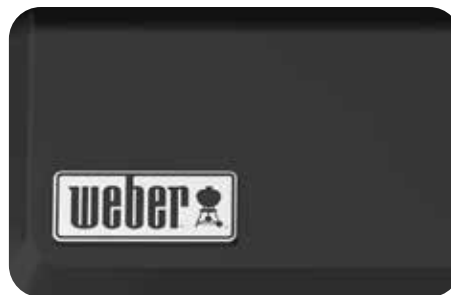

- 10-year limited warranty
- **2 Boost Burners** unleash 40% more power in the Sear Zone
- Digital thermometer lets you see precise temp day and night
- **Weber Works** side table fits drop-in inserts (sold separately)
- **Weber Works** side rails for snap-on accessories sold separately
- Stainless steel control panel looks sharp and cleans easily
- Stainless steel side tables are stylish and durable
- Heavy-duty locking swivel casters make moving easy
- Precise, consistent heat cooks food evenly across the grill
- **SNAP-JET** Ignition for one hand lighting of individual burners
- Porcelain-enameled, cast-iron cooking grates retain even heat
- Cast-aluminum cook box is built to last
- Stainless steel **FLAVORIZER** Bars boost grilled flavor
- Grease management system with removable grease tray
- 4 Tool hooks keep spatulas and tongs handy
- Cabinet with door keeps propane tank out of view
- Warming rack keeps food warm or toasts buns above main grates
- Rotisserie accessory (sold separately) browns food evenly

1500845

\$599.00

\$699.00

SPIRIT EP-325 GAS GRILL

BLACK

NG

MASTER CARTON: 1

H: 21.1 W: 26 D: 32.7 Wt: 103 Cu.Ft.: 10.4

DIMENSIONS - LID CLOSED

H: 46.2 W: 48.3 D: 25.5

DIMENSIONS - LID OPEN

H: 60.5 W: 48.3 D: 31



0 77924 01613 4

SPIRIT S-425 GAS GRILL

1500790

\$699.00

\$849.00

SPIRIT S-425 GAS GRILL

STAINLESS STEEL

LP

MASTER CARTON: 1

H: 21 W: 29.3 D: 32.7 Wt: 126 Cu.Ft.: 11.6

DIMENSIONS - LID CLOSED

H: 46.2 W: 51.8 D: 26.6

DIMENSIONS - LID OPEN

H: 60.5 W: 51.8 D: 31



0 77924 01608 0

NEW



- 10-year limited warranty
- **2 Boost Burners** unleash 40% more power in the Sear Zone
- **Weber Works** side rails for snap-on accessories sold separately
- Stainless steel control panel looks sharp and cleans easily
- Stainless steel side tables are stylish and durable
- Precise, consistent heat cooks food evenly across the grill
- **SNAP-JET** Ignition for one hand lighting of individual burners
- Porcelain-enameled, cast-iron cooking grates retain even heat
- Cast-aluminum cook box is built to last
- Stainless steel **FLAVORIZER** Bars boost grilled flavor
- **WEBER CRAFTED** grillware compatible (sold separately)
- Grease management system with removable grease tray
- 4 Tool hooks keep spatulas and tongs handy
- Cabinet with door keeps propane tank out of view
- Warming rack keeps food warm or toasts buns above main grates
- Durable all-weather wheels make moving the grill easy
- Rust-Resistant Griddle Insert (sold separately) fits into grill
- Rotisserie accessory (sold separately) browns food evenly

1500791

\$699.00

\$849.00

SPIRIT S-425 GAS GRILL

STAINLESS STEEL

NG

MASTER CARTON: 1

H: 21 W: 29.3 D: 32.7 Wt: 126 Cu.Ft.: 11.6

DIMENSIONS - LID CLOSED

H: 46.2 W: 51.8 D: 26.6

DIMENSIONS - LID OPEN

H: 60.5 W: 51.8 D: 31



0 77924 01612 7

MAP

MSRP

SPIRIT E-435 GAS GRILL

NEW

1500782	\$699.00	\$849.00
SPIRIT E-435 GAS GRILL	BLACK	LP
MASTER CARTON: 1		
H: 21	W: 29.3	D: 32.7 Wt: 126 Cu.Ft.: 11.6
DIMENSIONS - LID CLOSED		
H: 46.2	W: 51.8	D: 26.6
DIMENSIONS - LID OPEN		
H: 60.5	W: 51.8	D: 31



- 10-year limited warranty
- 2 **Boost Burners** unleash 40% more power in the Sear Zone
- **Weber Works** side rails for snap-on accessories sold separately
- Side burner provides extra cooking space for sauces and sides
- Precise, consistent heat cooks food evenly across the grill
- **SNAP-JET** Ignition for one hand lighting of individual burners
- Porcelain-enameled, cast-iron cooking grates retain even heat
- Cast-aluminum cook box is built to last
- Stainless steel **FLAVORIZER** Bars boost grilled flavor
- **WEBER CRAFTED** grillware compatible (sold separately)
- Grease management system with removable grease tray
- 4 Tool hooks keep spatulas and tongs handy
- Cabinet with door keeps propane tank out of view
- Warming rack keeps food warm or toasts buns above main grates
- Durable all-weather wheels make moving the grill easy
- Hammertone metal side tables keep items within reach
- Rust-Resistant Griddle Insert (sold separately) fits into grill
- Rotisserie accessory (sold separately) browns food evenly

1500783	\$699.00	\$849.00
SPIRIT E-435 GAS GRILL	BLACK	NG
MASTER CARTON: 1		
H: 21	W: 29.3	D: 32.7 Wt: 126 Cu.Ft.: 11.6
DIMENSIONS - LID CLOSED		
H: 46.2	W: 51.8	D: 26.6
DIMENSIONS - LID OPEN		
H: 60.5	W: 51.8	D: 31



SPIRIT EP-425 GAS GRILL

NEW

1500784	\$699.00	\$849.00
SPIRIT EP-425 GAS GRILL	BLACK	LP
MASTER CARTON: 1		
H: 21	W: 29.3	D: 32.7 Wt: 126 Cu.Ft.: 11.6
DIMENSIONS - LID CLOSED		
H: 46.3	W: 51.8	D: 25.5
DIMENSIONS - LID OPEN		
H: 60.5	W: 51.8	D: 31



- 10-year limited warranty
- 2 **Boost Burners** unleash 40% more power in the Sear Zone
- Digital thermometer lets you see precise temp day and night
- **Weber Works** side table fits drop-in inserts (sold separately)
- **Weber Works** side rails for snap-on accessories sold separately
- Stainless steel control panel looks sharp and cleans easily
- Stainless steel side tables are stylish and durable
- Heavy-duty locking swivel casters make moving easy
- Precise, consistent heat cooks food evenly across the grill
- **SNAP-JET** Ignition for one hand lighting of individual burners
- Porcelain-enameled, cast-iron cooking grates retain even heat
- Cast-aluminum cook box is built to last
- Stainless steel **FLAVORIZER** Bars boost grilled flavor
- **WEBER CRAFTED** grillware compatible (sold separately)
- Grease management system with removable grease tray
- 4 Tool hooks keep spatulas and tongs handy
- Cabinet with door keeps propane tank out of view
- Warming rack keeps food warm or toasts buns above main grates
- Rust-Resistant Griddle Insert (sold separately) fits into grill
- Rotisserie accessory (sold separately) browns food evenly

1500785	\$699.00	\$849.00
SPIRIT EP-425 GAS GRILL	BLACK	NG
MASTER CARTON: 1		
H: 21	W: 29.3	D: 32.7 Wt: 126 Cu.Ft.: 11.6
DIMENSIONS - LID CLOSED		
H: 46.3	W: 51.8	D: 25.5
DIMENSIONS - LID OPEN		
H: 60.5	W: 51.8	D: 31



GAS GRILLS

MAP

MSRP

SPIRIT EP-435 GAS GRILL

1500786

\$799.00

\$949.00

SPIRIT EP-435 GAS GRILL

BLACK

LP

MASTER CARTON: 1

H: 21 W: 29.3 D: 32.7 Wt: 126 Cu.Ft.: 11.6

DIMENSIONS - LID CLOSED

H: 46.3 W: 51.8 D: 25.5

DIMENSIONS - LID OPEN

H: 60.5 W: 51.8 D: 31



NEW



- 10-year limited warranty
- **2 Boost Burners** unleash 40% more power in the Sear Zone
- Digital thermometer lets you see precise temp day and night
- **Weber Works** side table fits drop-in inserts (sold separately)
- **Weber Works** side rails for snap-on accessories sold separately
- Stainless steel control panel looks sharp and cleans easily
- Stainless steel side tables are stylish and durable
- Heavy-duty locking swivel casters make moving easy
- Precise, consistent heat cooks food evenly across the grill
- **SNAP-JET** Ignition for one hand lighting of individual burners
- Porcelain-enameled, cast-iron cooking grates retain even heat
- Cast-aluminum cook box is built to last
- Stainless steel **FLAVORIZER** Bars boost grilled flavor
- **WEBER CRAFTED** grillware compatible (sold separately)
- Grease management system with removable grease tray
- 4 Tool hooks keep spatulas and tongs handy
- Cabinet with door keeps propane tank out of view
- Warming rack keeps food warm or toasts buns above main grates
- Rust-Resistant Griddle Insert (sold separately) fits into grill
- Rotisserie accessory (sold separately) browns food evenly

1500787

\$799.00

\$949.00

SPIRIT EP-435 GAS GRILL

BLACK

NG

MASTER CARTON: 1

H: 21 W: 29.3 D: 32.7 Wt: 126 Cu.Ft.: 11.6

DIMENSIONS - LID CLOSED

H: 46.3 W: 51.8 D: 25.5

DIMENSIONS - LID OPEN

H: 60.5 W: 51.8 D: 31



MAP

MSRP

GENESIS E-315 GAS GRILL

1500010	\$799.00	\$949.00
GENESIS E-315 GAS GRILL	BLACK	LP
MASTER CARTON: 1		
H: 25.98	W: 30.32	D: 36.06 Wt: 183.53 Cu.Ft.: 16.4
DIMENSIONS - LID CLOSED		
H: 48.1	W: 57.7	D: 27.0
DIMENSIONS - LID OPEN		
H: 63.0	W: 57.7	D: 30.6



- Primary Cooking Area = 513 square inches
- Secondary Cooking grate area = 127.5 square inches
- Total Cooking area = 640.5 square inches
- Three stainless steel burners
- 39,000 BTU-per-hour input main burners
- Compatible with **WEBER CRAFTED** (frame & grillware sold separate)
- Porcelain-enameled, cast-iron grates retain heat for searing
- Stainless steel **FLAVORIZER** bars
- **FLAVORIZER** Bars vaporize juices, boosting grilled flavor
- Flush electronic push button ignition system, 1 AA battery included
- Porcelain-enameled lid with thermometer
- Painted enclosed steel cabinet with painted steel doors
- Side tables keep platters, seasonings, and tools within arm's reach
- Grease Management System with pull out grease tray
- Six tool hooks
- Two front locking castors / Two back swivel casters
- Propane tank inside the cabinet
- Natural gas grill includes a 10-foot flexible hose
- **PureBlu** burners distribute even heat across the entire grate
- Warming rack keeps food warm or toasts buns
- Large cooking surface, space to grill an entire meal at once

1500011	\$799.00	\$949.00
GENESIS E-315 GAS GRILL	BLACK	NG
MASTER CARTON: 1		
H: 25.98	W: 30.32	D: 36.06 Wt: 183.53 Cu.Ft.: 16.4
DIMENSIONS - LID CLOSED		
H: 48.1	W: 57.7	D: 27.0
DIMENSIONS - LID OPEN		
H: 63.0	W: 57.7	D: 30.6



GENESIS S-315 GAS GRILL

1500568	\$899.00	\$1,049.00
GENESIS S-315 GAS GRILL	STAINLESS STEEL	LP
MASTER CARTON: 1		
H: 25.98	W: 30.32	D: 36.06 Wt: 188 Cu.Ft.: 16.4
DIMENSIONS - LID CLOSED		
H: 48.1	W: 57.7	D: 27.0
DIMENSIONS - LID OPEN		
H: 63.0	W: 57.7	D: 30.6



- Primary Cooking Area = 513 square inches
- Secondary Cooking grate area = 127.5 square inches
- Total Cooking area = 640.5 square inches
- Three stainless steel burners
- 39,000 BTU-per-hour input main burners
- Compatible with **WEBER CRAFTED** (frame & grillware sold separate)
- 7mm Stainless steel cooking grates heat quickly, are highly durable
- Stainless steel **FLAVORIZER** bars
- **FLAVORIZER** Bars vaporize juices, boosting grilled flavor
- Flush electronic push button ignition system, 1 AA battery included
- Stainless steel lid with thermometer
- Painted enclosed steel cabinet with stainless steel doors
- Side tables keep platters, seasonings, and tools within arm's reach
- Grease Management System with pull out grease tray
- Six tool hooks
- Two front locking castors / Two back swivel casters
- Propane tank inside the cabinet
- Natural gas grill includes a 10-foot flexible hose
- **PureBlu** burners distribute even heat across the entire grate
- Warming rack keeps food warm or toasts buns
- Large cooking surface, space to grill an entire meal at once

1500569	\$899.00	\$1,049.00
GENESIS S-315 GAS GRILL	STAINLESS STEEL	NG
MASTER CARTON: 1		
H: 25.98	W: 30.32	D: 36.06 Wt: 188 Cu.Ft.: 16.4
DIMENSIONS - LID CLOSED		
H: 48.1	W: 57.7	D: 27.0
DIMENSIONS - LID OPEN		
H: 63.0	W: 57.7	D: 30.6



GAS GRILLS

MAP

MSRP

GENESIS E-325 GAS GRILL

1500533

\$849.00

\$999.00

GENESIS E-325 GAS GRILL

BLACK

LP

MASTER CARTON: 1

H: 25.98 W: 30.32 D: 36.06 Wt: 188 Cu.Ft.: 16.4

DIMENSIONS - LID CLOSED

H: 48.1 W: 57.7 D: 27.0

DIMENSIONS - LID OPEN

H: 63.0 W: 57.7 D: 30.6



- Primary Cooking Area = 513 square inches
- Secondary Cooking grate area = 127.5 square inches
- Total Cooking area = 640.5 square inches
- Three stainless steel burners
- 39,000 BTU-per-hour input main burners
- 13,000 BTU-per-hour input **SEAR ZONE** burner
- Compatible with **WEBER CRAFTED** (frame & grillware sold separate)
- **WEBER CRAFTED** cooking grates & frame kit
- Porcelain-enameled, cast-iron grates retain heat for searing
- Stainless steel **FLAVORIZER** bars
- **FLAVORIZER** Bars vaporize juices, boosting grilled flavor
- Flush electronic push button ignition system, 1 AA battery included
- Porcelain-enameled lid with thermometer
- Painted enclosed steel cabinet with painted steel doors
- Side tables keep platters, seasonings, and tools within arm's reach
- Grease Management System with pull out grease tray
- Six tool hooks
- Two front locking castors / Two back swivel casters
- Propane tank inside the cabinet
- Natural gas grill includes a 10-foot flexible hose
- **PureBlu** burners distribute even heat across the entire grate
- Warming rack keeps food warm or toasts buns
- Large cooking surface, space to grill an entire meal at once
- Extra large sear zone has room to cook multiple steaks at once

1500534

\$849.00

\$999.00

GENESIS E-325 GAS GRILL

BLACK

NG

MASTER CARTON: 1

H: 25.98 W: 30.32 D: 36.06 Wt: 188 Cu.Ft.: 16.4

DIMENSIONS - LID CLOSED

H: 48.1 W: 57.7 D: 27.0

DIMENSIONS - LID OPEN

H: 63.0 W: 57.7 D: 30.6



GENESIS E-330 GAS GRILL

1500576

\$949.00

\$1,099.00

GENESIS E-330 GAS GRILL

BLACK

LP

MASTER CARTON: 1

H: 25.98 W: 30.32 D: 42.72 Wt: 200 Cu.Ft.: 19.5

DIMENSIONS - LID CLOSED

H: 48.1 W: 57.7 D: 27.0

DIMENSIONS - LID OPEN

H: 63.0 W: 57.7 D: 30.6



- Primary Cooking Area = 513 square inches
- Secondary Cooking grate area = 127.5 square inches
- Total Cooking area = 640.5 square inches
- Three stainless steel burners
- 39,000 BTU-per-hour input main burners
- 13,000 BTU-per-hour input **SEAR ZONE** burner
- Compatible with **WEBER CRAFTED** (frame & grillware sold separate)
- **WEBER CRAFTED** cooking grates & frame kit
- Porcelain-enameled, cast-iron grates retain heat for searing
- Stainless steel **FLAVORIZER** bars
- **FLAVORIZER** Bars vaporize juices, boosting grilled flavor
- Flush electronic push button ignition system, 1 AA battery included
- Porcelain-enameled lid with thermometer
- Painted enclosed steel cabinet with painted steel doors
- Side tables keep platters, seasonings, and tools within arm's reach
- Grease Management System with pull out grease tray
- Six tool hooks
- Two front locking castors / Two back swivel casters
- Propane tank inside the cabinet
- Natural gas grill includes a 10-foot flexible hose
- **PureBlu** burners distribute even heat across the entire grate
- Warming rack keeps food warm or toasts buns
- Large cooking surface, space to grill an entire meal at once
- Grill locker stores large grillware and grilling tools

1500577

\$949.00

\$1,099.00

GENESIS E-330 GAS GRILL

BLACK

NG

MASTER CARTON: 1

H: 25.98 W: 30.32 D: 42.72 Wt: 200 Cu.Ft.: 19.5

DIMENSIONS - LID CLOSED

H: 48.1 W: 57.7 D: 27.0

DIMENSIONS - LID OPEN

H: 63.0 W: 57.7 D: 30.6



MAP

MSRP

GENESIS E-335 GAS GRILL

1500535	\$1,049.00	\$1,249.00
GENESIS E-335 GAS GRILL	BLACK	LP
MASTER CARTON: 1		
H: 25.98	W: 30.32	D: 42.72 Wt: 205 Cu.Ft.: 19.5
DIMENSIONS - LID CLOSED		
H: 48.1	W: 57.7	D: 27.0
DIMENSIONS - LID OPEN		
H: 63.0	W: 57.7	D: 30.6



- Primary Cooking Area = 513 square inches
- Secondary Cooking grate area = 127.5 square inches
- Total Cooking area = 640.5 square inches
- Three stainless steel burners
- 39,000 BTU-per-hour input main burners
- 13,000 BTU-per-hour input **SEAR ZONE** burner
- 12,000 BTU-per-hour input side burner
- Compatible with **WEBER CRAFTED** (frame & grillware sold separate)
- **WEBER CRAFTED** cooking grates & frame kit
- Porcelain-enameled, cast-iron grates retain heat for searing
- Stainless steel **FLAVORIZER** bars
- **FLAVORIZER** Bars vaporize juices, boosting grilled flavor
- Flush electronic push button ignition system, 1 AA battery included
- Porcelain-enameled lid with thermometer
- Painted enclosed steel cabinet with painted steel doors
- Side tables keep platters, seasonings, and tools within arm's reach
- Grease Management System with pull out grease tray
- Six tool hooks
- Two front locking castors / Two back swivel casters
- Propane tank inside the cabinet
- Natural gas grill includes a 10-foot flexible hose
- **PureBlu** burners distribute even heat across the entire grate
- Warming rack keeps food warm or toasts buns
- Large cooking surface, space to grill an entire meal at once
- Extra large sear zone has room to cook multiple steaks at once
- Grill locker stores large grillware and grilling tools
- Side burner provides extra cooking space for sauces and sides

1500536	\$1,049.00	\$1,249.00
GENESIS E-335 GAS GRILL	BLACK	NG
MASTER CARTON: 1		
H: 25.98	W: 30.32	D: 42.72 Wt: 205 Cu.Ft.: 19.5
DIMENSIONS - LID CLOSED		
H: 48.1	W: 57.7	D: 27.0
DIMENSIONS - LID OPEN		
H: 63.0	W: 57.7	D: 30.6



GENESIS S-335 GAS GRILL

1500537	\$1,149.00	\$1,349.00
GENESIS S-335 GAS GRILL	STAINLESS STEEL	LP
MASTER CARTON: 1		
H: 32.13	W: 30.88	D: 35.75 Wt: 205 Cu.Ft.: 20.5
DIMENSIONS - LID CLOSED		
H: 48.1	W: 57.7	D: 27.0
DIMENSIONS - LID OPEN		
H: 63.0	W: 57.7	D: 30.6



- Primary Cooking Area = 513 square inches
- Secondary Cooking grate area = 127.5 square inches
- Total Cooking area = 640.5 square inches
- Three stainless steel burners
- 39,000 BTU-per-hour input main burners
- 13,000 BTU-per-hour input **SEAR ZONE** burner
- 12,000 BTU-per-hour input side burner
- Compatible with **WEBER CRAFTED** (frame & grillware sold separate)
- **WEBER CRAFTED** cooking grates & frame kit
- 7mm Stainless steel cooking grates heat quickly, are highly durable
- Stainless steel **FLAVORIZER** bars
- **FLAVORIZER** Bars vaporize juices, boosting grilled flavor
- Flush electronic push button ignition system, 1 AA battery included
- Stainless steel lid with thermometer
- Painted enclosed steel cabinet with stainless steel doors
- Side tables keep platters, seasonings, and tools within arm's reach
- Grease Management System with pull out grease tray
- Six tool hooks
- Two front locking castors / Two back swivel casters
- Propane tank inside the cabinet
- Natural gas grill includes a 10-foot flexible hose
- **PureBlu** burners distribute even heat across the entire grate
- Warming rack keeps food warm or toasts buns
- Large cooking surface, space to grill an entire meal at once
- Extra large sear zone has room to cook multiple steaks at once
- Grill locker stores large grillware and grilling tools
- Side burner provides extra cooking space for sauces and sides

1500538	\$1,149.00	\$1,349.00
GENESIS S-335 GAS GRILL	STAINLESS STEEL	NG
MASTER CARTON: 1		
H: 32.13	W: 30.88	D: 35.75 Wt: 205 Cu.Ft.: 20.5
DIMENSIONS - LID CLOSED		
H: 48.1	W: 57.7	D: 27.0
DIMENSIONS - LID OPEN		
H: 63.0	W: 57.7	D: 30.6



GAS GRILLS

MAP

MSRP

GENESIS E-415 GAS GRILL

1500367

\$1,099.00

\$1,299.00

GENESIS E-415 GAS GRILL

BLACK

LP

MASTER CARTON: 1

H: 25.98 W: 33.54 D: 41.7 Wt: 219.16 Cu.Ft.: 21

DIMENSIONS - LID CLOSED

H: 48.1 W: 64.5 D: 27.0

DIMENSIONS - LID OPEN

H: 63.0 W: 64.5 D: 30.6



- Primary Cooking Area = 646 square inches
- Secondary Cooking grate area = 174 square inches
- Total Cooking Area = 820 square inches
- Four stainless steel burners
- 48,000 BTU-per-hour input main burners
- Compatible with **WEBER CRAFTED** (frame & grillware sold separate)
- Porcelain-enameled, cast-iron grates retain heat for searing
- Stainless steel **FLAVORIZER** bars
- **FLAVORIZER** Bars vaporize juices, boosting grilled flavor
- Flush electronic push button ignition system, 1 AA battery included
- Porcelain-enameled lid with thermometer
- Painted enclosed steel cabinet with painted steel doors
- Side tables keep platters, seasonings, and tools within arm's reach
- Grease Management System with pull out grease tray
- Six tool hooks
- Two front locking castors / Two back swivel casters
- Propane tank inside the cabinet
- Natural gas grill includes a 10-foot flexible hose
- **PureBlu** burners distribute even heat across the entire grate
- Warming rack keeps food warm or toasts buns
- Large cooking surface, space to grill an entire meal at once

1500368

\$1,099.00

\$1,299.00

GENESIS E-415 GAS GRILL

BLACK

NG

MASTER CARTON: 1

H: 25.98 W: 33.54 D: 41.7 Wt: 219.16 Cu.Ft.: 21

DIMENSIONS - LID CLOSED

H: 48.1 W: 64.5 D: 27.0

DIMENSIONS - LID OPEN

H: 63.0 W: 64.5 D: 30.6



GENESIS S-415 GAS GRILL

1500539

\$1,199.00

\$1,399.00

GENESIS S-415 GAS GRILL

STAINLESS STEEL

LP

MASTER CARTON: 1

H: 25.98 W: 33.54 D: 41.7 Wt: 219 Cu.Ft.: 21

DIMENSIONS - LID CLOSED

H: 48.1 W: 64.5 D: 27.0

DIMENSIONS - LID OPEN

H: 63.0 W: 64.5 D: 30.6



- Primary Cooking Area = 646 square inches
- Secondary Cooking grate area = 174 square inches
- Total Cooking Area = 820 square inches
- Four stainless steel burners
- 48,000 BTU-per-hour input main burners
- Compatible with **WEBER CRAFTED** (frame & grillware sold separate)
- 7mm Stainless steel cooking grates heat quickly, are highly durable
- Stainless steel **FLAVORIZER** bars
- **FLAVORIZER** Bars vaporize juices, boosting grilled flavor
- Flush electronic push button ignition system, 1 AA battery included
- Stainless steel lid with thermometer
- Painted enclosed steel cabinet with stainless steel doors
- Side tables keep platters, seasonings, and tools within arm's reach
- Grease Management System with pull out grease tray
- Six tool hooks
- Two front locking castors / Two back swivel casters
- Propane tank inside the cabinet
- Natural gas grill includes a 10-foot flexible hose
- **PureBlu** burners distribute even heat across the entire grate
- Warming rack keeps food warm or toasts buns
- Large cooking surface, space to grill an entire meal at once

1500580

\$1,199.00

\$1,399.00

GENESIS S-415 GAS GRILL

STAINLESS STEEL

NG

MASTER CARTON: 1

H: 25.98 W: 33.54 D: 41.7 Wt: 219 Cu.Ft.: 21

DIMENSIONS - LID CLOSED

H: 48.1 W: 64.5 D: 27.0

DIMENSIONS - LID OPEN

H: 63.0 W: 64.5 D: 30.6



MAP

MSRP

36410001 \$1,399.00 \$1,599.00

GENESIS E-435 GAS GRILL BLACK LP

MASTER CARTON: 1

H: 25.98 W: 35.43 D: 45.3 Wt: 220.0 Cu.Ft.: 24.1

DIMENSIONS - LID CLOSED

H: 48.1 W: 68.5 D: 27.0

DIMENSIONS - LID OPEN

H: 62.1 W: 68.5 D: 30.6



38410001 \$1,399.00 \$1,599.00

GENESIS E-435 GAS GRILL BLACK NG

MASTER CARTON: 1

H: 25.98 W: 35.43 D: 45.3 Wt: 220.0 Cu.Ft.: 24.1

DIMENSIONS - LID CLOSED

H: 48.1 W: 68.5 D: 27.0

DIMENSIONS - LID OPEN

H: 62.1 W: 68.5 D: 30.6



GENESIS S-435 GAS GRILL

36400001 \$1,499.00 \$1,699.00

GENESIS S-435 GAS GRILL STAINLESS STEEL LP

MASTER CARTON: 1

H: 32.38 W: 36.0 D: 38.19 Wt: 237.0 Cu.Ft.: 25.8

DIMENSIONS - LID CLOSED

H: 48.1 W: 68.5 D: 27.0

DIMENSIONS - LID OPEN

H: 62.1 W: 68.5 D: 30.6



38400001 \$1,499.00 \$1,699.00

GENESIS S-435 GAS GRILL STAINLESS STEEL NG

MASTER CARTON: 1

H: 32.38 W: 36.0 D: 38.19 Wt: 240.0 Cu.Ft.: 25.8

DIMENSIONS - LID CLOSED

H: 48.1 W: 68.5 D: 27.0

DIMENSIONS - LID OPEN

H: 62.1 W: 68.5 D: 30.6



- Primary Cooking Area = 646 square inches
- Expandable Cooking grate area = 348 square inches
- Total Cooking Area = 994 square inches
- Four stainless steel burners
- 48,000 BTU-per-hour input main burners
- 12,000 BTU-per-hour input **SEAR ZONE** burner
- 12,000 BTU-per-hour input side burner
- **WEBER CRAFTED** cooking grates & frame kit
- 7mm Stainless steel cooking grates heat quickly, are highly durable
- Stainless steel **FLAVORIZER** bars
- **FLAVORIZER** Bars vaporize juices, boosting grilled flavor
- Flush electronic push button ignition system, 1 AA battery included
- Stainless steel lid with thermometer
- Painted enclosed steel cabinet with stainless steel doors
- Extra large prep & serve table
- Grease Management System with pull out grease tray
- Six tool hooks
- Two front locking castors / Two back swivel casters
- Propane tank inside the cabinet
- Natural gas grill includes a 10-foot flexible hose
- **PureBlu** burners distribute even heat across the entire grate
- Warming rack keeps food warm or toasts buns
- Large cooking surface, space to grill an entire meal at once
- Extra large sear zone has room to cook multiple steaks at once
- Grill locker stores large grillware and grilling tools
- Side burner provides extra cooking space for sauces and sides
- One grease scraper included
- Visible front tank scale
- Fuel gauge - LP models only (tank not included)

GAS GRILLS

MAP

MSRP

GENESIS SX-335 SMART GAS GRILL

3560001

\$1,349.00

\$1,549.00

GENESIS SX-335 GAS GRILL

STAINLESS STEEL

LP

MASTER CARTON: 1

H: 32.13 W: 30.88 D: 35.75 Wt: 245.6 Cu.Ft.: 20.5

DIMENSIONS - LID CLOSED

H: 48.1 W: 61.5 D: 27.0

DIMENSIONS - LID OPEN

H: 62.1 W: 61.5 D: 30.6



3760001

\$1,349.00

\$1,549.00

GENESIS SX-335 GAS GRILL

STAINLESS STEEL

NG

MASTER CARTON: 1

H: 32.13 W: 30.88 D: 35.75 Wt: 245.6 Cu.Ft.: 20.5

DIMENSIONS - LID CLOSED

H: 48.1 W: 61.5 D: 27.0

DIMENSIONS - LID OPEN

H: 62.1 W: 61.5 D: 30.6



- Primary Cooking Area = 513 square inches
- Expandable Cooking grate area = 274 square inches
- Total Cooking area = 787 square inches
- Three stainless steel burners
- 39,000 BTU-per-hour input main burners
- 13,000 BTU-per-hour input **SEAR ZONE** burner
- 12,000 BTU-per-hour input side burner
- **WEBER CRAFTED** cooking grates & frame kit
- 7mm Stainless steel cooking grates heat quickly, are highly durable
- Stainless steel **FLAVORIZER** bars
- **FLAVORIZER** Bars vaporize juices, boosting grilled flavor
- Flush electronic push button ignition system, 1 AA battery included
- Stainless steel lid with thermometer
- Painted enclosed steel cabinet with stainless steel doors
- Extra large prep & serve table
- Grease Management System with pull out grease tray
- Six tool hooks
- Two front locking castors / Two back swivel casters
- Propane tank inside the cabinet
- Natural gas grill includes a 10-foot flexible hose
- **PureBlu** burners distribute even heat across the entire grate
- Warming rack keeps food warm or toasts buns
- Large cooking surface, space to grill an entire meal at once
- Extra large sear zone has room to cook multiple steaks at once
- Grill locker stores large grillware and grilling tools
- Side burner provides extra cooking space for sauces and sides
- One grease scraper included
- Visible front tank scale
- Fuel gauge - LP models only (tank not included)
- Integrated **WEBER CONNECT** smart grilling technology:
 - Step-by-step grilling assistance
 - Real time food temperature monitoring
 - WiFi connected for remote grill access
 - Low fuel indications on your phone
 - Integrated ambient thermometer to measure temp of the grill
- Digital LED Display
- Includes one meat probe, two probe capacity

MAP

MSRP

SMOKEY JOE CHARCOAL GRILL

10020	\$45.99	\$50.99
SMOKEY JOE CHARCOAL GRILL	14 INCH	BLACK
MASTER CARTON: 4		
H: 18.1	W: 15.4	D: 32.8 Wt: 37.7 Cu.Ft.: 5.3
DIMENSIONS		
H: 17.0	W: 14.2	D: 14.5



- Cooking area = 147 square inches
- Plated steel cooking grate
- Porcelain-enameled bowl and lid
- Rust-resistant aluminum damper
- One glass-reinforced nylon handle
- Aluminum ash catcher

SMOKEY JOE PREMIUM CHARCOAL GRILL

40020	\$57.00	\$67.00
SMOKEY JOE PREMIUM CHARCOAL GRILL	14 INCH	BLACK
MASTER CARTON: 4		
H: 18.1	W: 16.9	D: 16.2 Wt: 39.3 Cu.Ft.: 5.3
DIMENSIONS		
H: 17.0	W: 14.2	D: 16.5



- Cooking area = 147 square inches
- Plated steel cooking grate
- Porcelain-enameled bowl and lid
- Rust-resistant aluminum damper
- One glass-reinforced nylon handle
- **TUCK-N-CARRY** lid lock doubles as a carry handle and lid holder

1126801	\$67.00	\$77.00
SMOKEY JOE PREMIUM CHARCOAL GRILL	14 INCH	SLATE BLUE
MASTER CARTON: 4		
H: 18.1	W: 16.9	D: 16.2 Wt: 39.3 Cu.Ft.: 5.3
DIMENSIONS		
H: 17.0	W: 14.2	D: 16.5



JUMBO JOE CHARCOAL GRILL

1211001	\$89.00	\$99.00
JUMBO JOE CHARCOAL GRILL	18 INCH	BLACK
MASTER CARTON: 1		
H: 8.8	W: 19.5	D: 19.5 Wt: 18.0 Cu.Ft.: 2.0
DIMENSIONS		
H: 19.7	W: 20.5	D: 19.7



- Cooking area = 240 square inches
- Plated steel cooking grate
- Porcelain-enameled bowl and lid
- Rust-resistant aluminum dampers
- Rust-resistant aluminum ash catcher
- Lid handle with heat shield
- **TUCK-N-CARRY** lid lock doubles as a carry handle and lid holder

PORTABLE GRILLS

MAP

MSRP

GO-ANYWHERE SPLIT GRATE CHARCOAL GRILL

1500763

\$79.99

\$89.99

GO-ANYWHERE CHARCOAL GRILL SPLIT GRATE

BLACK

MASTER CARTON:

H: 9 W: 23.5 D: 12.3 Wt: 14 Cu.Ft.: 5.9

DIMENSIONS

H: 15.0 W: 19.5 D: 11.5



Details coming
soon

GO-ANYWHERE GAS GRILL

1141001

\$89.00

\$99.00

GO-ANYWHERE GAS GRILL

BLACK

MASTER CARTON: 4

H: 14.5 W: 21.0 D: 12.2 Wt: 56.9 Cu.Ft.: 5.9

DIMENSIONS

H: 15.0 W: 19.5 D: 11.5



- Cooking area = 160 square inches
- One stainless steel burner
- 6,500 BTU-per-hour input main burner
- Porcelain-enameled cooking grate
- Porcelain-enameled base and lid
- Three glass-reinforced nylon handles
- Plated steel legs pivot to lock lid in place for carrying
- Push-button igniter
- Uses disposable 14.1 oz. LP cylinders (not included)

MAP

MSRP

JUMBO JOE PREMIUM

1321001

\$99.00

\$109.00

JUMBO JOE PREMIUM CHARCOAL GRILL

22 INCH BLACK

MASTER CARTON: 1

H: 9.87 W: 23.9 D: 23.9 Wt: 28 Cu.Ft.: 3.25

DIMENSIONS - LID CLOSED

H: 38.6 W: 22 D: 24.8



- 363 sq in cooking area
- Porcelain-enameled lid and bowl for extreme durability
- Plated-steel cooking grate with 2-year warranty
- Holes at base of bowl allow for sweeping cooled ashes into ash catcher
- Rust-resistant aluminum ash catcher makes quick work of clean up
- Rust-resistant aluminum lid damper adjusts for maximum heat control
- Heat shield lid handle protect hands from heat
- Lid hook inside grill lid
- The premium charcoal grill has 1 glass-reinforced nylon handle
- Durable all weather wheels

CHARCOAL GRILLS

MAP

MSRP

ORIGINAL KETTLE CHARCOAL GRILL

441001

\$119.00

\$129.00

ORIGINAL KETTLE CHARCOAL GRILL

18 INCH BLACK

MASTER CARTON: 1

H: 14.8 W: 20.5 D: 20.5 Wt: 21.0 Cu.Ft.: 3.5

DIMENSIONS

H: 36.0 W: 23.0 D: 18.5



- 18 inch cooking area = 240 square inches
- 22 inch cooking area = 363 square inches
- Plated steel cooking grate
- Porcelain-enameled bowl and lid
- Aluminized steel **ONE-TOUCH** cleaning system
- Rust-resistant ash catcher
- Rust-resistant aluminum damper
- Glass-reinforced nylon bowl handle
- Glass-reinforced nylon lid handle with heat shield
- Spring clip/push pin leg assembly
- Durable all-weather wheels
- Angled lid hook inside grill lid

741001

\$139.00

\$149.00

ORIGINAL KETTLE CHARCOAL GRILL

22 INCH BLACK

MASTER CARTON: 1

H: 15.0 W: 24.5 D: 24.5 Wt: 37.0 Cu.Ft.: 5.1

DIMENSIONS

H: 39.5 W: 25.0 D: 22.5



ORIGINAL KETTLE PREMIUM CHARCOAL GRILL

14401001

\$219.00

\$269.00

ORIGINAL KETTLE PREMIUM CHARCOAL GRILL

22 INCH BLACK

MASTER CARTON: 1

H: 15.0 W: 24.5 D: 24.5 Wt: 37.0 Cu.Ft.: 5.1

DIMENSIONS

H: 39.5 W: 27.0 D: 22.5



- Cooking area = 363 square inches
- Plated steel, hinged cooking grate
- Porcelain-enameled bowl and lid
- Aluminized steel **ONE-TOUCH** cleaning system
- Removable, high-capacity, aluminum ash catcher
- Rust-resistant aluminum damper
- Glass-reinforced nylon bowl handles with tool hooks
- Glass-reinforced nylon lid handle with heat shield
- Spring clip/push pin leg assembly
- Durable all-weather wheels
- Angled lid hook inside grill lid
- Built-in lid thermometer

COLORS

\$239.00

\$289.00

14402001

COPPER



14407001

GREEN



CHARCOAL GRILLS

MAP

MSRP

MASTER-TOUCH 26" CHARCOAL GRILL

1500064	\$459.00	\$559.00
MASTER-TOUCH CHARCOAL GRILL	26 INCH	BLACK
MASTER CARTON: 1		
H: 21.5	W: 29	D: 29 Wt: 71.4 Cu.Ft.: 10.5
DIMENSIONS - LID CLOSED		
H: 42.9	W: 27	D: 33
 0 77924 99060 1		

COLORS	\$479.00	\$579.00
---------------	----------	----------

1500065

SMOKE



- **WEBER CRAFTED** stainless-steel cooking grate included
- Large grilling surface has space for entrees, sides, and more
- Bottom damper smoke setting creates ideal airflow for smoking
- **ONE-TOUCH** stainless-steel cleaning system makes clean up easy
- Porcelain-enameled lid and bowl retain heat, won't rust or peel
- Lid holder keeps the lid on the side of the grill
- Built-in lid thermometer displays internal temperature of grill
- Charcoal rails hold charcoal in place for smoking or searing
- Tool hooks keep spatulas, tongs, and cleaning brush, handy
- Stainless-steel hinged cooking grate makes adding charcoal easy
- Warming rack keeps food warm or toasts buns

CHARCOAL GRILLS

MAP

MSRP

MASTER-TOUCH CHARCOAL GRILL

14501001

\$275.00

\$325.00

MASTER-TOUCH CHARCOAL GRILL

22 INCH BLACK

MASTER CARTON: 1

H: 15.0 W: 24.5 D: 24.5 Wt: 47.0 Cu.Ft.: 5.1

DIMENSIONS - LID CLOSED

H: 42.0 W: 24.0 D: 29.5



COLORS

\$299.00

\$349.00

14516001

DEEP OCEAN BLUE



14505601

IVORY



14510601

SMOKE



14511601

SPRING GREEN



14513601

SLATE



- Primary cooking area = 363 square inches
- Warming rack area = 80 square inches
- Total cooking area = 443 square inches
- **GOURMET BBQ SYSTEM** hinged cooking grate
- Porcelain-enameled bowl and lid
- Aluminized steel **ONE-TOUCH** cleaning system
- Removable, high-capacity, aluminum ash catcher
- Rust-resistant aluminum damper
- Glass-reinforced nylon bowl handle with tool hooks
- Glass-reinforced nylon lid handle with heat shield
- Spring clip/push pin leg assembly
- Durable all-weather 8 inch rubber molded wheels
- **TUCK-AWAY** lid holder
- Two **CHAR-RAILS** charcoal fuel holders
- Built-in lid thermometer

MAP

MSRP

PERFORMER CHARCOAL GRILL

15301001

\$349.00

\$449.00

PERFORMER CHARCOAL GRILL

22 INCH BLACK

MASTER CARTON: 1

H: 17.5 W: 32.3 D: 27.0 Wt: 70.0 Cu.Ft.: 8.7

DIMENSIONS - LID CLOSED

H: 43.5 W: 42.0 D: 29.0



0 77924 03251 6



- Cooking area = 363 square inches
- **GOURMET BBQ SYSTEM** hinged cooking grate
- Porcelain-enameled bowl and lid
- Aluminized steel **ONE-TOUCH** cleaning system
- Removable, high-capacity, aluminum ash catcher
- **TUCK-AWAY** lid holder
- Rust-resistant aluminum damper
- Lid handle with heat shield
- Painted, metal fold-down table
- Heavy-duty steel cart frame
- Three tool hooks
- Built-in lid thermometer
- Wire bottom shelf
- Two durable all-weather wheels with full wheel hubs
- Two locking casters

PERFORMER PREMIUM CHARCOAL GRILL

15401001

\$499.00

\$599.00

PERFORMER PREMIUM CHARCOAL GRILL

22 INCH BLACK

MASTER CARTON: 1

H: 20.3 W: 38.8 D: 27.3 Wt: 95.0 Cu.Ft.: 12.3

DIMENSIONS - LID CLOSED

H: 44.1 W: 48.0 D: 30.0



0 77924 03253 0



- Cooking area = 363 square inches
- **GOURMET BBQ SYSTEM** hinged cooking grate
- Porcelain-enameled bowl and lid
- Aluminized steel **ONE-TOUCH** cleaning system
- Removable, high-capacity, aluminum ash catcher
- **TUCK-AWAY** lid holder
- Rust-resistant aluminum damper
- Lid handle with heat shield
- Removable backlit LCD cook timer
- Two **CHAR-BASKET** charcoal fuel holders
- Painted, metal work table
- Heavy-duty steel cart frame
- Three tool hooks
- Built-in lid thermometer
- Weather-protected **CHARBIN** storage container
- Wire bottom shelf
- Two durable all-weather 8 inch rubber molded wheels
- Two locking casters

CHARCOAL GRILLS

MAP

MSRP

PERFORMER DELUXE CHARCOAL GRILL

15501001

\$549.00

\$649.00

PERFORMER DELUXE CHARCOAL GRILL

22 INCH BLACK

MASTER CARTON: 1

H: 20.3 W: 38.8 D: 27.3 Wt: 99.0 Cu.Ft.: 12.3

DIMENSIONS - LID CLOSED

H: 44.1 W: 48.0 D: 30.0



0 77924 03235 6

15502001

\$579.00

\$679.00

PERFORMER DELUXE CHARCOAL GRILL

22 INCH COPPER

MASTER CARTON: 1

H: 20.3 W: 38.8 D: 27.3 Wt: 99.0 Cu.Ft.: 12.3

DIMENSIONS - LID CLOSED

H: 44.1 W: 48.0 D: 30.0



0 77924 03237 0

15507001

\$579.00

\$679.00

PERFORMER DELUXE CHARCOAL GRILL

22 INCH GREEN

MASTER CARTON: 1

H: 20.3 W: 38.8 D: 27.3 Wt: 99.0 Cu.Ft.: 12.3

DIMENSIONS - LID CLOSED

H: 44.1 W: 48.0 D: 30.0



0 77924 03240 0



- Cooking area = 363 square inches
- **GOURMET BBQ SYSTEM** hinged cooking grate
- Electronic **TOUCH-N-GO** gas ignition system
- Porcelain-enameled bowl and lid
- Aluminized steel **ONE-TOUCH** cleaning system
- Removable, high-capacity, aluminum ash catcher
- **TUCK-AWAY** lid holder
- Rust-resistant aluminum damper
- Lid handle with heat shield
- Removable backlit LCD cook timer
- Two **CHAR-BASKET** charcoal fuel holders
- Painted, metal work table
- Heavy-duty steel cart frame
- Three tool hooks
- Built-in lid thermometer
- Weather-protected **CHARBIN** storage container
- Wire bottom shelf
- Two durable all-weather 8 inch rubber molded wheels
- Two locking casters
- Uses disposable 14.1 or 16.4 oz. LP cylinders (sold separately)

MAP

MSRP

SUMMIT KAMADO E6 GRILL

18201001

\$1,249.00

\$1,449.00

SUMMIT KAMADO E6 CHARCOAL GRILL

24 INCH BLACK

MASTER CARTON: 1

H: 29.3 W: 36.8 D: 30.6 Wt: 142.0 Cu.Ft.: 18.7

DIMENSIONS - LID CLOSED

H: 44.9 W: 34.8 D: 35.8

DIMENSIONS - LID OPEN

H: 59.4 W: 34.8 D: 35.8



- Cooking area = 452 square inches
- **GOURMET BBQ SYSTEM** stainless steel hinged cooking grate
- Stainless steel diffuser plate
- Two position fuel grate
- Air-insulated double-walled porcelain-enameled lid and bowl
- **RAPIDFIRE** lid damper
- Lid thermometer
- Easy open lid hinge
- Stainless steel **ONE-TOUCH** cleaning system
- Removable, high-capacity, aluminum ash catcher
- Smoke/low and slow vent setting
- Two **CHAR-BASKET** charcoal fuel holders
- Two tool hooks
- Bottom wire rack & diffuser plate storage area
- Two swivel casters
- One locking caster

SUMMIT KAMADO S6 GRILL CENTER GRILL

18501101

\$2,149.00

\$2,449.00

SUMMIT KAMADO S6 CHARCOAL GRILL

24 INCH BLACK

MASTER CARTON: 1

H: 35.0 W: 57.0 D: 30.5 Wt: 238.0 Cu.Ft.: 32.4

DIMENSIONS - LID CLOSED

H: 47.7 W: 56.6 D: 35.0

DIMENSIONS - LID OPEN

H: 62.2 W: 56.6 D: 35.0



- Cooking area = 452 square inches
- **GOURMET BBQ SYSTEM** stainless steel hinged cooking grate
- Stainless steel diffuser plate
- Two position fuel grate
- **SNAP-JET** gas ignition system
- Air-insulated double-walled porcelain-enameled lid and bowl
- **RAPIDFIRE** lid damper
- Lid thermometer
- Easy open lid hinge
- Stainless steel **ONE-TOUCH** cleaning system
- Removable, high-capacity, aluminum ash catcher
- Smoke/low and slow vent setting
- Two **CHAR-BASKET** charcoal fuel holders
- Stainless steel tabletop
- Stainless steel wire basket
- Three stainless steel tool hooks
- Fuel Bag included
- Bottom wire rack
- Diffuser plate storage area
- Two durable all-weather 8 inch rubber molded wheels
- Two locking casters
- Uses disposable 14.1 or 16.4 oz. LP cylinders (sold separately)

CHARCOAL GRILLS

MAP

MSRP

SMOKEY MOUNTAIN COOKER SMOKER

711001

\$279.00

\$329.00

SMOKEY MOUNTAIN COOKER SMOKER

14 INCH BLACK

MASTER CARTON: 1

H: 23.5 W: 18.0 D: 17.8 Wt: 29.0 Cu.Ft.: 4.5

DIMENSIONS

H: 31.4 W: 14.7 D: 14.7



721001

\$419.00

\$519.00

SMOKEY MOUNTAIN COOKER SMOKER

18 INCH BLACK

MASTER CARTON: 1

H: 29.5 W: 21.8 D: 21.5 Wt: 51.0 Cu.Ft.: 8.2

DIMENSIONS

H: 41.7 W: 19.7 D: 19.7



- 14 inch cooking area = 286 square inches
- 18 inch cooking area = 481 square inches
- 22 inch cooking area = 726 square inches
- Two plated steel cooking grates
- Porcelain-enameled bowl, lid, center section, and water pan
- Charcoal chamber
- Built-in lid thermometer
- Silicone temperature grommet
- Four rust-resistant aluminum dampers
- Rust-resistant aluminum fuel door
- Glass-reinforced nylon handle(s)
- Rust-resistant aluminum heat shield
- Cover included

731001

\$549.00

\$649.00

SMOKEY MOUNTAIN COOKER SMOKER

22 INCH BLACK

MASTER CARTON: 1

H: 35.0 W: 27.0 D: 26.5 Wt: 78.0 Cu.Ft.: 13.8

DIMENSIONS

H: 48.5 W: 23.0 D: 24.0



RANCH KETTLE

60020

\$1,849.00

\$2,099.00

RANCH KETTLE

37 INCH BLACK

MASTER CARTON: 1

H: 19.0 W: 42.3 D: 42.0 Wt: 152.0 Cu.Ft.: 19.9

DIMENSIONS

H: 42.0 W: 37.7 D: 44.7















- Cooking area = 1,104 square inches
- Stainless steel hinged cooking grate
- Porcelain-enameled bowl and lid
- **TUCK-AWAY** lid holder
- Rust-resistant aluminum dampers
- Removable ash catcher
- Heavy-duty steel cart
- Two glass-reinforced nylon handles
- Two locking casters
- Two durable all-weather wheels with full wheel hubs

MAP

MSRP

COOKING: SMART GRILLING











3201	WEBER CONNECT SMART GRILLING HUB	\$139.99	\$149.99		
	<ul style="list-style-type: none"> • Compatible with any grill • One meat probe, one ambient probe included • Four probe capacity • USB rechargeable battery • WiFi and Bluetooth® enabled • Free iOS & Android app • 9 Segmented LED Display • Embedded magnet 	MASTER CARTON: 4			
		H: 6.38 W: 6.0 D: 12.8 Wt: 4.0 Cu.Ft.: 0.28			
		INDIVIDUAL CARTON:			
		H: 5.52 W: 5.52 D: 2.8 Wt: 1.0			
OUT OF CARTON:					
H: 3.9 W: 2.9 D: 1.4					
3250	WEBER CONNECT STORAGE AND TRAVEL CASE	\$40.49	\$45.49		
	<ul style="list-style-type: none"> • Stores WEBER CONNECT Hub and accessories • Shockproof EVA foam interior provides secure fit and protection • Durable exterior material is stain resistant and dust proof 	MASTER CARTON: 4			
		H: 10.25 W: 9.06 D: 12.2 Wt: 4.03 Cu.Ft.: 0.65			
		INDIVIDUAL CARTON:			
		H: 8.9 W: 8.46 D: 2.95 Wt: 0.84			
OUT OF CARTON:					
H: 8.8 W: 9.0 D: 2.8					
3254	WEBER CONNECT 6-PIECE MOUNTING KIT	\$40.49	\$45.49		
	<ul style="list-style-type: none"> • Attachment kit for mounting WEBER CONNECT Hub to charcoal, smokers and gas grills • Keep WEBER CONNECT Hub close-by while grilling • Includes bag for convenient storage 	MASTER CARTON: 4			
		H: 6.3 W: 5.63 D: 8.27 Wt: 2.45 Cu.Ft.: 0.16			
		INDIVIDUAL CARTON:			
		H: 5.58 W: 5.24 D: 1.97 Wt: 0.73			
OUT OF CARTON:					
H: 6.75 W: 6.25 D: 1.5					
7202	iGRILL MINI	\$54.99			
	<ul style="list-style-type: none"> • App-connected thermometer • Bluetooth® smart connection • Single probe capability (one Meat Probe included) • Smart LED • 150-hour battery life (battery included) • Hand wash only 	MASTER CARTON: 5			
		H: 8.23 W: 4.37 D: 13.51 Wt: 3.0 Cu.Ft.: 0.28			
		INDIVIDUAL CARTON:			
		H: 7.4 W: 3.86 D: 2.56 Wt: 0.45			
OUT OF CARTON:					
H: 2 W: 1.6 D: 1.5					
7203	iGRILL 2	\$109.99			
	<ul style="list-style-type: none"> • App-connected thermometer • Bluetooth® smart connection • Four probe capability (two Meat Probes included) • LED temperature read out • 200-hour battery life (batteries included) • Hand wash only 	MASTER CARTON: 5			
		H: 9.65 W: 7.75 D: 14.4 Wt: 6.0 Cu.Ft.: 0.62			
		INDIVIDUAL CARTON:			
		H: 7.19 W: 8.86 D: 2.75 Wt: 1.0			
OUT OF CARTON:					
H: 2.2 W: 3.2 D: 2.2					
3400322	PREMIUM WIRED AMBIENT PROBE	\$24.99	\$27.99		
	<p style="text-align: center;">Details coming soon</p>	MASTER CARTON: 6			
		H: 9 W: 4.1 D: 5.6 Wt: 0.9 Cu.Ft.: 0.1			
		INDIVIDUAL CARTON:			
		H: 6.8 W: 0.8 D: 3.4 Wt:			
OUT OF CARTON:					
H: 0.6 W: 0.6 D: 3.3					

ACCESSORIES



MAP

MSRP



COOKING: THERMOMETERS



<p>3400321 PREMIUM WIRED FOOD PROBE</p> 	<ul style="list-style-type: none"> Quickly registers temperatures for fast readout Streamlined, thin design for easy food insertion Accurate temperature readings Durable construction withstands temperature up to 572°F Compatible with SEARWOOD pellet grills and SUMMIT Smart gas grills 	<p style="text-align: right;">\$24.99 \$27.99</p> <p>MASTER CARTON: 6 H: 9 W: 4.1 D: 5.6 Wt: 0.9 Cu.Ft.: 0.1</p> <p>INDIVIDUAL CARTON: H: 6.8 W: 0.8 D: 3.4 Wt:</p> <p>OUT OF CARTON: H: 0.6 W: 0.6 D: 4.7</p>	 <p>0 77924 00286 1</p>
<p>3400324 WIRED FOOD PROBE</p> 	<ul style="list-style-type: none"> Quickly registers temperatures for fast readout Streamlined, thin design for easy food insertion Accurate temperature readings Durable construction withstands temperature up to 572°F Compatible with SEARWOOD pellet grills and SUMMIT Smart gas grills 	<p style="text-align: right;">\$19.99 \$22.99</p> <p>MASTER CARTON: 6 H: 9 W: 4.1 D: 5.6 Wt: 0.8 Cu.Ft.: 0.1</p> <p>INDIVIDUAL CARTON: H: 6.8 W: 0.8 D: 3.4 Wt:</p> <p>OUT OF CARTON: H: 0.6 W: 0.6 D: 4.7</p>	 <p>0 77924 00288 5</p>
<p>3400516 WIRED BLUETOOTH PROBE</p> <p style="text-align: center;">Image coming soon</p>	<p style="text-align: center;">Details coming soon</p>	<p style="text-align: right;">\$29.99 \$34.99</p> <p>MASTER CARTON: 5 H: 9.6 W: 4.5 D: 11 Wt: 7 Cu.Ft.: 0.3</p> <p>INDIVIDUAL CARTON: H: 9 W: 4 D: 2 Wt:</p> <p>OUT OF CARTON: H: 6.0 W: 3.0 D: 0.05</p>	 <p>0 77924 01588 5</p>
<p>7211 MEAT TEMPERATURE PROBE</p> 	<ul style="list-style-type: none"> Monitors the internal temperature of your food as it grills One meat temperature probe included Four color-coded sleeves included Hand wash only Stainless steel Compatible with iGRILL, WEBER CONNECT devices, and GENESIS Smart Gas Grills 	<p style="text-align: right;">\$16.49</p> <p>MASTER CARTON: 5 H: 8.0 W: 5.38 D: 5.57 Wt: 1.35 Cu.Ft.: 0.14</p> <p>INDIVIDUAL CARTON: H: 7.32 W: 4.57 D: 0.82 Wt: 0.18</p> <p>OUT OF CARTON: H: 2.6 W: 0.5 D: 5.0</p>	 <p>0 77924 05217 0</p>
<p>7212 AMBIENT TEMPERATURE PROBE</p> 	<ul style="list-style-type: none"> Monitors the internal temperature of your food as it grills One meat temperature probe included Four color-coded sleeves included Hand wash only Stainless steel Compatible with iGRILL, WEBER CONNECT devices, and GENESIS Smart Gas Grills 	<p style="text-align: right;">\$16.49</p> <p>MASTER CARTON: 5 H: 8.0 W: 5.38 D: 5.88 Wt: 1.35 Cu.Ft.: 0.14</p> <p>INDIVIDUAL CARTON: H: 7.32 W: 4.57 D: 0.82 Wt: 0.18</p> <p>OUT OF CARTON: H: 2.6 W: 0.5 D: 4.3</p>	 <p>0 77924 05218 7</p>
<p>6750 INSTANT READ THERMOMETER</p> 	<ul style="list-style-type: none"> Fast, accurate readings in Fahrenheit or Celsius 	<p style="text-align: right;">\$16.99 \$19.99</p> <p>MASTER CARTON: 6 H: 9.88 W: 3.46 D: 9.8 Wt: 1.2 Cu.Ft.: 0.19</p> <p>INDIVIDUAL CARTON: H: 8.75 W: 2.94 D: 1.47 Wt: 0.14</p> <p>OUT OF CARTON: H: 8.0 W: 1.3 D: 0.3</p>	 <p>0 77924 04839 5</p>



COOKING: THERMOMETERS



3400016	INFRARED THERMOMETER		\$64.99	\$74.99	 0 77924 98932 2		
	<ul style="list-style-type: none"> • Quickly and accurately displays griddle surface temperature • Detects temperature from a distance • Easy-to-read display • Comfort grip for ease of use • Auto-shutoff function helps extend battery life 	MASTER CARTON: 6					
		H: 8.54	W: 14.33	D: 6.61		Wt: 4.6	Cu.Ft.: 0.47
		INDIVIDUAL CARTON:					
		H: 7.83	W: 6.02	D: 2.17	Wt: 0.66		
		OUT OF CARTON:					
		H: 6.1	W: 1.92	D: 3.94			

COOKING: GRILLING TOOLS

6320	GRILLING SKEWER SET		\$10.49	\$13.49	 0 77924 15963 3		
	<ul style="list-style-type: none"> • Set of 8 skewers • Dual-pronged design to prevent food from turning • Easily pierces food without damage • Hand wash only 	MASTER CARTON: 6					
		H: 13.88	W: 5.57	D: 4.32		Wt: 3.17	Cu.Ft.: 0.19
		INDIVIDUAL CARTON:					
		H: 13.1	W: 2.5	D: 1.3	Wt: 0.5		
		OUT OF CARTON:					
		H: 13.0	W: 1.25	D: 1.0			

6768	PRECISION GRILL TONGS		\$21.49	\$24.49	 0 77924 16230 5		
	<ul style="list-style-type: none"> • Flat, front edge design for precision control and better handling of food • Durable, stainless steel construction • Soft-touch handle for non-slip grip • Hands-free locking mechanism for ease of use and compact storage • Dishwasher safe for easy cleaning • Metal loop allows hanging storage • 2-year warranty 	MASTER CARTON: 4					
		H: 24.53	W: 5.04	D: 10.24		Wt: 5.55	Cu.Ft.: 0.73
		INDIVIDUAL CARTON:					
		H: 22.84	W: 4.26	D: 1.78	Wt: 0.94		
		OUT OF CARTON:					
		H: 18.0	W: 1.73	D: 2.0			

6769	PRECISION GRILL SPATULA		\$19.99	\$22.99	 0 77924 16229 9		
	<ul style="list-style-type: none"> • 3-sided beveled edge design for easy approach and precision flip • Durable, stainless steel construction • Soft-touch handle designed for non-slip grip • Dishwasher safe for easy cleaning • Metal loop allows hanging storage • 2-year warranty 	MASTER CARTON: 4					
		H: 20.68	W: 6.19	D: 12.09		Wt: 5.71	Cu.Ft.: 0.9
		INDIVIDUAL CARTON:					
		H: 19.69	W: 5.82	D: 2.17	Wt: 0.96		
		OUT OF CARTON:					
		H: 18.0	W: 4.25	D: 2.13			













6770	PRECISION WIDE GRILL SPATULA		\$26.99	\$31.99	 0 77924 16231 2		
	<ul style="list-style-type: none"> • 3-sided beveled edge design for easy approach and precision flip • Durable, stainless steel construction • Soft-touch handle designed for non-slip grip • Dishwasher safe for easy cleaning • Metal loop allows hanging storage • 2-year warranty 	MASTER CARTON: 4					
		H: 20.99	W: 8.04	D: 12.41		Wt: 6.99	Cu.Ft.: 1.21
		INDIVIDUAL CARTON:					
		H: 19.69	W: 7.29	D: 2.17	Wt: 1.04		
		OUT OF CARTON:					
		H: 18.0	W: 6.5	D: 2.3			

ACCESSORIES













MAP

MSRP

COOKING: GRILLING TOOLS

<p>6771 PRECISION GRILL TONGS & SPATULA SET</p>  <ul style="list-style-type: none"> • Includes Precision Grill Tongs and Spatula • Designed for precision control and better handling of food • 3-sided beveled edge design for easy approach and precision flip • Hands-free locking tongs for ease of use and compact storage • Durable, stainless steel construction • Soft-touch handle designed for non-slip grip • Dishwasher safe for easy cleaning • Metal loop allows hanging storage • 2-year warranty 	<p>MASTER CARTON: 4 H: 24.53 W: 8.86 D: 12.21 Wt: 10.07 Cu.Ft.: 1.54 INDIVIDUAL CARTON: H: 22.84 W: 8.23 D: 2.17 Wt: 1.85 OUT OF CARTON: (Spatula) H: W: D: (Tongs) H: W: D:</p>	<p>\$40.49 \$45.49</p>  <p>0 77924 16232 9</p>
<p>6772 PRECISION 3-PIECE GRILL TOOL SET</p>  <ul style="list-style-type: none"> • Includes Precision Grill Tongs, Spatula and Basting Brush • Designed for precision control and better handling of food • 3-sided beveled edge design for easy approach and precision flip • Hands-free locking tongs for ease of use and compact storage • Full-size silicone basting brush • Soft-touch handle designed for non-slip grip • Dishwasher safe for easy cleaning • Metal loop allows hanging storage • 2-year warrant 	<p>MASTER CARTON: 4 H: 24.53 W: 11.42 D: 12.21 Wt: 11.85 Cu.Ft.: 1.98 INDIVIDUAL CARTON: H: 22.84 W: 10.64 D: 2.17 Wt: 2.28 OUT OF CARTON: Spatula: Tongs: Brush:</p>	<p>\$46.99 \$51.99</p>  <p>0 77924 16233 6</p>
<p>6645 PREMIUM TOOL SET</p>  <ul style="list-style-type: none"> • Compact size is perfect for camping, picnics, and urban dwellers • Set includes spatula and locking tongs • Stainless steel 	<p>MASTER CARTON: 4 H: 12.25 W: 6.63 D: 18.19 Wt: 7.6 Cu.Ft.: 0.85 INDIVIDUAL CARTON: H: 17.75 W: 5.9 D: 2.75 Wt: 1.89 OUT OF CARTON: (Spatula) H: 14 W: 3.3 D: 1.2 (Tongs) H: 15 W: 3 D: 1.6</p>	<p>\$33.49 \$38.49</p>  <p>0 77924 01119 1</p>
<p>6707 DELUXE TOOL SET</p>  <ul style="list-style-type: none"> • Ergonomic design and soft-touch grip provide excellent control • Hands-free locking tongs • Set includes spatula and tongs • Stainless steel 	<p>MASTER CARTON: 4 H: 21.5 W: 6.63 D: 11.19 Wt: 10.16 Cu.Ft.: 0.92 INDIVIDUAL CARTON: H: 21.1 W: 6.1 D: 2.6 Wt: 2.54 OUT OF CARTON: (Spatula) H: 18 W: 3.5 D: 4.5 (Tongs) H: 17 W: 1.2 D: 1.6</p>	<p>\$47.99 \$52.99</p>  <p>0 77924 02149 7</p>
<p>6608 BAMBOO SKEWERS</p>  <ul style="list-style-type: none"> • Disposable bamboo skewers • Set of 25 	<p>MASTER CARTON: 12 H: 14.19 W: 4.07 D: 9.19 Wt: 2.83 Cu.Ft.: 0.3 INDIVIDUAL CARTON: H: 13.5 W: 3.0 D: 0.63 Wt: 0.19 OUT OF CARTON: H: 9.8 W: 0.4 D: 0.1</p>	<p>\$5.49 \$6.49</p>  <p>0 77924 02194 7</p>
<p>6319 GRILL BASTING BRUSH</p>  <ul style="list-style-type: none"> • Silicone bristles hold sauces and juices for basting • Dishwasher safe for easy cleaning • Loop to hang brush for easy storage • 1-year warranty 	<p>MASTER CARTON: 4 H: 17.25 W: 5.04 D: 2.91 Wt: 1.53 Cu.Ft.: 0.15 INDIVIDUAL CARTON: H: 15.8 W: 1.2 D: 1.7 Wt: 0.3 OUT OF CARTON: H: 18 W: 1.7 D: 1.0</p>	<p>\$10.63 \$13.63</p>  <p>0 77924 15962 6</p>

COOKING: GRIDDLE TOOLS



3400164	GRIDDLE WARMING RACK FITS 30" GRIDDLE	\$54.99 \$64.99	 0 77924 99321 3
	<ul style="list-style-type: none"> • Adds 100 square inches in cook space • Compatible with 30" Griddles • Narrow slits prevent food from falling • Highly durable construction 	MASTER CARTON: 1	
		H: 3.5 W: 10.3 D: 32.8 Wt: 15 Cu.Ft.: 0.7	
		INDIVIDUAL CARTON:	
		H: 3.5 W: 10.3 D: 32.8 Wt:	
OUT OF CARTON:		H: 30.7 W: 8.9 D: 2.9	
3400165	GRIDDLE WARMING RACK FITS 36" GRIDDLE	\$64.99 \$74.99	 0 77924 99322 0
	<ul style="list-style-type: none"> • Adds 120 square inches in cook space • Compatible with 36" Griddles • Narrow slits prevent food from falling • Highly durable construction 	MASTER CARTON: 1	
		H: 3.5 W: 10.3 D: 38.8 Wt: 17 Cu.Ft.: 0.8	
		INDIVIDUAL CARTON:	
		H: 3.5 W: 10.3 D: 38.8 Wt:	
OUT OF CARTON:		H: 37 W: 8.9 D: 2.9	
3400423	GRIDDLE SCOOP	\$29.99 \$34.99	 0 77924 01451 2
	<ul style="list-style-type: none"> • Wide design fits a large amount of smaller foods • Raised edges keep food contained while removing • Cleans easily in a dishwasher • Non-slip handle for a secure grip while scooping food 	MASTER CARTON: 6	
		H: 18.5 W: 7.5 D: 17.8 Wt: 8.8 Cu.Ft.: 1.4	
		INDIVIDUAL CARTON:	
		H: 17.4 W: 6.6 D: 2.8 Wt:	
OUT OF CARTON:		H: 5.7 W: 16.5 D: 6.3	
3400424	GRIDDLE SPATULA SET	\$29.99 \$34.99	 0 77924 01452 9
	<ul style="list-style-type: none"> • Lightweight, flexible design for mixing, stirring, and handling food • Rounded corners can scoop spreads, sauces, and butter • Beveled front edge easily slides under food • Hold spatulas securely with easy grip handle 	MASTER CARTON: 6	
		H: 17.2 W: 6 D: 14.2 Wt: 6.3 Cu.Ft.: 0.8	
		INDIVIDUAL CARTON:	
		H: 16.3 W: 5.1 D: 2 Wt:	
OUT OF CARTON:		H: W: D:	
3400425	FLAT-GRIP TONGS	\$16.99 \$19.99	 0 77924 01453 6
	<ul style="list-style-type: none"> • Smooth surface grips and keeps delicate foods intact • Angled design provides a comfortable position when gripping paper towels for cleaning and seasoning • Non-slip handle for a secure grip while sliding under stuck-on food • Cleans easily in a dishwasher 	MASTER CARTON: 6	
		H: 19 W: 5.7 D: 16.9 Wt: 6.2 Cu.Ft.: 1.1	
		INDIVIDUAL CARTON:	
		H: 18.2 W: 4.8 D: 2.6 Wt:	
OUT OF CARTON:		H: 2.2 W: 15.7 D: 2.9	
3400426	XL BASTING DOME	\$54.99 \$64.99	 0 77924 01454 3
	<ul style="list-style-type: none"> • Melts Cheese and steam veggies • Covers four standard burgers • T-shaped handle fore ease of use • Dishwasher safe 	MASTER CARTON: 4	
		H: 8.5 W: 13.7 D: 7.9 Wt: 6.1 Cu.Ft.: 0.5	
		INDIVIDUAL CARTON:	
		H: 7.3 W: 9.1 D: 1.4 Wt:	
OUT OF CARTON:		H: 4.9 W: 17.1 D: 10.1	



ACCESSORIES



MAP



MSRP



COOKING: GRIDDLE TOOLS



6776	GRIDDLE ESSENTIAL SET	\$59.99	\$69.99	
		<ul style="list-style-type: none"> • Griddle Spatula flips and moves heavier food with ease (1) • Griddle Scraper effectively removes grease and grime (1) • Flexible Griddle Spatula easily slides under delicate foods, like seafood and veggies (1) • Griddle Squeeze Bottles (2) 		
MASTER CARTON: 2 H: 17.72 W: 12.6 D: 8.47 Wt: 7.17 Cu.Ft.: 1.09				
INDIVIDUAL CARTON: H: 17.13 W: 12.21 D: 3.86 Wt: 3.0				
OUT OF CARTON: HxWxD Spatula: 16.4 x 4.0 x 4.3 Scraper: 12.4 x 5.5 x 1.1 Flexible Spatula: 15.5 x 3.8 x 3.2 Bottle: 7.7 x 2.8 x 2.8				

6777	GRIDDLE STARTER SET	\$40.99	\$45.99	
		<ul style="list-style-type: none"> • Griddle Spatula flips and moves heavier food with ease (1) • Griddle Scraper effectively removes grease and grime (1) • Griddle Squeeze Bottle (1) • Dishwasher safe and BPA Free 		
MASTER CARTON: 2 H: 17.72 W: 9.45 D: 8.47 Wt: 5.52 Cu.Ft.: 0.82				
INDIVIDUAL CARTON: H: 17.13 W: 8.86 D: 3.86 Wt: 2.5				
OUT OF CARTON: HxWxD Spatula: 16.4 x 4.0 x 4.3 Scraper: 12.4 x 5.5 x 1.1 Bottle: 7.7 x 2.8 x 2.8				













3400021	8-PC. GRIDDLE CLEANING KIT	\$49.99	\$54.99	
		<ul style="list-style-type: none"> • Includes: 1 detail scraper, 3 scour pads, 2 cleaning stones, 2 easy grip handles • Detail scraper's beveled design effectively removes debris, including corners • Easy grip handles are lightweight and clip on securely for effortless cleaning • Durable scouring pad and cleaning stone can be used on warm and cool surfaces • Handles and scraper are dishwasher safe for quick cleanup 		
MASTER CARTON: 2 H: 12.01 W: 10.83 D: 10.43 Wt: 6.4 Cu.Ft.: 0.77				
INDIVIDUAL CARTON: H: 11.42 W: 10.04 D: 4.61 Wt: 2.75				
OUT OF CARTON: H: W: D:				

3400022	6-PC. GRIDDLE CLEANING KIT	\$39.99	\$44.99	
		<ul style="list-style-type: none"> • Includes: 2 scour pads, 2 cleaning stones, 2 easy grip handles • Durable scouring pad and cleaning stone can be used on warm and cool surfaces • Easy grip handles are lightweight and clip on securely for effortless cleaning • Handles are dishwasher safe for quick cleanup 		
MASTER CARTON: 2 H: 11.81 W: 10.83 D: 10.43 Wt: 5.75 Cu.Ft.: 0.77				
INDIVIDUAL CARTON: H: 11.1 W: 10.04 D: 4.61 Wt: 2.6				
OUT OF CARTON: H: W: D:				

3400023	GRIDDLE SCOUR PAD REPLACEMENT PACK	\$24.99	\$29.99	
		<ul style="list-style-type: none"> • Includes 6 Griddle Scour Pads • Removes debris from griddle cooking surface • Cleans on warm or cool surfaces • Durable pads don't shed during use 		
MASTER CARTON: 6 H: 6.57 W: 13.86 D: 13.58 Wt: 5.4 Cu.Ft.: 0.72				
INDIVIDUAL CARTON: H: 5.93 W: 6.3 D: 4.17 Wt: 0.8				
OUT OF CARTON: H: 1.1 W: 3.9 D: 5.4				

3400024	GRIDDLE CLEANING STONE REPLACEMENT PACK	\$14.99	\$17.99	
		<ul style="list-style-type: none"> • Buffs off stubborn food residue, grease and surface rust • Cleans efficiently on cool and warm surfaces • Stone can be rinsed with water and used more than once • Includes 3 Griddle Cleaning Stones 		
MASTER CARTON: 6 H: 6.65 W: 11.81 D: 10.63 Wt: 12.1 Cu.Ft.: 0.48				
INDIVIDUAL CARTON: H: 6.1 W: 4.84 D: 3.46 Wt: 2				
OUT OF CARTON: H: 1.9 W: 3.2 D: 4.6				

COOKING: GRIDDLE TOOLS













<p>3400061 SMASHED BURGER PRESS</p> 	<ul style="list-style-type: none"> Includes: Smashed Burger Press, patty paper, wide spatula, and two seasoning shakers Smashed Burger Press releases easily and helps create edge-to-edge crust Wide spatula effortlessly slides under burgers and can be used to smash with its reinforced neck Seasoning shakers are easy to fill and have a cap to prevent spills For a clean release, place custom-sized patty paper between the burger and the Smashed Burger Press 	<p>\$69.99 \$79.99</p> <p>MASTER CARTON: 4 H: 16.69 W: 14.65 D: 7.72 Wt: 8.5 Cu.Ft.: 1.69</p> <p>INDIVIDUAL CARTON: H: 16.14 W: 9.17 D: 3.35 Wt: 4.2</p> <p>OUT OF CARTON: H: W: D:</p>	 0 77924 98957 5
<p>6572 GRIDDLE SMASHED BURGER PRESS</p> 	<ul style="list-style-type: none"> Specially designed for griddled smashed burgers Made from durable stainless steel Dishwasher safe for easy cleanup Non-slip grip to easily move from burger to burger Smooth surface for better release from your burger and an easier clean 	<p>\$29.99 \$34.99</p> <p>MASTER CARTON: 24 H: 16.34 W: 22.64 D: 13.39 Wt: 39.4 Cu.Ft.: 2.87</p> <p>INDIVIDUAL CARTON: H: 7.72 W: 7.17 D: 3.07 Wt: 1.54</p> <p>OUT OF CARTON: H: 2.9 W: 7.2 D: 7</p>	 0 77924 20113 4
<p>3400074 PORTABLE GRIDDLE TOOL SET</p> 	<ul style="list-style-type: none"> Compact spatula, tongs, and scraper transport easily Made from durable stainless steel Tools clean easily, dishwasher safe Fits comfortably in the Portable Tools Backpack (sold separately) 	<p>\$39.99 \$44.99</p> <p>MASTER CARTON: 4 H: 14.96 W: 10.67 D: 8.19 Wt: 4.4 Cu.Ft.:</p> <p>INDIVIDUAL CARTON: H: 15.88 W: 7.48 D: 2.36 Wt: 2</p> <p>OUT OF CARTON: H: W: D:</p>	 0 77924 99019 9
<p>3400076 GRIDDLE DEEP CLEANER</p> 	<ul style="list-style-type: none"> Loosens stubborn grease and grime for easy cleaning Ideal for your griddle's cooking surface, side tables and control knobs Non-flammable, non-corrosive, and phosphate free Griddle cooking surface will need to be re-seasoned after use 	<p>\$14.99 \$17.99</p> <p>MASTER CARTON: 6 H: 11.5 W: 6.25 D: 8.25 Wt: 8 Cu.Ft.: 0.34</p> <p>INDIVIDUAL CARTON: H: 10.85 W: 3.75 D: 2 Wt: 1.30</p> <p>OUT OF CARTON: H: 10.85 W: 3.75 D: 2</p>	 0 77924 99081 6
<p>9349 GRIDDLE SEASONING WAX</p> 	<ul style="list-style-type: none"> Coating created helps protect your griddle Develops layer of seasoning so food lifts easily Made of grapeseed oil, canola oil and beeswax (from U.S. bee farms) Antibacterial beeswax bonds oils for a solid layer of seasoning, smoother application and no sticky residue 	<p>\$24.99 \$29.99</p> <p>MASTER CARTON: 12 H: 4.25 W: 7 D: 9.5 Wt: 4.2 Cu.Ft.: 0.1</p> <p>INDIVIDUAL CARTON: H: 1.8 W: 2.8 D: 2.8 Wt: 0.34</p> <p>OUT OF CARTON: H: 2 W: 3 D: 3</p>	 0 77924 20112 7
<p>3400215 GRIDDLE MID-SHELF MAT</p> 	<ul style="list-style-type: none"> Protects your middle shelf when storing tools Made from durable, heat-resistant silicone Cleans easily by rinsing, also dishwasher safe Compatible with Slate™ 30" or 36" Rust-Resistant Griddle Easily rolls up for storage 	<p>\$49.99 \$54.99</p> <p>MASTER CARTON: 6 H: 6.7 W: 16.85 D: 9.25 Wt: 28.50 Cu.Ft.: 0.6</p> <p>INDIVIDUAL CARTON: H: 2.8 W: 2.8 D: 16 Wt: 2.1</p> <p>OUT OF CARTON: H: 0.75 W: 30 D: 16</p>	 0 77924 99684 9

ACCESSORIES







MAP

MSRP

COOKING: GRIDDLE TOOLS

<p>3400073 GRIDDLE TACO RACK</p> 	<ul style="list-style-type: none"> • Holds up to six tacos • Silicone handles for comfortable grip • Dishwasher safe for easy cleanup • Durable stainless steel construction • Two convenient sauce cups • Do not leave on hot surfaces - handles may get hot • If used on heated cook surface, place on heat-resistant surface for serving 	<p>\$29.99 \$34.99</p> <p>MASTER CARTON: 4 H: 6.77 W: 18.58 D: 5.59 Wt: 9.96 Cu.Ft.: 0.5</p> <p>INDIVIDUAL CARTON: H: 4.38 W: 18.1 D: 4.72 Wt: 1.6</p> <p>OUT OF CARTON: H: 4.38 W: 18.1 D: 4.72</p>	 <p>0 77924 99018 2</p>
<p>3400123 GRIDDLE TRAVEL CASE</p> 	<ul style="list-style-type: none"> • Sturdy handles to carry your griddle securely • Large cover zips open to easily pack or remove your griddle • Adjustable strap keeps griddle in place while traveling • Padded bottom protects your griddle while in motion • Lightweight design for easy transportation • Weather-resistant fabric helps shield your griddle from the elements 	<p>\$49.99 \$54.99</p> <p>MASTER CARTON: 4 H: 13.8 W: 19.1 D: 9.05 Wt: 6 Cu.Ft.: 1.11</p> <p>INDIVIDUAL CARTON: H: 4 W: 18.5 D: 13 Wt: 1.5</p> <p>OUT OF CARTON: H: 10.4 W: 35.2 D: 23.2</p>	 <p>0 77924 99205 6</p>
<p>6778 GRIDDLE BREAKFAST SET</p> 	<ul style="list-style-type: none"> • Egg Rings (2) are stackable and easy to store • Batter Dispenser (1) holds up to 27 oz. of batter, marinades and more • Dishwasher safe and BPA Free 	<p>\$29.99 \$34.99</p> <p>MASTER CARTON: 2 H: 12.01 W: 9.06 D: 4.73 Wt: 1.61 Cu.Ft.: 0.3</p> <p>INDIVIDUAL CARTON: H: 11.25 W: 4.38 D: 4.38 Wt: 0.6</p> <p>OUT OF CARTON: HxWxD Egg Rings: 1.2 x W x 4.1 Batter Dispenser: 10.5 x W x 2.8</p>	 <p>0 77924 19355 2</p>
<p>6779 GRIDDLE SPATULA</p> 	<ul style="list-style-type: none"> • Beveled edge easily slides under food from any direction. • No-slip handle is elevated to avoid resting on messy surfaces. • Dishwasher safe. 	<p>\$21.99 \$24.99</p> <p>MASTER CARTON: 6 H: 17.33 W: 4.73 D: 13 Wt: 6.95 Cu.Ft.: 0.62</p> <p>INDIVIDUAL CARTON: H: 16.54 W: 3.94 D: 1.97 Wt: 0.07</p> <p>OUT OF CARTON: H: 16.4 W: 4.0 D: 4.3</p>	 <p>0 77924 19356 9</p>
<p>6780 GRIDDLE FLEXIBLE SPATULA</p> 	<ul style="list-style-type: none"> • Beveled edge easily slides under delicate foods. • Slotted for no-stick release. • Angled to easily fold, flip and turn. • Dishwasher safe. 	<p>\$18.99 \$21.99</p> <p>MASTER CARTON: 6 H: 16.15 W: 4.33 D: 11.42 Wt: 3.31 Cu.Ft.: 0.46</p> <p>INDIVIDUAL CARTON: H: 15.36 W: 3.74 D: 1.78 Wt: 0.5</p> <p>OUT OF CARTON: H: 15.5 W: 3.8 D: 3.2</p>	 <p>0 77924 19357 6</p>
<p>6781 GRIDDLE SCRAPER</p> 	<ul style="list-style-type: none"> • Scrapes away grease and grime. • No-slip, easy grip handle. • Dishwasher safe. 	<p>\$18.99 \$21.99</p> <p>MASTER CARTON: 6 H: 13.39 W: 6.3 D: 10.24 Wt: 4.85 Cu.Ft.: 0.5</p> <p>INDIVIDUAL CARTON: H: 12.5 W: 5.71 D: 1.58 Wt: 0.9</p> <p>OUT OF CARTON: H: 12.4 W: 5.5 D: 1.1</p>	 <p>0 77924 19358 3</p>

COOKING: GRIDDLE TOOLS



6782	GRIDDLE SQUEEZE BOTTLES	\$12.99 \$15.99	 0 77924 19359 0
	<ul style="list-style-type: none"> • 2 easy-to-dispense, 16 oz. bottles with twist-close cap to prevent spills. • Dishwasher safe and BPA free. 	MASTER CARTON: 4 H: 8.4 W: 6.69 D: 13.11 Wt: 6.66 Cu.Ft.: 0.42	
		INDIVIDUAL CARTON: H: 8.27 W: 6.73 D: 12.99 Wt: 1.66	
		OUT OF CARTON: H: 7.7 W: 2.8 D: 2.8	
		6783	GRIDDLE BASTING DOME
	<ul style="list-style-type: none"> • Melts cheese and steams veggies, rice and more • Covers up to 4 standard 4" burgers at once • T-shaped handle for ease of use • Dishwasher safe 	MASTER CARTON: 4 H: 11.62 W: 12.41 D: 18.9 Wt: 7.94 Cu.Ft.: 1.58	
		INDIVIDUAL CARTON: H: 10.44 W: 10.44 D: 3.55 Wt: 1.13	
		OUT OF CARTON: H: 10.2 W: 10.2 D: 4.9	
		6784	GRIDDLE KEEP WARM RACK
	<ul style="list-style-type: none"> • Highly durable construction • Raised back edge to lift food with ease • Collapsible legs for easy storage 	MASTER CARTON: 6 H: 8.67 W: 17.33 D: 9.45 Wt: 9.92 Cu.Ft.: 0.82	
		INDIVIDUAL CARTON: H: 7.48 W: 15.75 D: 1.19 Wt: 1.5	
		OUT OF CARTON: H: 2.6 W: 16.5 D: 7.8	
		6785	GRIDDLE PRESS
	<ul style="list-style-type: none"> • Presses burgers and paninis, and up to 4 strips of bacon without curling. • Textured design keeps food from sticking. 	MASTER CARTON: 4 H: 4.33 W: 10.63 D: 18.7 Wt: 19.4 Cu.Ft.: 0.5	
		INDIVIDUAL CARTON: H: 2.92 W: 8.86 D: 6.0 Wt: 3.75	
		OUT OF CARTON: H: 2.9 W: 9.0 D: 6.0	
		6786	CROSSBACK APRON
	<ul style="list-style-type: none"> • 7 easy-access pockets, durable clothing protection and crossback straps for a comfortable fit. 	MASTER CARTON: 6 H: 7.48 W: 8.67 D: 12.21 Wt: 6.62 Cu.Ft.: 0.46	
		INDIVIDUAL CARTON: H: 6.79 W: 4.06 D: 3.86 Wt: 1.02	
		OUT OF CARTON: H: 35.5 W: 26.5 D: 0.1	



ACCESSORIES



MAP

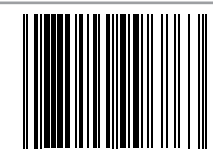

MSRP

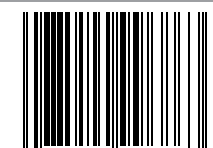

WEBER WORKS: ACCESSORIES NEW

3400131	WEBER WORKS CUTTING BOARD & BASIN	\$39.99	\$44.99	 0 77924 99300 8
 <h3 style="margin: 0;">Details coming soon</h3>	MASTER CARTON: 2			
	H: 4.8 W: 14.7 D: 9.8 Wt: 8.8 Cu.Ft.: 9.5			
	INDIVIDUAL CARTON:			
	H: 4.5 W: 14.4 D: 9.5 Wt:			
OUT OF CARTON:				
H: 4.5 W: 14.4 D: 9.5				

3400220	WEBER WORKS SERVING KIT	\$59.99	\$69.99	 0 77924 99686 3
 <h3 style="margin: 0;">Details coming soon</h3>	MASTER CARTON: 3			
	H: 13.8 W: 10.8 D: 15.9 Wt: 14.1 Cu.Ft.: 1.4			
	INDIVIDUAL CARTON:			
	H: 15 W: 9.8 D: 4.1 Wt:			
OUT OF CARTON:				
H: 3.1 W: 14.4 D: 9.5				

3400260	WEBER WORKS PREP CONTAINERS	\$44.99	\$49.99	 0 77924 99686 3
 <h3 style="margin: 0;">Details coming soon</h3>	MASTER CARTON: 4			
	H: 9.9 W: 16.7 D: 15 Wt: 6.6 Cu.Ft.: 1.4			
	INDIVIDUAL CARTON:			
	H: 8.8 W: 6.9 D: 6.1 Wt:			
OUT OF CARTON:				
H: 2.9 W: 8.2 D: 6.6				

3400518	WEBER WORKS FLEX LIGHT	\$39.99	\$44.99	 0 77924 01658 5
 <h3 style="margin: 0;">Details coming soon</h3>	MASTER CARTON: 4			
	H: 9 W: 8.5 D: 10.6 Wt: 9.3 Cu.Ft.: 0.5			
	INDIVIDUAL CARTON:			
	H: 7.9 W: 7.5 D: 2.4 Wt:			
OUT OF CARTON:				
H: 2.6 W: 27.3 D: 2.3				

3400519	WEBER WORKS TOOL HOOKS	\$9.99	\$10.99	 0 77924 88916 5
 <h3 style="margin: 0;">Details coming soon</h3>	MASTER CARTON: 6			
	H: 8 W: 5.9 D: 4.6 Wt: 2 Cu.Ft.: 0.1			
	INDIVIDUAL CARTON:			
	H: 6.3 W: 2.8 D: 1.5 Wt:			
OUT OF CARTON:				
H: 2.1 W: 0.9 D: 1.8				

3400665	WEBER WORKS PELLET SIDE TABLE	\$99.99	\$109.99	 0 77924 88970 7
<p style="margin: 0;">Image coming soon</p> <h3 style="margin: 0;">Details coming soon</h3>	MASTER CARTON: 1			
	H: 4 W: 14 D: 18 Wt: 5 Cu.Ft.: 0.6			
	INDIVIDUAL CARTON:			
	H: 4 W: 14 D: 18 Wt:			
OUT OF CARTON:				
H: 3.2 W: 17.1 D: 13.3				

WEBER WORKS: ACCESSORIES NEW











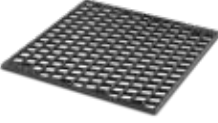

3400128	WEBER WORKS CADDY WITH TRAY LID	 <ul style="list-style-type: none"> • Easily transport items from the kitchen to the grill • Caddy and Tray Lid fit together into Weber Works™ side table • Collapsible handle allows Tray Lid to secure on top for storage • Weber Works™ System comes on Slate™ Griddles and Expandable Stand • Explore all Weber Works™ Prep, Cook, and Store System accessories 	<table border="1"> <tr> <td></td> <td style="text-align: right;">\$39.99</td> <td style="text-align: right;">\$44.99</td> </tr> <tr> <td colspan="3">MASTER CARTON: 2</td> </tr> <tr> <td>H: 6</td> <td>W: 15</td> <td>D: 11</td> </tr> <tr> <td>Wt: 2.75</td> <td colspan="2">Cu.Ft.: 0.57</td> </tr> <tr> <td colspan="3">INDIVIDUAL CARTON:</td> </tr> <tr> <td>H: 6.2</td> <td>W: 14.65</td> <td>D: 9.55</td> </tr> <tr> <td>Wt: 2.7</td> <td colspan="2"></td> </tr> <tr> <td colspan="3">OUT OF CARTON:</td> </tr> <tr> <td>H: 5.5</td> <td>W: 14.5</td> <td>D: 9.5</td> </tr> </table>		\$39.99	\$44.99	MASTER CARTON: 2			H: 6	W: 15	D: 11	Wt: 2.75	Cu.Ft.: 0.57		INDIVIDUAL CARTON:			H: 6.2	W: 14.65	D: 9.55	Wt: 2.7			OUT OF CARTON:			H: 5.5	W: 14.5	D: 9.5	 <p>0 77924 99302 2</p>
	\$39.99	\$44.99																													
MASTER CARTON: 2																															
H: 6	W: 15	D: 11																													
Wt: 2.75	Cu.Ft.: 0.57																														
INDIVIDUAL CARTON:																															
H: 6.2	W: 14.65	D: 9.55																													
Wt: 2.7																															
OUT OF CARTON:																															
H: 5.5	W: 14.5	D: 9.5																													
3400107	WEBER WORKS OUTDOOR STORAGE BIN	 <ul style="list-style-type: none"> • Weather-resistant lid seals tightly to protect contents inside • Drops into Weber Works™ side table to keep gear handy • Slides onto Weber Works™ brackets on open carts for easy storage • Hinged lid opens easily for quick access • Weber Works™ System comes on Slate™ Griddles and Expandable Stand 	<table border="1"> <tr> <td></td> <td style="text-align: right;">\$39.99</td> <td style="text-align: right;">\$44.99</td> </tr> <tr> <td colspan="3">MASTER CARTON: 2</td> </tr> <tr> <td>H: 13.63</td> <td>W: 19.6</td> <td>D: 14.85</td> </tr> <tr> <td>Wt: 3.25</td> <td colspan="2">Cu.Ft.: 2.29</td> </tr> <tr> <td colspan="3">INDIVIDUAL CARTON:</td> </tr> <tr> <td>H: 7.05</td> <td>W: 14.9</td> <td>D: 19.55</td> </tr> <tr> <td>Wt: 1</td> <td colspan="2"></td> </tr> <tr> <td colspan="3">OUT OF CARTON:</td> </tr> <tr> <td>H: 6.5</td> <td>W: 14.5</td> <td>D: 19</td> </tr> </table>		\$39.99	\$44.99	MASTER CARTON: 2			H: 13.63	W: 19.6	D: 14.85	Wt: 3.25	Cu.Ft.: 2.29		INDIVIDUAL CARTON:			H: 7.05	W: 14.9	D: 19.55	Wt: 1			OUT OF CARTON:			H: 6.5	W: 14.5	D: 19	 <p>0 77924 99271 1</p>
	\$39.99	\$44.99																													
MASTER CARTON: 2																															
H: 13.63	W: 19.6	D: 14.85																													
Wt: 3.25	Cu.Ft.: 2.29																														
INDIVIDUAL CARTON:																															
H: 7.05	W: 14.9	D: 19.55																													
Wt: 1																															
OUT OF CARTON:																															
H: 6.5	W: 14.5	D: 19																													
3400104	WEBER WORKS BOTTLE HOLDER	 <ul style="list-style-type: none"> • Easily snaps onto the Weber Works™ rail to keep beverages handy • Holds a variety of bottles, cans, mugs, and tumblers • Keeps side table clear for prepping and serving • Dishwasher safe 	<table border="1"> <tr> <td></td> <td style="text-align: right;">\$12.99</td> <td style="text-align: right;">\$15.99</td> </tr> <tr> <td colspan="3">MASTER CARTON: 4</td> </tr> <tr> <td>H: 12.63</td> <td>W: 5.1</td> <td>D: 8.85</td> </tr> <tr> <td>Wt: 5.5</td> <td colspan="2">Cu.Ft.: 0.33</td> </tr> <tr> <td colspan="3">INDIVIDUAL CARTON:</td> </tr> <tr> <td>H: 5</td> <td>W: 3.9</td> <td>D: 6</td> </tr> <tr> <td>Wt: 1.25</td> <td colspan="2"></td> </tr> <tr> <td colspan="3">OUT OF CARTON:</td> </tr> <tr> <td>H: 4.62</td> <td>W: 4.05</td> <td>D: 5.78</td> </tr> </table>		\$12.99	\$15.99	MASTER CARTON: 4			H: 12.63	W: 5.1	D: 8.85	Wt: 5.5	Cu.Ft.: 0.33		INDIVIDUAL CARTON:			H: 5	W: 3.9	D: 6	Wt: 1.25			OUT OF CARTON:			H: 4.62	W: 4.05	D: 5.78	 <p>0 77924 99268 1</p>
	\$12.99	\$15.99																													
MASTER CARTON: 4																															
H: 12.63	W: 5.1	D: 8.85																													
Wt: 5.5	Cu.Ft.: 0.33																														
INDIVIDUAL CARTON:																															
H: 5	W: 3.9	D: 6																													
Wt: 1.25																															
OUT OF CARTON:																															
H: 4.62	W: 4.05	D: 5.78																													
3400105	WEBER WORKS CONDIMENT HOLDER	 <ul style="list-style-type: none"> • Easily snaps onto the Weber Works™ rail to keep items in reach • Keeps side table clear for prepping and serving • Drainage holes prevent sauces from pooling in bottom • Dishwasher safe 	<table border="1"> <tr> <td></td> <td style="text-align: right;">\$24.99</td> <td style="text-align: right;">\$29.99</td> </tr> <tr> <td colspan="3">MASTER CARTON: 2</td> </tr> <tr> <td>H: 9</td> <td>W: 9.85</td> <td>D: 12.6</td> </tr> <tr> <td>Wt: 2.5</td> <td colspan="2">Cu.Ft.: 0.65</td> </tr> <tr> <td colspan="3">INDIVIDUAL CARTON:</td> </tr> <tr> <td>H: 4.75</td> <td>W: 12.25</td> <td>D: 8.35</td> </tr> <tr> <td>Wt: 1.75</td> <td colspan="2"></td> </tr> <tr> <td colspan="3">OUT OF CARTON:</td> </tr> <tr> <td>H: 4.62</td> <td>W: 12.05</td> <td>D: 8.06</td> </tr> </table>		\$24.99	\$29.99	MASTER CARTON: 2			H: 9	W: 9.85	D: 12.6	Wt: 2.5	Cu.Ft.: 0.65		INDIVIDUAL CARTON:			H: 4.75	W: 12.25	D: 8.35	Wt: 1.75			OUT OF CARTON:			H: 4.62	W: 12.05	D: 8.06	 <p>0 77924 99269 8</p>
	\$24.99	\$29.99																													
MASTER CARTON: 2																															
H: 9	W: 9.85	D: 12.6																													
Wt: 2.5	Cu.Ft.: 0.65																														
INDIVIDUAL CARTON:																															
H: 4.75	W: 12.25	D: 8.35																													
Wt: 1.75																															
OUT OF CARTON:																															
H: 4.62	W: 12.05	D: 8.06																													
3400106	WEBER WORKS ORGANIZER KIT	 <ul style="list-style-type: none"> • Includes Paper Towel Holder, Garbage Bag Holder, 4 Tool Hooks • Pieces snap onto the Weber Works™ rail to keep items within reach • Keeps side table clear for prepping and serving • Set of 4 Tools Hooks to hang extra spatulas, tongs, and more 	<table border="1"> <tr> <td></td> <td style="text-align: right;">\$49.99</td> <td style="text-align: right;">\$54.99</td> </tr> <tr> <td colspan="3">MASTER CARTON: 4</td> </tr> <tr> <td>H: 13.38</td> <td>W: 12.35</td> <td>D: 21.85</td> </tr> <tr> <td>Wt: 16.75</td> <td colspan="2">Cu.Ft.: 2.09</td> </tr> <tr> <td colspan="3">INDIVIDUAL CARTON:</td> </tr> <tr> <td>H: 12</td> <td>W: 9.80</td> <td>D: 2.35</td> </tr> <tr> <td>Wt: 8</td> <td colspan="2"></td> </tr> <tr> <td colspan="3">OUT OF CARTON:</td> </tr> <tr> <td>H: NA</td> <td>W: NA</td> <td>D: NA</td> </tr> </table>		\$49.99	\$54.99	MASTER CARTON: 4			H: 13.38	W: 12.35	D: 21.85	Wt: 16.75	Cu.Ft.: 2.09		INDIVIDUAL CARTON:			H: 12	W: 9.80	D: 2.35	Wt: 8			OUT OF CARTON:			H: NA	W: NA	D: NA	 <p>0 77924 99270 4</p>
	\$49.99	\$54.99																													
MASTER CARTON: 4																															
H: 13.38	W: 12.35	D: 21.85																													
Wt: 16.75	Cu.Ft.: 2.09																														
INDIVIDUAL CARTON:																															
H: 12	W: 9.80	D: 2.35																													
Wt: 8																															
OUT OF CARTON:																															
H: NA	W: NA	D: NA																													

ACCESSORIES



MAP

MSRP



WEBER CRAFTED: GRILLWARE (WEBER CRAFTED frame and grates required.)



<p>7670 WEBER CRAFTED DUAL SIDED SEAR GRATE</p>  <ul style="list-style-type: none"> Creates restaurant-quality sear marks Designed to grill meat on one side, delicate food on the reverse Porcelain enamel helps make flipping and lifting food easy Extra large surface for searing multiple steaks at once 	<p>MASTER CARTON: 1 H: 1.9 W: 18.7 D: 20.1 Wt: 11.4 Cu.Ft.: 0.4</p> <p>INDIVIDUAL CARTON: H: 1.5 W: 18.3 D: 19.2 Wt: 10.3</p> <p>OUT OF CARTON: H: 0.3 W: 16.0 D: 16.3</p>	<p>\$99.99 \$109.99</p> 
<p>7671 WEBER CRAFTED GLAZED BAKING STONE</p>  <ul style="list-style-type: none"> Designed to create perfectly crispy pizza crust Glazed finish helps keep food from sticking and cleanup easy Stone designed to efficiently absorb, retain, and distribute heat 	<p>MASTER CARTON: 1 H: 3.7 W: 21.5 D: 20.9 Wt: 11.2 Cu.Ft.: 1.0</p> <p>INDIVIDUAL CARTON: H: 3.0 W: 20.1 D: 19.9 Wt: 10.2</p> <p>OUT OF CARTON: H: 0.5 W: 16.0 D: 16.3</p>	<p>\$99.99 \$109.99</p> 
<p>7672 WEBER CRAFTED FLAT TOP</p>  <ul style="list-style-type: none"> Make pancakes & eggs to fajitas on the large, flat surface Heats quickly and evenly with warp-resistant carbon steel Rimmed edge helps keeps oil, and seasonings in place 	<p>MASTER CARTON: 1 H: 2.8 W: 19.8 D: 20.3 Wt: 16.1 Cu.Ft.: 0.7</p> <p>INDIVIDUAL CARTON: H: 2.3 W: 19.3 D: 19.8 Wt: 15.3</p> <p>OUT OF CARTON: H: 1.0 W: 15.8 D: 16.3</p>	<p>\$99.99 \$109.99</p> 
<p>7673 WEBER CRAFTED ROASTING BASKET</p>  <ul style="list-style-type: none"> Roast small, delicate food without it falling through the grate WEBER CRAFTED frame and grates required Helps with heat circulation for perfectly roasted veggies Dishwasher safe, stainless-steel construction 	<p>MASTER CARTON: 1 H: 2.7 W: 17.6 D: 17.6 Wt: 4.5 Cu.Ft.: 0.5</p> <p>INDIVIDUAL CARTON: H: 2.0 W: 16.3 D: 17.2 Wt: 3.1</p> <p>OUT OF CARTON: H: 2.0 W: 17.2 D: 16.3</p>	<p>\$99.99 \$109.99</p> 
<p>7675 WEBER CRAFTED ROTISSERIE SKEWERS</p>  <ul style="list-style-type: none"> 16-in. skewers slowly rotate for even cooking Simply slides onto the rotisserie spit Dishwasher safe, stainless-steel construction Grill rotisserie unit required for use 	<p>MASTER CARTON: 2 H: 6.5 W: 6.1 D: 18.3 Wt: 5.2 Cu.Ft.: 0.4</p> <p>INDIVIDUAL CARTON: H: 2.8 W: 6.0 D: 17.2 Wt: 2.3</p> <p>OUT OF CARTON: H: 5.3 W: 17.7 D: 6.6</p>	<p>\$72.99 \$82.99</p> 
<p>7676 WEBER CRAFTED CRISPING BASKET</p>  <ul style="list-style-type: none"> Circulates heat evenly for quick, crispy results. Quickly connects to your rotisserie spit. Crisp a variety of food all at once with the removable divider (included). 	<p>MASTER CARTON: 2 H: 10.25 W: 18.3 D: 21.5 Wt: 10.6 Cu.Ft.: 2.3</p> <p>INDIVIDUAL CARTON: H: 9.0 W: 9.85 D: 20.75 Wt: 5.2</p> <p>OUT OF CARTON: H: 7.55 W: 19.11 D: 7.91</p>	<p>\$89.49 \$99.49</p> 



WEBER CRAFTED: GRILLWARE (WEBER CRAFTED frame and grates required.)



<p>7606</p> 	<p>WEBER CRAFTED WOK & STEAMER</p> <ul style="list-style-type: none"> • Porcelain-enameled cast iron retains heat for fast, even cooking. • Steam fresh veggies, tender dumplings, and delicate seafood right at the grill with the Stainless Steel Steamer Basket. • Large, 6 Quart (5.7 Liter) capacity. 	<p style="text-align: right;">\$149.99 \$159.99</p> <p>MASTER CARTON: 1 H: 8.0 W: 18.0 D: 17.5 Wt: 18.0 Cu.Ft.: 1.45</p> <p>INDIVIDUAL CARTON: H: 7.0 W: 17.5 D: 17.0 Wt: 16.6</p> <p>OUT OF CARTON: H: 4.5 W: 15.4 D: 19.4</p>	 <p>0 77924 17427 8</p>
--	--	--	--

WEBER CRAFTED: FRAME KITS

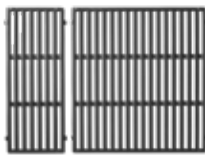
<p>7677</p> 	<p>WEBER CRAFTED FRAME KIT</p> <ul style="list-style-type: none"> • Frame Kit is required to use WEBER CRAFTED grillware • Sits under the right-side cooking grate when not in use • Fits GENESIS (2022), GENESIS II 300 and 400 series gas grills 	<p style="text-align: right;">\$49.99</p> <p>MASTER CARTON: 4 H: 10.0 W: 19 D: 21.1 Wt: 31.9 Cu.Ft.: 2.3</p> <p>INDIVIDUAL CARTON: H: 2.1 W: 18.3 D: 20.2 Wt: 7.1</p> <p>OUT OF CARTON: H: 1.0 W: 16.8 D: 18.9</p>	 <p>0 77924 17425 4</p>
---	---	--	---

<p>7678</p> 	<p>WEBER CRAFTED FRAME KIT</p> <ul style="list-style-type: none"> • Frame Kit is required to use WEBER CRAFTED grillware • Sits under the right-side cooking grate when not in use • Fits SPIRIT 200 and 300 series, SPIRIT II 200 and 300 series, SEARWOOD 600 and XL 600, and SMOKEFIRE EX6 wood pellet grills 	<p style="text-align: right;">\$49.99</p> <p>MASTER CARTON: 4 H: 10.0 W: 19 D: 19.7 Wt: 25.4 Cu.Ft.: 2.2</p> <p>INDIVIDUAL CARTON: H: 2.1 W: 18.3 D: 18.9 Wt: 5.6</p> <p>OUT OF CARTON: H: 1.0 W: 16.8 D: 17.5</p>	 <p>0 77924 17739 2</p>
--	---	--	--

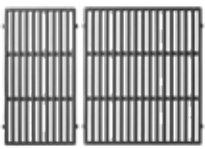
<p>7856</p> 	<p>WEBER CRAFTED PECOL COOKING GRATES</p> <ul style="list-style-type: none"> • Fits SPIRIT 300 series 2016+, SEARWOOD 600 and SMOKEFIRE EX4 grills • Required to use most WEBER CRAFTED grillware • Superior heat retention and distribution • Set of 2 	<p style="text-align: right;">\$117.59 \$127.59</p> <p>MASTER CARTON: 1 H: 3.1 W: 19.9 D: 22.9 Wt: 15.4 Cu.Ft.: 0.8</p> <p>INDIVIDUAL CARTON: H: 2.3 W: 19.0 D: 20.4 Wt: 12.9</p> <p>OUT OF CARTON: H: 0.4 W: 23.6 D: 17.5</p>	 <p>0 77924 18078 1</p>
--	--	---	--









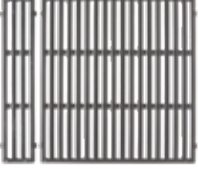

<p>7853</p> 	<p>WEBER CRAFTED PECOL COOKING GRATE</p> <ul style="list-style-type: none"> • Fits GENESIS 300 series grills 2016+ • Required to use most WEBER CRAFTED grillware • Superior heat retention and distribution • Set of 2 	<p style="text-align: right;">\$145.99 \$155.99</p> <p>MASTER CARTON: 1 H: 3.1 W: 19.9 D: 23.7 Wt: 17.5 Cu.Ft.: 0.8</p> <p>INDIVIDUAL CARTON: H: 2.3 W: 19.0 D: 21.9 Wt: 15.0</p> <p>OUT OF CARTON: H: 0.4 W: 26.8 D: 18.9</p>	 <p>0 77924 18074 3</p>
--	--	---	--

ACCESSORIES





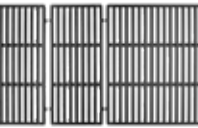





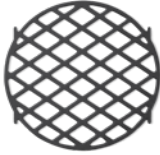

MAP

MSRP

WEBER CRAFTED: COOKING GRATES

<p>7849 WEBER CRAFTED PECCI COOKING GRATES</p> 	<ul style="list-style-type: none"> • Fits SPIRIT 200 series 2016+ • Required to use most WEBER CRAFTED grillware • Superior heat retention and distribution • Set of 2 	<p>\$104.99 \$114.99</p> <p>MASTER CARTON: 1 H: 3.1 W: 19.9 D: 22.9 Wt: 13.5 Cu.Ft.: 0.8</p> <p>INDIVIDUAL CARTON: H: 2.3 W: 19 D: 20.4 Wt: 10.9</p> <p>OUT OF CARTON: H: 0.4 W: 20.3 D: 17.5</p>	 <p>0 77924 18070 5</p>
<p>7859 WEBER CRAFTED STAINLESS STEEL COOKING GRATES</p> 	<ul style="list-style-type: none"> • Fits SEARWOOD XL 600 and SMOKEFIRE EX6 • Required to use most WEBER CRAFTED grillware • Highly durable 7mm stainless steel rods clean easily • Set of 3 	<p>\$185.99 \$205.99</p> <p>MASTER CARTON: 1 H: 24.33 W: 21.13 D: 3.96 Wt: 18.39 Cu.Ft.: 1.18</p> <p>INDIVIDUAL CARTON: H: 24.33 W: 21.13 D: 3.96 Wt: 18.39</p> <p>OUT OF CARTON: H: 0.55 W: 36 D: 17.3</p>	 <p>0 77924 18081 1</p>
<p>7860 WEBER CRAFTED STAINLESS STEEL COOKING GRATES</p> 	<ul style="list-style-type: none"> • Fits SPIRIT 300 series 2016+, SEARWOOD 600 and SMOKEFIRE EX4 • Required to use most WEBER CRAFTED grillware • Highly durable 7mm stainless steel rods clean easily • Set of 2 	<p>\$135.49 \$145.49</p> <p>MASTER CARTON: 1 H: 3.6 W: 22.1 D: 23.5 Wt: 12.6 Cu.Ft.: 1.1</p> <p>INDIVIDUAL CARTON: H: 2.3 W: 19.0 D: 21.9 Wt: 10.1</p> <p>OUT OF CARTON: H: 0.6 W: 23.5 D: 17.3</p>	 <p>0 77924 18082 8</p>
<p>7852 WEBER CRAFTED STAINLESS STEEL COOKING GRATE</p> 	<ul style="list-style-type: none"> • Fits GENESIS 300 series grills 2016+ • Required to use most WEBER CRAFTED grillware • Highly durable 7mm stainless steel rods clean easily • Set of 2 	<p>\$199.99 \$219.99</p> <p>MASTER CARTON: 1 H: 3.6 W: 22.1 D: 23.5 Wt: 12.6 Cu.Ft.: 1.1</p> <p>INDIVIDUAL CARTON: H: 2.3 W: 19.0 D: 21.9 Wt: 10.1</p> <p>OUT OF CARTON: H: 0.6 W: 26.6 D: 18.9</p>	 <p>0 77924 18073 6</p>
<p>7854 WEBER CRAFTED PECCI COOKING GRATES</p> 	<ul style="list-style-type: none"> • Fits GENESIS 400 series grills 2016+ • Required to use most WEBER CRAFTED grillware • Superior heat retention and distribution • Set of 3 	<p>\$179.99 \$199.99</p> <p>MASTER CARTON: 1 H: 4.1 W: 20.2 D: 25.9 Wt: 16.5 Cu.Ft.: 1.2</p> <p>INDIVIDUAL CARTON: H: 3.3 W: 19.3 D: 23.5 Wt: 14.0</p> <p>OUT OF CARTON: H: 0.4 W: 33.7 D: 18.9</p>	 <p>0 77924 18075 0</p>

GBS: INSERTS

<p>8834 SEAR GRATE</p>  <ul style="list-style-type: none"> • Porcelain-enameled, cast-iron sear grate prevents food from sticking and creates professional cross-hatch sear marks • Fits into the GOURMET BBQ SYSTEM cooking grate so that it stays in place while grilling 	<p>MASTER CARTON: 1 H: 2.63 W: 15.88 D: 15.3 Wt: 6.61 Cu.Ft.: 0.37</p> <p>INDIVIDUAL CARTON: H: 15.38 W: 15.88 D: 2.63 Wt: 6.61</p> <p>OUT OF CARTON: H: 11.9 W: 11.9 D: 0.5</p>	<p>\$59.49 \$69.49</p>	 <p>0 77924 00435 3</p>
<p>7421 GRIDDLE</p>  <ul style="list-style-type: none"> • Porcelain-enameled, cast-iron griddle provides exceptional heat retention and distribution ensuring evenly cooked food • Fits into the GOURMET BBQ SYSTEM cooking grate so that it stays in place while grilling 	<p>MASTER CARTON: 1 H: 2.63 W: 15.88 D: 15.38 Wt: 8.5 Cu.Ft.: 0.37</p> <p>INDIVIDUAL CARTON: H: 15.38 W: 15.88 D: 2.63 Wt: 8.5</p> <p>OUT OF CARTON: H: 15.2 W: 12.0 D: 2.0</p>	<p>\$59.49 \$69.49</p>	 <p>0 77924 00412 4</p>
<p>8836 PIZZA STONE</p>  <ul style="list-style-type: none"> • Cordierite stone absorbs moisture for light and crispy thin crust pizza • Carry rack makes transporting the pizza quick and easy • Fits into the GOURMET BBQ SYSTEM cooking grate so that it stays in place while grilling 	<p>MASTER CARTON: 1 H: 4.44 W: 15.88 D: 16.38 Wt: 6.5 Cu.Ft.: 0.66</p> <p>INDIVIDUAL CARTON: H: 16.38 W: 15.88 D: 4.44 Wt: 6.5</p> <p>OUT OF CARTON: H: 16.7 W: 13.2 D: 2.0</p>	<p>\$59.49 \$69.49</p>	 <p>0 77924 01328 7</p>
<p>8838 POULTRY ROASTER</p>  <ul style="list-style-type: none"> • Stainless steel • Roast a whole chicken using the liquid infusion cup • Remove cup and use basket alone for roasting vegetables or other small food items • Fits into the GOURMET BBQ SYSTEM cooking grate so that it stays in place while grilling 	<p>MASTER CARTON: 1 H: 3.69 W: 16.69 D: 17.0 Wt: 3.94 Cu.Ft.: 0.6</p> <p>INDIVIDUAL CARTON: H: 17.0 W: 16.69 D: 3.69 Wt: 3.94</p> <p>OUT OF CARTON: H: 15.9 W: 13 D: 3.6</p>	<p>\$72.99 \$82.99</p>	 <p>0 77924 01903 6</p>
<p>8859 DUTCH OVEN DUO</p>  <ul style="list-style-type: none"> • Multi-purpose cooker with a flat top lid that can be used as a griddle • Pieces can be used together or separately • Designed for compact storage • Easy to clean, porcelain-enameled, cast iron • Fits into the GOURMET BBQ SYSTEM cooking grate so that it stays in place while grilling 	<p>MASTER CARTON: 1 H: 6.7 W: 16.93 D: 17.72 Wt: 24.24 Cu.Ft.: 1.16</p> <p>INDIVIDUAL CARTON: H: 16.14 W: 16.54 D: 5.71 Wt: 22.47</p> <p>OUT OF CARTON: H: 4.83 W: 16.68 D: 13.19</p>	<p>\$167.99 \$187.99</p>	 <p>0 77924 16218 3</p>
<p>8860 GRILL & GRIDDLE STATION</p>  <ul style="list-style-type: none"> • Grills and sears various foods at the same time, maximizing space • Easy to clean, porcelain-enameled, cast iron • Stacks for compact storage • Fits into the GOURMET BBQ SYSTEM cooking grate so that it stays in place while grilling 	<p>MASTER CARTON: 1 H: 3.67 W: 11.03 D: 19.18 Wt: 14.6 Cu.Ft.: 0.44</p> <p>INDIVIDUAL CARTON: H: 10.25 W: 17.91 D: 3.15 Wt: 13.14</p> <p>OUT OF CARTON: H: 14.29 W: 14.1 D: 1.13</p>	<p>\$106.49 \$116.49</p>	 <p>0 77924 16219 0</p>

ACCESSORIES



MAP

MSRP

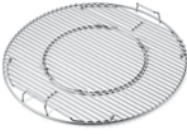

GBS: INSERTS

8835	COOKING GRATES	\$59.49	\$69.49		
	<ul style="list-style-type: none"> Hinged cooking grate for adding charcoal without removing the grate For use with GOURMET BBQ SYSTEM inserts Includes a 12 inch plated grate insert for traditional grilling Fits 22 inch WEBER charcoal grills 	MASTER CARTON: 5			
		H: 3.38 W: 22.88 D: 22.88 Wt: 42.75 Cu.Ft.: 1.02			
		INDIVIDUAL CARTON:			
		H: 21.5 W: 21.5 D: 1.75 Wt: 8.22			
		OUT OF CARTON:			
H: 21.5 W: 21.5 D: 1.5					

COOKING: BASKETS AND PANS

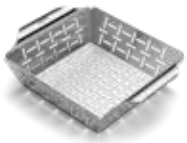





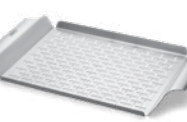





8829	GRILLING STONE	\$79.49	\$89.49		
	<ul style="list-style-type: none"> Stone distributes heat quickly and evenly Specially formulated glaze promotes crispy, restaurant-quality crusts Durable finish resists fading, cracking and chipping Versatile stone is ideal for baking pizzas, cookies, breads and pastries Integrated handles make the stone easy to lift and move Safe for use with gas, charcoal and electric grills 	MASTER CARTON: 1			
		H: 5.04 W: 19.06 D: 20.63 Wt: 10.0 Cu.Ft.: 1.14			
		INDIVIDUAL CARTON:			
		H: 19.06 W: 20.63 D: 5.04 Wt: 10.0			
		OUT OF CARTON:			
H: 18.5 W: 16.5 D: 1.0					

6481	DELUXE GRILLING BASKET	\$24.49	\$29.49		
	<ul style="list-style-type: none"> Ideal for vegetables and smaller pieces of meat Stainless steel Fits all WEBER charcoal, gas, and electric grills 	MASTER CARTON: 6			
		H: 3.82 W: 8.75 D: 10.57 Wt: 6.81 Cu.Ft.: 0.2			
		INDIVIDUAL CARTON:			
		H: 9.4 W: 7.5 D: 2.5 Wt: 1.02			
		OUT OF CARTON:			
H: 9.4 W: 7.5 D: 2.5					

6434	DELUXE GRILLING BASKET	\$30.99	\$35.99		
	<ul style="list-style-type: none"> Ideal for vegetables and smaller pieces of meat Stainless steel Fits all WEBER Q 300/3000 and larger gas grills, and 18 inch and larger charcoal grills 	MASTER CARTON: 4			
		H: 3.12 W: 13.0 D: 15.25 Wt: 9.15 Cu.Ft.: 0.35			
		INDIVIDUAL CARTON:			
		H: 13.8 W: 11.8 D: 2.5 Wt: 2.02			
		OUT OF CARTON:			
H: 13.8 W: 11.8 D: 2.5					

6435	DELUXE GRILLING PAN	\$30.99	\$35.99		
	<ul style="list-style-type: none"> Ideal for fish fillets or other delicate items that may fall between the grates Fits WEBER Q 300/3000 and larger gas grills, 22 inch and larger charcoal grills 	MASTER CARTON: 6			
		H: 2.88 W: 13.0 D: 18.63 Wt: 14.2 Cu.Ft.: 0.4			
		INDIVIDUAL CARTON:			
		H: 17.57 W: 11.88 D: 1.38 Wt: 2.14			
		OUT OF CARTON:			
H: 17.4 W: 11.8 D: 1.4					

COOKING: RACKS AND ROASTERS



6482 POULTRY ROASTER	 <ul style="list-style-type: none"> Makes transporting your roasted chicken to and from the grill quick and easy Center ring holds 12 oz. beverage to infuse poultry with flavor 	<p style="text-align: right;">\$24.49 \$29.49</p> MASTER CARTON: 6 H: 12.32 W: 7.57 D: 10.07 Wt: 6.41 Cu.Ft.: 0.54 INDIVIDUAL CARTON: H: 5.13 W: 9.32 D: 6.63 Wt: 0.88 OUT OF CARTON: H: 6.5 W: 9.3 D: 5.0	 0 77924 01196 2
6731 DELUXE POULTRY ROASTER	 <ul style="list-style-type: none"> Integrated cup holds juices, wine, beer and spices, infusing extra flavor into your poultry Easy to clean, non-stick coating 	<p style="text-align: right;">\$47.99 \$52.99</p> MASTER CARTON: 2 H: 9.13 W: 9.25 D: 10.38 Wt: 4.89 Cu.Ft.: 0.5 INDIVIDUAL CARTON: H: 8.38 W: 9.88 D: 4.38 Wt: 2.2 OUT OF CARTON: H: 15.5 W: 12.3 D: 3.5	 0 77924 01814 5
6469 PREMIUM BARBECUE RACK	 <ul style="list-style-type: none"> 2-in-1 design for roasting large cuts of meat or grilling up to five racks of ribs Fits WEBER Q 300/3000 and larger gas grills, and 22 inch and larger charcoal grills 	<p style="text-align: right;">\$29.49 \$34.49</p> MASTER CARTON: 4 H: 10.38 W: 11.32 D: 17.63 Wt: 8.31 Cu.Ft.: 1.2 INDIVIDUAL CARTON: H: 16.8 W: 10.6 D: 4.4 Wt: 2.1 OUT OF CARTON: H: 17.1 W: 10.5 D: 4.4	 0 77924 01083 5
6605 RIB RACK	 <ul style="list-style-type: none"> Holds up to five racks of ribs, increasing grill capacity Fits WEBER Q 200/2000 and larger gas grills, and 18 inch and larger charcoal grills 	<p style="text-align: right;">\$21.49 \$24.49</p> MASTER CARTON: 6 H: 11.2 W: 8.68 D: 13.81 Wt: 7.75 Cu.Ft.: 0.77 INDIVIDUAL CARTON: H: 13.22 W: 8.16 D: 3.5 Wt: 1.13 OUT OF CARTON: H: 13.2 W: 8.0 D: 3.5	 0 77924 02188 6
7647 EXPANSION GRILLING RACK	 <ul style="list-style-type: none"> Adds grilling space for cooking larger meals Stainless steel Fits SUMMIT charcoal grills, 26 inch WEBER charcoal grills, 22 inch SMOKEY MOUNTAIN COOKER smoker, GENESIS and SUMMIT gas grills (with warming rack removed) 	<p style="text-align: right;">\$59.49 \$69.49</p> MASTER CARTON: 2 H: 4.94 W: 13.07 D: 20.25 Wt: 7.9 Cu.Ft.: 0.75 INDIVIDUAL CARTON: H: 19.5 W: 12.0 D: 1.5 Wt: 3.2 OUT OF CARTON: H: 22.0 W: 12.1 D: 5.1	 0 77924 04181 5
6470 GRILLING BASKET	 <ul style="list-style-type: none"> Flexible wire accommodates a variety of food sizes and shapes Stainless steel Fits WEBER Q 100/1000 and larger gas grills, SMOKEY JOE and larger charcoal grills 	<p style="text-align: right;">\$40.49 \$45.49</p> MASTER CARTON: 4 H: 9.44 W: 11.32 D: 12.07 Wt: 5.3 Cu.Ft.: 0.74 INDIVIDUAL CARTON: H: 8.19 W: 11.03 D: 2.07 Wt: 0.99 OUT OF CARTON: H: 11.0 W: 8.1 D: 2.2	 0 77924 01113 9



ACCESSORIES



MAP

MSRP



COOKING: RACKS AND ROASTERS



6471	GRILLING BASKET		\$47.99	\$52.99	 0 77924 01084 2		
 <ul style="list-style-type: none"> Flexible wire accommodates a variety of food sizes and shapes Stainless steel Fits WEBER Q 300/3000 and larger gas grills and 18 inch and larger charcoal grills 	MASTER CARTON: 4	H: 12.5	W: 11.32	D: 19.07		Wt: 8.55	Cu.Ft.: 1.56
	INDIVIDUAL CARTON:	H: 11.18	W: 18.11	D: 2.1		Wt: 1.7	
	OUT OF CARTON:	H: 18.1	W: 1.1	D: 2.2			

3400265	ROASTING TRAYS		\$29.99	\$34.99	 0 77924 99818 8		
 <ul style="list-style-type: none"> Creates indirect heat for roasting Sturdy aluminum construction Pack of 10 roasting trays Fits Q 2800N+ gas grill 	MASTER CARTON: 5	H: 17.56	W: 12	D: 3.96		Wt: 1.76	Cu.Ft.: 0.48
	INDIVIDUAL CARTON:	H: 17.13	W: 10.50	D: 0.59		Wt: 0.44	
	OUT OF CARTON:	H: 0.35	W: 12.28	D: 15.35			







3400267	TRAY AND TRIVET ROASTING PACK		\$34.99	\$39.99	 0 77924 99817 1		
 <ul style="list-style-type: none"> Roasting tray creates indirect heat for roasting Trivet made from durable stainless steel Trivet raises food for heat circulation and even cooking Fits Q 2800N+ gas grill 	MASTER CARTON: 5	H: 16.13	W: 10.50	D: 3.32		Wt: 8.76	Cu.Ft.: 0.33
	INDIVIDUAL CARTON:	H: 14.63	W: 9.50	D: 0.57		Wt: 2.19	
	OUT OF CARTON:	H: 0.71	W: 10.87	D: 14.53			

COOKING: ROTISSERIES





3400252	ROTISSERIE		\$129.99	\$139.99	 0 77924 99807 2		
 <ul style="list-style-type: none"> Rotisserie forks designed to hold both large and small cuts of meat Includes stainless-steel shaft, forks, handle, and hardware Fits SEARWOOD 600 pellet grills and SPIRIT gas grills Powered by heavy-duty electric motor 	MASTER CARTON: 1	H: 3.74	W: 20.4	D: 5.3		Wt: 5.75	Cu.Ft.: 0.24
	INDIVIDUAL CARTON:	H: 3.74	W: 20.4	D: 5.3		Wt: 5.75	
	OUT OF CARTON:	H: 5.23	W: 5.56	D: 33.45			

3400246	ROTISSERIE		\$149.99	\$159.99	 0 77924 99806 5		
 <ul style="list-style-type: none"> Rotisserie forks designed to hold both large and small cuts of meat Includes stainless-steel shaft, forks, handle, and hardware Fits GENESIS II and GENESIS II LX 400 series, 2022 GENESIS 400 series gas grills and SEARWOOD XL 600 pellet grills Powered by heavy-duty electric motor 	MASTER CARTON: 1	H: 3.46	W: 44	D: 5.5		Wt: 8.38	Cu.Ft.: 0.49
	INDIVIDUAL CARTON:	H: 3.46	W: 44	D: 5.5		Wt: 8.38	
	OUT OF CARTON:	H: 5.6	W: 4.4	D: 54.9			

COOKING: ROTISSERIES

3400264 ROTISSERIE	 <ul style="list-style-type: none"> Forks designed to hold both large and small cuts of meat Heavy-duty motor supports up to 10 lbs. Includes stainless-steel shaft, forks, handle, and hardware Fits Q 2800N+ gas grill 	<table border="1"> <tr> <td></td> <td>\$134.99</td> <td>\$144.99</td> </tr> <tr> <td colspan="3">MASTER CARTON: 2</td> </tr> <tr> <td>H: 32.87</td> <td>W: 23.6</td> <td>D: 4.92 Wt: 10.8 Cu.Ft.: 2.21</td> </tr> <tr> <td colspan="3">INDIVIDUAL CARTON:</td> </tr> <tr> <td>H: 32.87</td> <td>W: 23.6</td> <td>D: 4.92 Wt: 10.8</td> </tr> <tr> <td colspan="3">OUT OF CARTON:</td> </tr> <tr> <td>H: 8.88</td> <td>W: 37.25</td> <td>D: 16</td> </tr> </table>		\$134.99	\$144.99	MASTER CARTON: 2			H: 32.87	W: 23.6	D: 4.92 Wt: 10.8 Cu.Ft.: 2.21	INDIVIDUAL CARTON:			H: 32.87	W: 23.6	D: 4.92 Wt: 10.8	OUT OF CARTON:			H: 8.88	W: 37.25	D: 16	 <p>0 77924 99815 7</p>
	\$134.99	\$144.99																						
MASTER CARTON: 2																								
H: 32.87	W: 23.6	D: 4.92 Wt: 10.8 Cu.Ft.: 2.21																						
INDIVIDUAL CARTON:																								
H: 32.87	W: 23.6	D: 4.92 Wt: 10.8																						
OUT OF CARTON:																								
H: 8.88	W: 37.25	D: 16																						
7652 ROTISSERIE	 <ul style="list-style-type: none"> Forks designed to hold both large and small cuts of meat Includes stainless steel shaft, forks, handle, and hardware Fits GENESIS II 200/300 series gas grills GENESIS 300 series gas grills (2016+) 	<table border="1"> <tr> <td></td> <td>\$145.49</td> <td>\$155.49</td> </tr> <tr> <td colspan="3">MASTER CARTON: 1</td> </tr> <tr> <td>H: 3.44</td> <td>W: 29.69</td> <td>D: 5.5 Wt: 6.28 Cu.Ft.: 0.32</td> </tr> <tr> <td colspan="3">INDIVIDUAL CARTON:</td> </tr> <tr> <td>H: 5.5</td> <td>W: 29.69</td> <td>D: 3.44 Wt: 6.28</td> </tr> <tr> <td colspan="3">OUT OF CARTON:</td> </tr> <tr> <td>H: 42.1</td> <td>W: 4.4</td> <td>D: 5.6</td> </tr> </table>		\$145.49	\$155.49	MASTER CARTON: 1			H: 3.44	W: 29.69	D: 5.5 Wt: 6.28 Cu.Ft.: 0.32	INDIVIDUAL CARTON:			H: 5.5	W: 29.69	D: 3.44 Wt: 6.28	OUT OF CARTON:			H: 42.1	W: 4.4	D: 5.6	 <p>0 77924 05204 0</p>
	\$145.49	\$155.49																						
MASTER CARTON: 1																								
H: 3.44	W: 29.69	D: 5.5 Wt: 6.28 Cu.Ft.: 0.32																						
INDIVIDUAL CARTON:																								
H: 5.5	W: 29.69	D: 3.44 Wt: 6.28																						
OUT OF CARTON:																								
H: 42.1	W: 4.4	D: 5.6																						
2290 KETTLE ROTISSERIE	 <ul style="list-style-type: none"> Porcelain-enameled ring elevates the rotisserie to optimize grilling space Includes a motor, 2 spit forks, and a shaft This item provided in non-retail, plain brown packaging Fits 22 inch WEBER charcoal grills 	<table border="1"> <tr> <td></td> <td>\$234.99</td> <td>\$284.99</td> </tr> <tr> <td colspan="3">MASTER CARTON: 1</td> </tr> <tr> <td>H: 7.44</td> <td>W: 24.19</td> <td>D: 30.75 Wt: 16.44 Cu.Ft.: 3.2</td> </tr> <tr> <td colspan="3">INDIVIDUAL CARTON:</td> </tr> <tr> <td>H: 30.75</td> <td>W: 24.19</td> <td>D: 7.44 Wt: 16.44</td> </tr> <tr> <td colspan="3">OUT OF CARTON:</td> </tr> <tr> <td>H: 36.0</td> <td>W: 23.4</td> <td>D: 6.3</td> </tr> </table>		\$234.99	\$284.99	MASTER CARTON: 1			H: 7.44	W: 24.19	D: 30.75 Wt: 16.44 Cu.Ft.: 3.2	INDIVIDUAL CARTON:			H: 30.75	W: 24.19	D: 7.44 Wt: 16.44	OUT OF CARTON:			H: 36.0	W: 23.4	D: 6.3	 <p>0 77924 02290 6</p>
	\$234.99	\$284.99																						
MASTER CARTON: 1																								
H: 7.44	W: 24.19	D: 30.75 Wt: 16.44 Cu.Ft.: 3.2																						
INDIVIDUAL CARTON:																								
H: 30.75	W: 24.19	D: 7.44 Wt: 16.44																						
OUT OF CARTON:																								
H: 36.0	W: 23.4	D: 6.3																						

COOKING: GRIDDLES AND GRATES













6787 RUST-RESISTANT GRIDDLE INSERT	 <ul style="list-style-type: none"> Converts SEARWOOD 600, SEARWOOD XL 600, and SPIRIT 300 series gas grills* to a full-size griddle for best-of-both-worlds versatility *2016 and newer Pre-seasoned, ready to use Quick, even heating Warp-resistant carbon steel Integrated grease management 	<table border="1"> <tr> <td></td> <td>\$199.00</td> <td>\$219.00</td> </tr> <tr> <td colspan="3">MASTER CARTON: 1</td> </tr> <tr> <td>H: 20.3</td> <td>W: 26.0</td> <td>D: 3.15 Wt: 22.0 Cu.Ft.: 0.96</td> </tr> <tr> <td colspan="3">INDIVIDUAL CARTON:</td> </tr> <tr> <td>H: 20.3</td> <td>W: 26.0</td> <td>D: 3.15 Wt: 22.0</td> </tr> <tr> <td colspan="3">OUT OF CARTON:</td> </tr> <tr> <td>H: 1.19</td> <td>W: 22.67</td> <td>D: 17.29</td> </tr> </table>		\$199.00	\$219.00	MASTER CARTON: 1			H: 20.3	W: 26.0	D: 3.15 Wt: 22.0 Cu.Ft.: 0.96	INDIVIDUAL CARTON:			H: 20.3	W: 26.0	D: 3.15 Wt: 22.0	OUT OF CARTON:			H: 1.19	W: 22.67	D: 17.29	 <p>0 77924 19374 3</p>
	\$199.00	\$219.00																						
MASTER CARTON: 1																								
H: 20.3	W: 26.0	D: 3.15 Wt: 22.0 Cu.Ft.: 0.96																						
INDIVIDUAL CARTON:																								
H: 20.3	W: 26.0	D: 3.15 Wt: 22.0																						
OUT OF CARTON:																								
H: 1.19	W: 22.67	D: 17.29																						
6788 RUST-RESISTANT GRIDDLE INSERT	 <ul style="list-style-type: none"> Converts GENESIS 300 series gas grills* to a full-size griddle for best-of-both-worlds versatility *2016 and newer Pre-seasoned, ready to use Quick, even heating Warp-resistant carbon steel Integrated grease management 	<table border="1"> <tr> <td></td> <td>\$249.00</td> <td>\$299.00</td> </tr> <tr> <td colspan="3">MASTER CARTON: 1</td> </tr> <tr> <td>H: 21.65</td> <td>W: 29.0</td> <td>D: 3.15 Wt: 26.3 Cu.Ft.: 1.14</td> </tr> <tr> <td colspan="3">INDIVIDUAL CARTON:</td> </tr> <tr> <td>H: 21.65</td> <td>W: 29.0</td> <td>D: 3.15 Wt: 26.3</td> </tr> <tr> <td colspan="3">OUT OF CARTON:</td> </tr> <tr> <td>H: 1.19</td> <td>W: 25.67</td> <td>D: 18.67</td> </tr> </table>		\$249.00	\$299.00	MASTER CARTON: 1			H: 21.65	W: 29.0	D: 3.15 Wt: 26.3 Cu.Ft.: 1.14	INDIVIDUAL CARTON:			H: 21.65	W: 29.0	D: 3.15 Wt: 26.3	OUT OF CARTON:			H: 1.19	W: 25.67	D: 18.67	 <p>0 77924 19375 0</p>
	\$249.00	\$299.00																						
MASTER CARTON: 1																								
H: 21.65	W: 29.0	D: 3.15 Wt: 26.3 Cu.Ft.: 1.14																						
INDIVIDUAL CARTON:																								
H: 21.65	W: 29.0	D: 3.15 Wt: 26.3																						
OUT OF CARTON:																								
H: 1.19	W: 25.67	D: 18.67																						

ACCESSORIES











MAP

MSRP

COOKING: GRIDDLES AND GRATES

3400382	RUST-RESISTANT GRIDDLE INSERT	\$169.99	\$189.99																															
	<ul style="list-style-type: none"> • Pre-seasoned, ready to use • Quick heating • Warp-resistant carbon steel • Grease removal slot • Fits 22" WEBER charcoal grills, excludes 22" COMPACT KETTLES and JUMBO JOE PREMIUM models 	<table border="1"> <tr> <td colspan="5">MASTER CARTON: 1</td> </tr> <tr> <td>H: 2.25</td> <td>W: 23.85</td> <td>D: 25</td> <td>Wt: 27.85</td> <td>Cu.Ft.: 0.78</td> </tr> <tr> <td colspan="5">INDIVIDUAL CARTON:</td> </tr> <tr> <td>H: 2.25</td> <td>W: 23.85</td> <td>D: 25</td> <td>Wt: 27.85</td> <td></td> </tr> <tr> <td colspan="5">OUT OF CARTON:</td> </tr> <tr> <td>H: 4.07</td> <td>W: 21.62</td> <td>D: 21.62</td> <td></td> <td></td> </tr> </table>		MASTER CARTON: 1					H: 2.25	W: 23.85	D: 25	Wt: 27.85	Cu.Ft.: 0.78	INDIVIDUAL CARTON:					H: 2.25	W: 23.85	D: 25	Wt: 27.85		OUT OF CARTON:					H: 4.07	W: 21.62	D: 21.62			0 77924 00737 8
MASTER CARTON: 1																																		
H: 2.25	W: 23.85	D: 25	Wt: 27.85	Cu.Ft.: 0.78																														
INDIVIDUAL CARTON:																																		
H: 2.25	W: 23.85	D: 25	Wt: 27.85																															
OUT OF CARTON:																																		
H: 4.07	W: 21.62	D: 21.62																																
6789	RUST-RESISTANT GRIDDLE INSERT	\$299.00	\$349.00																															
	<ul style="list-style-type: none"> • Converts GENESIS 400 series gas grills* to a full-size griddle for best-of-both-worlds versatility *2016 and newer • Pre-seasoned, ready to use • Quick, even heating • Warp-resistant carbon steel • Integrated grease management 	<table border="1"> <tr> <td colspan="5">MASTER CARTON: 1</td> </tr> <tr> <td>H: 21.65</td> <td>W: 36.0</td> <td>D: 3.15</td> <td>Wt: 33.2</td> <td>Cu.Ft.: 1.42</td> </tr> <tr> <td colspan="5">INDIVIDUAL CARTON:</td> </tr> <tr> <td>H: 21.65</td> <td>W: 36.0</td> <td>D: 3.15</td> <td>Wt: 33.2</td> <td></td> </tr> <tr> <td colspan="5">OUT OF CARTON:</td> </tr> <tr> <td>H: 1.19</td> <td>W: 32.67</td> <td>D: 18.67</td> <td></td> <td></td> </tr> </table>		MASTER CARTON: 1					H: 21.65	W: 36.0	D: 3.15	Wt: 33.2	Cu.Ft.: 1.42	INDIVIDUAL CARTON:					H: 21.65	W: 36.0	D: 3.15	Wt: 33.2		OUT OF CARTON:					H: 1.19	W: 32.67	D: 18.67			0 77924 19376 7
MASTER CARTON: 1																																		
H: 21.65	W: 36.0	D: 3.15	Wt: 33.2	Cu.Ft.: 1.42																														
INDIVIDUAL CARTON:																																		
H: 21.65	W: 36.0	D: 3.15	Wt: 33.2																															
OUT OF CARTON:																																		
H: 1.19	W: 32.67	D: 18.67																																
7034	TRAVELER GRIDDLE	\$99.99	\$109.99																															
	<ul style="list-style-type: none"> • Porcelain-enameled cast-iron material retains heat and requires no seasoning • Surface prevents sticking • Cleans easily with soap and water • Fits WEBER TRAVELER grills • Cleans easily with soap and water 	<table border="1"> <tr> <td colspan="5">MASTER CARTON: 1</td> </tr> <tr> <td>H: 17.95</td> <td>W: 16.45</td> <td>D: 1.15</td> <td>Wt: 9.25</td> <td>Cu.Ft.: 0.2</td> </tr> <tr> <td colspan="5">INDIVIDUAL CARTON:</td> </tr> <tr> <td>H: 17.95</td> <td>W: 16.45</td> <td>D: 1.15</td> <td>Wt: 9.25</td> <td></td> </tr> <tr> <td colspan="5">OUT OF CARTON:</td> </tr> <tr> <td>H: 0.5</td> <td>W: 12.6</td> <td>D: 13.5</td> <td></td> <td></td> </tr> </table>		MASTER CARTON: 1					H: 17.95	W: 16.45	D: 1.15	Wt: 9.25	Cu.Ft.: 0.2	INDIVIDUAL CARTON:					H: 17.95	W: 16.45	D: 1.15	Wt: 9.25		OUT OF CARTON:					H: 0.5	W: 12.6	D: 13.5			0 77924 19405 4
MASTER CARTON: 1																																		
H: 17.95	W: 16.45	D: 1.15	Wt: 9.25	Cu.Ft.: 0.2																														
INDIVIDUAL CARTON:																																		
H: 17.95	W: 16.45	D: 1.15	Wt: 9.25																															
OUT OF CARTON:																																		
H: 0.5	W: 12.6	D: 13.5																																
6611	LUMIN COMPACT GRIDDLE	\$89.99	\$99.99																															
	<ul style="list-style-type: none"> • Make a variety of foods—from eggs and pancakes to fish, vegetables and fruit • Save time—porcelain enamel coating doesn't require seasoning and prevents food from sticking • Designed to replace a grate in a LUMIN COMPACT electric grill 	<table border="1"> <tr> <td colspan="5">MASTER CARTON: 1</td> </tr> <tr> <td>H: 12.5</td> <td>W: 15.6</td> <td>D: 1.35</td> <td>Wt: 9.5</td> <td>Cu.Ft.: 0.15</td> </tr> <tr> <td colspan="5">INDIVIDUAL CARTON:</td> </tr> <tr> <td>H: 12.5</td> <td>W: 15.6</td> <td>D: 1.35</td> <td>Wt: 9.5</td> <td></td> </tr> <tr> <td colspan="5">OUT OF CARTON:</td> </tr> <tr> <td>H: 0.5</td> <td>W: 11.2</td> <td>D: 8.5</td> <td></td> <td></td> </tr> </table>		MASTER CARTON: 1					H: 12.5	W: 15.6	D: 1.35	Wt: 9.5	Cu.Ft.: 0.15	INDIVIDUAL CARTON:					H: 12.5	W: 15.6	D: 1.35	Wt: 9.5		OUT OF CARTON:					H: 0.5	W: 11.2	D: 8.5			0 77924 19420 7
MASTER CARTON: 1																																		
H: 12.5	W: 15.6	D: 1.35	Wt: 9.5	Cu.Ft.: 0.15																														
INDIVIDUAL CARTON:																																		
H: 12.5	W: 15.6	D: 1.35	Wt: 9.5																															
OUT OF CARTON:																																		
H: 0.5	W: 11.2	D: 8.5																																
6612	LUMIN GRIDDLE	\$99.99	\$109.99																															
	<ul style="list-style-type: none"> • Make a variety of foods—from eggs and pancakes to fish, vegetables and fruit • Save time—porcelain enamel coating doesn't require seasoning and prevents food from sticking • Designed to replace a grate in a LUMIN electric grill 	<table border="1"> <tr> <td colspan="5">MASTER CARTON: 1</td> </tr> <tr> <td>H: 13.7</td> <td>W: 17.95</td> <td>D: 1.35</td> <td>Wt: 12.1</td> <td>Cu.Ft.: 0.19</td> </tr> <tr> <td colspan="5">INDIVIDUAL CARTON:</td> </tr> <tr> <td>H: 13.7</td> <td>W: 17.95</td> <td>D: 1.35</td> <td>Wt: 12.1</td> <td></td> </tr> <tr> <td colspan="5">OUT OF CARTON:</td> </tr> <tr> <td>H: 0.5</td> <td>W: 13</td> <td>D: 9.7</td> <td></td> <td></td> </tr> </table>		MASTER CARTON: 1					H: 13.7	W: 17.95	D: 1.35	Wt: 12.1	Cu.Ft.: 0.19	INDIVIDUAL CARTON:					H: 13.7	W: 17.95	D: 1.35	Wt: 12.1		OUT OF CARTON:					H: 0.5	W: 13	D: 9.7			0 77924 19421 4
MASTER CARTON: 1																																		
H: 13.7	W: 17.95	D: 1.35	Wt: 12.1	Cu.Ft.: 0.19																														
INDIVIDUAL CARTON:																																		
H: 13.7	W: 17.95	D: 1.35	Wt: 12.1																															
OUT OF CARTON:																																		
H: 0.5	W: 13	D: 9.7																																
3400247	HALF GRIDDLE	\$79.99	\$89.99																															
	<ul style="list-style-type: none"> • Porcelain-enamel coating requires no seasoning and helps prevent food from sticking • Cast-iron material retains and evenly distributes heat • Cleans easily with soap and water • Fits Q 2800N+ gas grill 	<table border="1"> <tr> <td colspan="5">MASTER CARTON: 1</td> </tr> <tr> <td>H: 19.41</td> <td>W: 13.94</td> <td>D: 1.34</td> <td>Wt: 9.81</td> <td>Cu.Ft.: 0.21</td> </tr> <tr> <td colspan="5">INDIVIDUAL CARTON:</td> </tr> <tr> <td>H: 19.41</td> <td>W: 13.94</td> <td>D: 1.34</td> <td>Wt: 9.81</td> <td></td> </tr> <tr> <td colspan="5">OUT OF CARTON:</td> </tr> <tr> <td>H: 0.25</td> <td>W: 11.13</td> <td>D: 16</td> <td></td> <td></td> </tr> </table>		MASTER CARTON: 1					H: 19.41	W: 13.94	D: 1.34	Wt: 9.81	Cu.Ft.: 0.21	INDIVIDUAL CARTON:					H: 19.41	W: 13.94	D: 1.34	Wt: 9.81		OUT OF CARTON:					H: 0.25	W: 11.13	D: 16			0 77924 99810 2
MASTER CARTON: 1																																		
H: 19.41	W: 13.94	D: 1.34	Wt: 9.81	Cu.Ft.: 0.21																														
INDIVIDUAL CARTON:																																		
H: 19.41	W: 13.94	D: 1.34	Wt: 9.81																															
OUT OF CARTON:																																		
H: 0.25	W: 11.13	D: 16																																

COOKING: GRIDDLES AND GRATES



3400248 GRIDDLE	 <ul style="list-style-type: none"> • Porcelain-enamel coating requires no seasoning and helps prevent food from sticking • Cast-iron material retains and evenly distributes heat • Cleans easily with soap and water • Fits Q 2800N+ gas grill 	<table border="1"> <tr> <td></td> <td>\$118.99</td> <td>\$128.99</td> </tr> <tr> <td colspan="3">MASTER CARTON: 1</td> </tr> <tr> <td>H: 25.03</td> <td>W: 18.58</td> <td>D: 2.17 Wt: 22.6 Cu.Ft.: 0.58</td> </tr> <tr> <td colspan="3">INDIVIDUAL CARTON:</td> </tr> <tr> <td>H: 25.03</td> <td>W: 18.58</td> <td>D: 2.17 Wt: 22.6</td> </tr> <tr> <td colspan="3">OUT OF CARTON:</td> </tr> <tr> <td>H: 1.75</td> <td>W: 22.25</td> <td>D: 16</td> </tr> </table>		\$118.99	\$128.99	MASTER CARTON: 1			H: 25.03	W: 18.58	D: 2.17 Wt: 22.6 Cu.Ft.: 0.58	INDIVIDUAL CARTON:			H: 25.03	W: 18.58	D: 2.17 Wt: 22.6	OUT OF CARTON:			H: 1.75	W: 22.25	D: 16	 <p>0 77924 99811 9</p>
	\$118.99	\$128.99																						
MASTER CARTON: 1																								
H: 25.03	W: 18.58	D: 2.17 Wt: 22.6 Cu.Ft.: 0.58																						
INDIVIDUAL CARTON:																								
H: 25.03	W: 18.58	D: 2.17 Wt: 22.6																						
OUT OF CARTON:																								
H: 1.75	W: 22.25	D: 16																						
6558 WEBER Q GRIDDLE	 <ul style="list-style-type: none"> • Porcelain-enameled, cast-iron griddle provides exceptional heat retention and distribution ensuring evenly cooked food • Designed to replace a cooking grate • Fits WEBER Q 100/1000 series gas grills 	<table border="1"> <tr> <td></td> <td>\$64.99</td> <td>\$74.99</td> </tr> <tr> <td colspan="3">MASTER CARTON: 1</td> </tr> <tr> <td>H: 0.94</td> <td>W: 15.94</td> <td>D: 12.0 Wt: 5.79 Cu.Ft.: 0.1</td> </tr> <tr> <td colspan="3">INDIVIDUAL CARTON:</td> </tr> <tr> <td>H: 10.0</td> <td>W: 15.94</td> <td>D: 10.94 Wt: 5.79</td> </tr> <tr> <td colspan="3">OUT OF CARTON:</td> </tr> <tr> <td>H: 12.6</td> <td>W: 8.6</td> <td>D: 0.5</td> </tr> </table>		\$64.99	\$74.99	MASTER CARTON: 1			H: 0.94	W: 15.94	D: 12.0 Wt: 5.79 Cu.Ft.: 0.1	INDIVIDUAL CARTON:			H: 10.0	W: 15.94	D: 10.94 Wt: 5.79	OUT OF CARTON:			H: 12.6	W: 8.6	D: 0.5	 <p>0 77924 02164 0</p>
	\$64.99	\$74.99																						
MASTER CARTON: 1																								
H: 0.94	W: 15.94	D: 12.0 Wt: 5.79 Cu.Ft.: 0.1																						
INDIVIDUAL CARTON:																								
H: 10.0	W: 15.94	D: 10.94 Wt: 5.79																						
OUT OF CARTON:																								
H: 12.6	W: 8.6	D: 0.5																						
7658 GRIDDLE	 <ul style="list-style-type: none"> • Porcelain-enameled, cast-iron griddle provides exceptional heat retention and distribution ensuring evenly cooked food • Easy to clean semi-gloss enameled surface • Sloped cooking surface helps drain drippings away from food • Fits SPIRIT and SPIRIT II 200/300 series gas grills 	<table border="1"> <tr> <td></td> <td>\$118.99</td> <td>\$128.99</td> </tr> <tr> <td colspan="3">MASTER CARTON: 1</td> </tr> <tr> <td>H: 2.73</td> <td>W: 19.63</td> <td>D: 14.97 Wt: 15.00 Cu.Ft.: 0.46</td> </tr> <tr> <td colspan="3">INDIVIDUAL CARTON:</td> </tr> <tr> <td>H: 14.97</td> <td>W: 19.63</td> <td>D: 2.73 Wt: 15.00</td> </tr> <tr> <td colspan="3">OUT OF CARTON:</td> </tr> <tr> <td>H: 11.6</td> <td>W: 16.8</td> <td>D: 2</td> </tr> </table>		\$118.99	\$128.99	MASTER CARTON: 1			H: 2.73	W: 19.63	D: 14.97 Wt: 15.00 Cu.Ft.: 0.46	INDIVIDUAL CARTON:			H: 14.97	W: 19.63	D: 2.73 Wt: 15.00	OUT OF CARTON:			H: 11.6	W: 16.8	D: 2	 <p>0 77924 05879 0</p>
	\$118.99	\$128.99																						
MASTER CARTON: 1																								
H: 2.73	W: 19.63	D: 14.97 Wt: 15.00 Cu.Ft.: 0.46																						
INDIVIDUAL CARTON:																								
H: 14.97	W: 19.63	D: 2.73 Wt: 15.00																						
OUT OF CARTON:																								
H: 11.6	W: 16.8	D: 2																						
7599 GRIDDLE	 <ul style="list-style-type: none"> • Porcelain-enameled, cast-iron griddle provides exceptional heat retention and distribution ensuring evenly cooked food • Easy to clean semi-gloss enameled surface • Sloped cooking surface helps drain drippings away from food • Fits GENESIS II 300, 400, and 600 series gas grills 	<table border="1"> <tr> <td></td> <td>\$118.99</td> <td>\$128.99</td> </tr> <tr> <td colspan="3">MASTER CARTON: 1</td> </tr> <tr> <td>H: 2.82</td> <td>W: 21.63</td> <td>D: 16.07 Wt: 17.50 Cu.Ft.: 0.56</td> </tr> <tr> <td colspan="3">INDIVIDUAL CARTON:</td> </tr> <tr> <td>H: 16.07</td> <td>W: 21.63</td> <td>D: 2.82 Wt: 17.50</td> </tr> <tr> <td colspan="3">OUT OF CARTON:</td> </tr> <tr> <td>H: 18.9</td> <td>W: 13.2</td> <td>D: 1.5</td> </tr> </table>		\$118.99	\$128.99	MASTER CARTON: 1			H: 2.82	W: 21.63	D: 16.07 Wt: 17.50 Cu.Ft.: 0.56	INDIVIDUAL CARTON:			H: 16.07	W: 21.63	D: 2.82 Wt: 17.50	OUT OF CARTON:			H: 18.9	W: 13.2	D: 1.5	 <p>0 77924 05197 5</p>
	\$118.99	\$128.99																						
MASTER CARTON: 1																								
H: 2.82	W: 21.63	D: 16.07 Wt: 17.50 Cu.Ft.: 0.56																						
INDIVIDUAL CARTON:																								
H: 16.07	W: 21.63	D: 2.82 Wt: 17.50																						
OUT OF CARTON:																								
H: 18.9	W: 13.2	D: 1.5																						
7598 PORCELAIN-ENAMELED CAST IRON GRIDDLE	 <ul style="list-style-type: none"> • 2-sided, porcelain-enameled, cast-iron griddle • Textured side is ideal for paninis • Flat surface for delicate items such as scallops and shrimp • Fits SPIRIT 300 series gas grills 	<table border="1"> <tr> <td></td> <td>\$118.99</td> <td>\$128.99</td> </tr> <tr> <td colspan="3">MASTER CARTON: 1</td> </tr> <tr> <td>H: 1.32</td> <td>W: 21.07</td> <td>D: 14.32 Wt: 16.08 Cu.Ft.: 0.23</td> </tr> <tr> <td colspan="3">INDIVIDUAL CARTON:</td> </tr> <tr> <td>H: 14.32</td> <td>W: 21.07</td> <td>D: 1.32 Wt: 16.08</td> </tr> <tr> <td colspan="3">OUT OF CARTON:</td> </tr> <tr> <td>H: 0.5</td> <td>W: 12.1</td> <td>D: 17.4</td> </tr> </table>		\$118.99	\$128.99	MASTER CARTON: 1			H: 1.32	W: 21.07	D: 14.32 Wt: 16.08 Cu.Ft.: 0.23	INDIVIDUAL CARTON:			H: 14.32	W: 21.07	D: 1.32 Wt: 16.08	OUT OF CARTON:			H: 0.5	W: 12.1	D: 17.4	 <p>0 77924 01914 2</p>
	\$118.99	\$128.99																						
MASTER CARTON: 1																								
H: 1.32	W: 21.07	D: 14.32 Wt: 16.08 Cu.Ft.: 0.23																						
INDIVIDUAL CARTON:																								
H: 14.32	W: 21.07	D: 1.32 Wt: 16.08																						
OUT OF CARTON:																								
H: 0.5	W: 12.1	D: 17.4																						



ACCESSORIES

MAP



MSRP



COOKING: CHARCOAL ACCESSORIES



3400656	CHARCOAL GO ANYWHERE 2 PIECE COOKING GRATE	\$24.99	\$29.99	 0 77924 88988 4			
	<h3>Details coming soon</h3>	MASTER CARTON: 4					
		H: 11.6	W: 5.9		D: 9	Wt: 8.8	Cu.Ft.: 0.4
		INDIVIDUAL CARTON:					
		H: 10.6	W: 8.6	D: 1.4	Wt:		
		OUT OF CARTON:					
		H: 0.3	W: 8	D: 10.1			

3400660	CHARCOAL DIGITAL CONTROL ACCESSORY	\$279.00	\$329.99	 0 77924 88980 6			
	<h3>Details coming soon</h3>	MASTER CARTON: 3					
		H: 20.8	W: 9.5		D: 17	Wt: 28.1	Cu.Ft.: 1.9
		INDIVIDUAL CARTON:					
		H: 20.1	W: 8.6	D: 5.4	Wt: 8.7		
		OUT OF CARTON:					
		H: 10.5	W: 30.3	D: 23			











COOKING: PELLET ACCESSORIES

190001	WEBER PELLETS - GRILLMASTER BLEND	\$19.99	\$22.99	 0 77924 12969 8			
	<ul style="list-style-type: none"> • 20 lb bag • All natural hardwood pellets • Moderate flavor: balance and savory with a mild sweet finish 	50 BAGS PER PALLET					
		H: 28.0	W: 40.0		D: 48.0	Wt: 1,075.0	Cu.Ft.: 31.11
		INDIVIDUAL CARTON:					
		H: 22.5	W: 16.5	D: 3.0	Wt: 20.0 lbs		
		OUT OF CARTON:					
		H: 22.5	W: 16.5	D: 3.0			

190002	WEBER PELLETS - HICKORY	\$19.99	\$22.99	 0 77924 12970 4			
	<ul style="list-style-type: none"> • 20 lb bag • All natural hardwood pellets • Moderate flavor: bold, bacon-like flavor 	50 BAGS PER PALLET					
		H: 28.0	W: 40.0		D: 48.0	Wt: 1,075.0	Cu.Ft.: 31.11
		INDIVIDUAL CARTON:					
		H: 22.5	W: 16.5	D: 3.0	Wt: 20.0 lbs		
		OUT OF CARTON:					
		H: 22.5	W: 16.5	D: 3.0			

190003	WEBER PELLETS - MESQUITE	\$19.99	\$22.99	 0 77924 12971 1			
	<ul style="list-style-type: none"> • 20 lb bag • All natural hardwood pellets • Strong flavor: full bodied, big and rich 	50 BAGS PER PALLET					
		H: 28.0	W: 40.0		D: 48.0	Wt: 1,075.0	Cu.Ft.: 31.11
		INDIVIDUAL CARTON:					
		H: 22.5	W: 16.5	D: 3.0	Wt: 20.0 lbs		
		OUT OF CARTON:					
		H: 22.5	W: 16.5	D: 3.0			

COOKING: PELLET ACCESSORIES













190004	WEBER PELLETS - APPLE		\$19.99	\$22.99	
 <ul style="list-style-type: none"> • 20 lb bag • All natural hardwood pellets • Mild flavor: aromatic, sweet 			50 BAGS PER PALLET		
			H: 28.0 W: 40.0 D: 48.0 Wt: 1,075.0 Cu.Ft.: 31.11		
			INDIVIDUAL CARTON: H: 22.5 W: 16.5 D: 3.0 Wt: 20.0 lbs		
			OUT OF CARTON: H: 22.5 W: 16.5 D: 3.0		
190005	WEBER PELLETS - CHERRY		\$19.99	\$22.99	
 <ul style="list-style-type: none"> • 20 lb bag • All natural hardwood pellets • Mild flavor: subtle, fruity, sweet 			50 BAGS PER PALLET		
			H: 28.0 W: 40.0 D: 48.0 Wt: 1,075.0 Cu.Ft.: 31.11		
			INDIVIDUAL CARTON: H: 22.5 W: 16.5 D: 3.0 Wt: 20.0 lbs		
			OUT OF CARTON: H: 22.5 W: 16.5 D: 3.0		
3400250	SEARWOOD WET SMOKE PAN		\$29.99	\$34.99	
<p>Image coming soon</p> <p>Details coming soon</p>		MASTER CARTON: 1			
		H: 3.25 W: 16.75 D: 10.75 Wt: 2.14 Cu.Ft.: 0.34			
		INDIVIDUAL CARTON: H: 10.2 W: 15.6 D: 2.7 Wt: 1.47			
		OUT OF CARTON: H: 14.9 W: 9.3 D: 2.1			
3400108	SEARWOOD 600 FOLDING FRONT TABLE		\$74.99	\$84.99	
 <ul style="list-style-type: none"> • Fits SEARWOOD 600 wood pellet grill • Easily attaches to the front of the SEARWOOD 600 pellet grill • Adds 280+ square inches of workspace and holds up to 40 lbs. • Locks into place to add prep space • Fold down when not in use 			MASTER CARTON: 1		
			H: 15.53 W: 26.81 D: 3.01 Wt: 8.7 Cu.Ft.: 0.73		
			INDIVIDUAL CARTON: H: 15.53 W: 26.81 D: 3.01 Wt: 8.7		
			OUT OF CARTON: H: 3.4 W: 23.5 D: 12.7		
3400109	SEARWOOD 600 XL FOLDING FRONT TABLE		\$99.99	\$109.99	
 <ul style="list-style-type: none"> • Fits SEARWOOD XL 600 pellet grill • Easily attaches to the front of the SEARWOOD XL 600 pellet grill • Adds 425+ square inches of workspace and holds up to 40 lbs. • Locks into place to add prep space • Fold down when not in use 			MASTER CARTON: 1		
			H: 15.53 W: 38.9 D: 3.01 Wt: 14.5 Cu.Ft.: 1.05		
			INDIVIDUAL CARTON: H: 15.53 W: 38.9 D: 3.01 Wt: 14.5		
			OUT OF CARTON: H: 3.4 W: 35.5 D: 12.7		
3400140	SIDE TABLE		\$74.99	\$84.99	
 <ul style="list-style-type: none"> • Fits SEARWOOD 600 and SEARWOOD XL 600 pellet grills • Adds 200 square inches of workspace and holds up to 40 lbs. of food • Easily folds down for storage • Fits with the SEARWOOD Premium Grill Cover (sold separately) when table is folded up or down 			MASTER CARTON: 1		
			H: 15.53 W: 19.33 D: 3.01 Wt: 7 Cu.Ft.: 0.52		
			INDIVIDUAL CARTON: H: 15.53 W: 19.33 D: 3.01 Wt: 7		
			OUT OF CARTON: H: 3.8 W: 13 D: 16.3		

ACCESSORIES











MAP

MSRP

COOKING: FUEL ACCESSORIES

<p>7666 CHARCOAL HEAT CONTROLLER</p> 	<ul style="list-style-type: none"> Up to 7 hours of low-and-slow temp (225°F-275°F) before refueling Diffuser ring maximizes entire 22" grate for indirect low-and-slow Extreme direct high heat for searing; convection heat for crispy wings 	<p>\$99.99 \$109.99</p> <p>MASTER CARTON: 3 H: 13.5 W: 13.07 D: 20.69 Wt: 21.71 Cu.Ft.: 2.11</p> <p>INDIVIDUAL CARTON: H: 12.25 W: 12.25 D: 6.63 Wt: 6.3</p> <p>OUT OF CARTON: H: 4.5 W: 18.3 D: 18.3</p>	 <p>0 77924 19194 7</p>
<p>7007 FUEL STORAGE BAG</p> 	<ul style="list-style-type: none"> Weather resistant material designed to keep fuel dry & BBQ ready Holds up to 20 lbs of wood pellets or charcoal Designed with a window for labeling different fuel Bag folds flat when not in use Unique bottom handle allows best grip for easy pouring 	<p>\$33.49 \$38.49</p> <p>MASTER CARTON: 4 H: 10.44 W: 6.7 D: 11.62 Wt: 4.84 Cu.Ft.: 0.47</p> <p>INDIVIDUAL CARTON: H: 9.62 W: 6.02 D: 2.32 Wt: 1.04</p> <p>OUT OF CARTON: H: 18.8 W: 11.8 D: 11.8</p>	 <p>0 77924 15309 9</p>
<p>7480 RAPIDFIRE FIRE STARTERS 12PC</p> 	<ul style="list-style-type: none"> Convenient single usage packs for grilling, camping, and fire pits Lights easily when wet Ignites charcoal and wood 	<p>\$6.59 \$7.59</p> <p>MASTER CARTON: 12 H: 6.62 W: 9.65 D: 11.93 Wt: 7.91 Cu.Ft.: 0.44</p> <p>INDIVIDUAL CARTON (12): H: 5.8 W: 4.37 D: 1.81 Wt: 0.58</p> <p>OUT OF CARTON: H: 2.25 W: 1.0 D: 0.5</p>	 <p>0 77924 12258 3</p>
<p>7481 RAPIDFIRE FIRE STARTERS 2PC</p> 	<ul style="list-style-type: none"> Convenient, grab-n-grill or grab-n-light for immediate use Lights easily when wet Ignites charcoal and wood 	<p>\$1.99 \$2.49</p> <p>MASTER CARTON: 24: 2 CLIP STRIPS WITH 12 EACH H: 2.68 W: 4.14 D: 40.44 Wt: 2.75 Cu.Ft.: 0.25</p> <p>INDIVIDUAL CARTON (2): H: 4.25 W: 3.13 D: 0.79 Wt: 0.09</p> <p>OUT OF CARTON: H: 2.25 W: 1.0 D: 0.5</p>	 <p>0 77924 12260 6</p>
<p>7417 LIGHTER CUBES</p> 	<ul style="list-style-type: none"> Light easily, even when wet Use for lighting charcoal grills, smokers, fireplaces, or campfires Box of 24 cubes 	<p>\$5.49 \$6.49</p> <p>MASTER CARTON: 12 H: 7.94 W: 8.88 D: 13.07 Wt: 10.0 Cu.Ft.: 0.56</p> <p>INDIVIDUAL CARTON: H: 8.5 W: 6.25 D: 1.25 Wt: 0.66</p> <p>OUT OF CARTON: H: 1.1 W: 1.1 D: 0.8</p>	 <p>0 77924 07394 6</p>
<p>7416 RAPIDFIRE CHIMNEY STARTER</p> 	<ul style="list-style-type: none"> Convenient and quick way to light charcoal Two handle design provides more control when pouring lit charcoal Works best with WEBER Lighter Cubes and Lighter Packs 	<p>\$25.99 \$30.99</p> <p>MASTER CARTON: 4 H: 12.76 W: 15.75 D: 21.54 Wt: 14.68 Cu.Ft.: 2.5</p> <p>INDIVIDUAL CARTON: H: 12.0 W: 7.5 D: 12.75 Wt: 3.45</p> <p>OUT OF CARTON: H: 12.7 W: 8.1 D: 12.5</p>	 <p>0 77924 07393 9</p>

COOKING: FUEL ACCESSORIES









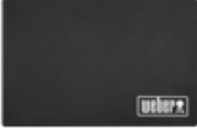

7447	RAPIDFIRE COMPACT CHIMNEY STARTER	\$18.99 \$21.99	 0 77924 01949 4
 <ul style="list-style-type: none"> • Convenient and quick way to light charcoal • Compact design makes it ideal for smaller grills or shorter grilling sessions • Works best with WEBER Lighter Cubes and Lighter Packs 	MASTER CARTON: 4	H: 8.69 W: 12.44 D: 17.38 Wt: 10.88 Cu.Ft.: 1.08	
	INDIVIDUAL CARTON:	H: 8.0 W: 5.75 D: 10.25 Wt: 2.5	
	OUT OF CARTON:	H: 8.0 W: 5.8 D: 9.6	
7649	CHARCOAL RAKE	\$24.49 \$29.49	 0 77924 04183 9
 <ul style="list-style-type: none"> • Designed to safely and conveniently arrange lit charcoal • Stainless steel 	MASTER CARTON: 4	H: 4.69 W: 21.82 D: 9.5 Wt: 3.94 Cu.Ft.: 0.56	
	INDIVIDUAL CARTON:	H: 4.0 W: 21.0 D: 1.88 Wt: 0.67	
	OUT OF CARTON:	H: 21 W: 3.9 D: 1.9	
7403	CHAR-BASKETS	\$25.99 \$30.99	 0 77924 07383 0
 <ul style="list-style-type: none"> • Fill the CHAR-BASKETS with coal to easily and evenly set up for direct or indirect grilling • Set of two baskets • Fits 18 inch WEBER charcoal grills, 22 inch WEBER charcoal grills, and 26 inch WEBER charcoal grills 	MASTER CARTON: 4	H: 17.44 W: 11.07 D: 11.57 Wt: 9.28 Cu.Ft.: 1.29	
	INDIVIDUAL CARTON:	H: 16.82 W: 5.38 D: 5.07 Wt: 2.2	
	OUT OF CARTON:	H: 14.2 W: 3.6 D: 3.1	
6613	VERSATILITY EXPANSION KIT – LUMIN COMPACT ELECTRIC GRILL	\$69.99 \$79.99	 0 77924 19651 5
 <ul style="list-style-type: none"> • Electric smoker conversion for low-and-slow-cooked favorites like ribs and pork shoulder • Two warming dishes to keep food warm and ready for buffet-style serving • Steam expansion enables use of entire grilling surface to steam seafood and veggies • Includes: Steaming/Smoking Reservoir, Reversible Steam Pan and Warming Dishes (2) 	MASTER CARTON: 1	H: 11.0 W: 12.4 D: 3.55 Wt: 4.3 Cu.Ft.: 0.28	
	INDIVIDUAL CARTON:	H: 11.0 W: 12.4 D: 3.55 Wt: 4.3	
	OUT OF CARTON:	H: 2.58 W: 8.48 D: 11.12	
6614	VERSATILITY EXPANSION KIT – LUMIN ELECTRIC GRILL	\$79.99 \$89.99	 0 77924 19652 2
 <ul style="list-style-type: none"> • Electric smoker conversion for low-and-slow-cooked favorites like ribs and pork shoulder • Two warming dishes to keep food warm and ready for buffet-style serving • Steam expansion enables use of entire grilling surface to steam seafood and veggies • Includes: Steaming/Smoking Reservoir, Reversible Steam Pan and Warming Dishes (2) 	MASTER CARTON: 1	H: 12.2 W: 14.4 D: 3.55 Wt: 5.5 Cu.Ft.: 0.36	
	INDIVIDUAL CARTON:	H: 12.2 W: 14.4 D: 3.55 Wt: 5.5	
	OUT OF CARTON:	H: 3.79 W: 9.72 D: 13.05	

ACCESSORIES











MAP

MSRP

PREP AND SERVE: SPECIALTY ACCESSORIES

7017	SILICONE GRILLING GLOVES	\$24.49	\$29.49		
	<ul style="list-style-type: none"> • Reusable • Food-grade and FDA compliant silicone • Easy-to-clean with soap and water, hand wash only • One size fits most • Heat resistant up to 400° Fahrenheit 	MASTER CARTON: 6			
	H: 11.19 W: 8.0 D: 5.71 Wt: 3.82 Cu.Ft.: 0.0				
	INDIVIDUAL CARTON:				
	H: 10.2 W: 7.3 D: 0.8 Wt: 0.6				
OUT OF CARTON:		H: 10.83 W: 7.68 D: N/A			
7696	FLOOR PROTECTION MAT	\$48.99	\$53.99		
	<ul style="list-style-type: none"> • Large surface area protects and covers the surface beneath your grill • Heat resistant and weather resistant • Anti-bacterial and quick drying • Smooth surface makes rolling up and storage easy • Compatible with a variety of grill sizes from an 18" kettle to a 4-burner gas grill 	MASTER CARTON: 6			
	H: 31.7 W: 6.8 D: 10.2 Wt: 3.3 Cu.Ft.: 1.3				
	INDIVIDUAL CARTON:				
	H: 31.5 W: 3.2 D: 3.2 Wt: 0.6				
OUT OF CARTON:		H: 0.1 W: 31.5 D: 47.2			
7031	WEBER TRAVELER REVERSIBLE PREP & SERVE	\$37.99	\$42.99		
	<ul style="list-style-type: none"> • Form-fitted to the WEBER TRAVELER grill side table • Reversible for prep and serve options • Non-slip grips keep board in place during use • Knife-friendly surface • Juice groove to collect juices from foods 	MASTER CARTON: 6			
	H: 24.53 W: 8.86 D: 12.21 Wt: 10.07 Cu.Ft.: 1.54				
	INDIVIDUAL CARTON:				
	H: 9.3 W: 13.6 D: 0.4 Wt: 0.5				
OUT OF CARTON:		H: 0.52 W: 13.75 D: 9.48			
3400127	WEBER WORKS CUTTING BOARD	\$59.99	\$69.99		
	<ul style="list-style-type: none"> • Drops into Weber Works™ side table to create a prep space • 2-sided cutting board to prep or serve on either side • Juice groove keeps liquids away from food and countertops • Dishwasher safe • Weber Works™ System comes on Slate™ Griddles and Expandable Stand • Explore all Weber Works™ Prep, Cook, and Store System accessories 	MASTER CARTON: 6			
	H: 3.6 W: 15.75 D: 20.5 Wt: 31.95 Cu.Ft.: 0.67				
	INDIVIDUAL CARTON:				
	H: 0.35 W: 14.4 D: 18.9 Wt: 5.1				
OUT OF CARTON:		H: 0.35 W: 14.4 D: 18.9			
7005	CUTTING BOARD	\$40.49	\$45.49		
	<ul style="list-style-type: none"> • Grooved edges catch meat juices for mess-free carving • Perfect size for prepping & serving on your WEBER grill side table • Knife-friendly and dishwasher safe for easy cleanup • Fits and stores in the SMOKEFIRE Folding Side Table accessory 	MASTER CARTON: 6			
	H: 11.42 W: 18.5 D: 6.5 Wt: 15.33 Cu.Ft.: 0.79				
	INDIVIDUAL CARTON:				
	H: 10.75 W: 17.72 D: 0.28 Wt: 2.34				
OUT OF CARTON:		H: 0.3 W: 17.6 D: 10.7			
7008	BUTCHER PAPER	\$53.99	\$63.99		
	<ul style="list-style-type: none"> • Use when smoking meats low-and-slow to retain moisture. • Food-grade butcher paper with food-grade ink, safe to be used on food • Unwaxed, uncoated, unbleached for food safety • 18 inches x 150 feet 	MASTER CARTON: 1			
	H: 4.0 W: 19.13 D: 3.82 Wt: 3.5 Cu.Ft.: 0.17				
	INDIVIDUAL CARTON:				
	H: 4.0 W: 19.13 D: 3.82 Wt: 3.5				
OUT OF CARTON:		H: 3.13 W: 18.0 D: 3.13			

PREP AND SERVE: SPECIALTY ACCESSORIES

6691	PIZZA PADDLE	 <ul style="list-style-type: none"> Stainless steel paddle lifts and transports pizzas to and from the grill Handle rotates for compact storage 	<p>\$47.99 \$52.99</p> <p>MASTER CARTON: 4 H: 7.75 W: 13.13 D: 16.07 Wt: 8.0 Cu.Ft.: 0.94</p> <p>INDIVIDUAL CARTON: H: 15.0 W: 12.38 D: 1.75 Wt: 1.74</p> <p>OUT OF CARTON: H: 12.4 W: 24.8 D: 3.1</p>	 <p>0 77924 03183 0</p>
6483	BURGER PRESS	 <ul style="list-style-type: none"> Designed to make a dimple in patties for flat, uniform burgers Press designed to make both 1/2 and 1/4 pound patties Removable handle for easy storage 	<p>\$15.49 \$18.49</p> <p>MASTER CARTON: 6 H: 12.82 W: 6.07 D: 12.32 Wt: 3.4 Cu.Ft.: 0.55</p> <p>INDIVIDUAL CARTON: H: 5.41 W: 5.11 D: 3.43 Wt: 0.48</p> <p>OUT OF CARTON: H: 5.5 W: 4.5 D: 3.0</p>	 <p>0 77924 01202 0</p>
3400075	TOOL MAT	 <ul style="list-style-type: none"> Heat-resistant silicone material is durable and easy to clean Keeps grill side tables clean and protects surfaces from scratching Holds multiple grilling tools at once Raised edges keep grease and food debris contained Dishwasher safe for easy cleanup 	<p>\$24.99 \$29.99</p> <p>MASTER CARTON: 6 H: 3.94 W: 12.2 D: 9.72 Wt: 6.5 Cu.Ft.: 0.27</p> <p>INDIVIDUAL CARTON: H: 8.98 W: 9.04 D: 0.61 Wt: 1</p> <p>OUT OF CARTON: H: 0.60 W: 11 D: 9</p>	 <p>0 77924 99020 5</p>
3400134	XL FLOOR MAT	 <ul style="list-style-type: none"> Extra-large surface area protects and covers the surface beneath your grill Heat resistant and weather resistant Smooth surface makes rolling up and storage easy Long-lasting durability 	<p>\$119.99 \$129.99</p> <p>MASTER CARTON: 6 H: 42 W: 18.9 D: 12.7 Wt: 41 Cu.Ft.: 5.83</p> <p>INDIVIDUAL CARTON: H: 6.5 W: 39 D: 6.5 Wt: 39</p> <p>OUT OF CARTON: H: 0.19 W: 74 D: 38.6</p>	 <p>0 77924 99306 0</p>
3400125	PORTABLE TOOLS BACKPACK	 <ul style="list-style-type: none"> Easily transport your grilling tools, plates, and utensils Fits Weber® Portable Grill Tools and Weber® Portable Griddle Tools Specially designed sections to hold tools, plates, utensils Straps to your back for easy mobility Water-repellent material keeps tools dry 	<p>\$69.99 \$79.99</p> <p>MASTER CARTON: 4 H: 15.5 W: 12.5 D: 4.5 Wt: 5 Cu.Ft.: 0.50</p> <p>INDIVIDUAL CARTON: H: 1.8 W: 16.55 D: 13.4 Wt: 1</p> <p>OUT OF CARTON: H: 15 W: 12 D: 4.70</p>	 <p>0 77924 99283 4</p>
6489	CORN HOLDER SET	 <ul style="list-style-type: none"> Nylon grip with thumb groove for secure and comfortable handling Picks interlock for optimized storage in case Stainless steel Includes eight corn picks 	<p>\$16.99 \$19.99</p> <p>MASTER CARTON: 4 H: 8.38 W: 5.25 D: 5.25 Wt: 1.62 Cu.Ft.: 0.13</p> <p>INDIVIDUAL CARTON: H: 5.57 W: 4.19 D: 1.04 Wt: 0.3</p> <p>OUT OF CARTON: H: 3.8 W: 0.6 D: 0.2</p>	 <p>0 77924 01892 3</p>

ACCESSORIES



MAP

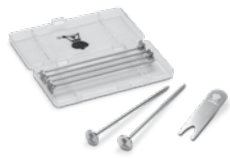

MSRP



PREP AND SERVE: SPECIALTY ACCESSORIES



6488	POTATO NAILS		\$16.99	\$19.99	 0 77924 01891 6		
 <ul style="list-style-type: none"> Heat conducted through stainless steel nail provides quick and even cooking of potato Includes tool for easy removal of nail from potato Plastic case for easy storage Set of six 	MASTER CARTON: 4	H: 7.5	W: 6.26	D: 4.07		Wt: 1.42	Cu.Ft.: 0.11
	INDIVIDUAL CARTON:	H: 4.72	W: 5.34	D: 0.84		Wt: 0.27	
	OUT OF CARTON:	H: 4.7	W: 0.6	D: 0.6			

PREP AND SERVE: MITTS, GLOVES, AND APRONS













6532	BARBECUE MITT		\$13.49	\$16.49	 0 77924 04516 5		
 <ul style="list-style-type: none"> Black mitt with red kettle embroidery Foldable cuff adjusts length for fit 100% cotton with heat-resistant liner 	MASTER CARTON: 6	H: 6.44	W: 7.69	D: 16.38		Wt: 3.68	Cu.Ft.: 0.46
	INDIVIDUAL CARTON:	H: 15.62	W: 2.75	D: 1.0		Wt: 0.42	
	OUT OF CARTON:	H: 15.8	W: 8.9	D: 0.8			

6533	APRON		\$16.99	\$19.99	 0 77924 04517 2		
 <ul style="list-style-type: none"> Black apron, red kettle Adjustable neckband for a customized fit Deep front pocket for holding grilling tools Front towel loop Machine washable One size fits most 	MASTER CARTON: 6	H: 11.13	W: 7.0	D: 8.0		Wt: 5.0	Cu.Ft.: 0.36
	INDIVIDUAL CARTON:	H: 10.5	W: 6.57	D: 1.38		Wt: 0.56	
	OUT OF CARTON:	H: 46.5	W: 25.4	D: 0.2			

6534	APRON	\$11.02	\$16.99	\$19.99	 0 77924 04518 9		
 <ul style="list-style-type: none"> Red apron, black kettle Adjustable neckband for a customized fit Deep front pocket for holding grilling tools Front towel loop Machine washable One size fits most 	MASTER CARTON: 6	H: 11.13	W: 7.0	D: 8.0		Wt: 5.0	Cu.Ft.: 0.36
	INDIVIDUAL CARTON:	H: 10.5	W: 6.57	D: 1.38		Wt: 0.56	
	OUT OF CARTON:	H: 46.5	W: 25.4	D: 0.2			

6535	PREMIUM GLOVES	\$27.54	\$48.99	\$53.99	 0 77924 04519 6		
 <ul style="list-style-type: none"> Silicone palm for gripping grilling tools Flexible, heat resistant material for easy handling of grilling tools and grill lid Size: L/XL 	MASTER CARTON: 6	H: 8.94	W: 6.19	D: 14.94		Wt: 3.62	Cu.Ft.: 0.47
	INDIVIDUAL CARTON:	H: 7.88	W: 5.25	D: 2.19		Wt: 0.49	
	OUT OF CARTON:	H: 13.5	W: 6.7	D: 0.3			

PREP AND SERVE: SMOKING ACCESSORIES













<p>7576 SMOKER BOX</p> 	<ul style="list-style-type: none"> • Universal design for smoking on top of the cooking grates • Stainless steel • Fits WEBER Q 200/2000 series and larger gas grills 	<p>\$33.49 \$38.49</p> <p>MASTER CARTON: 4 H: 11.0 W: 5.63 D: 11.38 Wt: 6.76 Cu.Ft.: 0.4</p> <p>INDIVIDUAL CARTON: H: 9.82 W: 4.76 D: 2.44 Wt: 1.46</p> <p>OUT OF CARTON: H: 9.7 W: 4.7 D: 2.0</p>	 <p>0 77924 01120 7</p>
<p>17302 FIRESPICE CEDAR PLANKS</p> 	<ul style="list-style-type: none"> • Subtle woody flavor • Large planks fit full salmon fillets • Two planks per pack 	<p>\$10.99 \$13.99</p> <p>MASTER CARTON: 6 H: 15.38 W: 6.5 D: 5.32 Wt: 5.85 Cu.Ft.: 0.3</p> <p>INDIVIDUAL CARTON: H: 5.75 W: 0.79 D: 0.4 Wt: 0.9</p> <p>OUT OF CARTON: H: 15.0 W: 5.5 D: 0.3</p>	 <p>0 77924 01197 9</p>
<p>17136 PECAN WOOD CHIPS</p> 	<p>Rich sweet flavor 192 cu. in. (0.003 m³)</p>	<p>\$4.49 \$5.49</p> <p>MASTER CARTON: 12 H: 7.0 W: 19.0 D: 21.0 Wt: 24.0 Cu.Ft.: 1.62</p> <p>INDIVIDUAL BAG: H: 12.5 W: 8.0 D: 2.5 Wt: 2.0</p>	 <p>0 77924 05145 6</p>
<p>17137 PECAN WOOD CHUNKS</p> 	<p>Rich sweet flavor 350 cu. in. (0.006 m³)</p>	<p>\$7.69 \$8.69</p> <p>MASTER CARTON: 6 H: 8.5 W: 15.0 D: 23.0 Wt: 24.0 Cu.Ft.: 1.69</p> <p>INDIVIDUAL BAG: H: 16.0 W: 10.5 D: 4.0 Wt: 4.0</p>	 <p>0 77924 05146 3</p>
<p>17138 APPLE WOOD CHIPS</p> 	<p>Subtle sweet flavor 192 cu. in. (0.003 m³)</p>	<p>\$4.49 \$5.49</p> <p>MASTER CARTON: 12 H: 7.0 W: 19.0 D: 21.0 Wt: 24.0 Cu.Ft.: 1.62</p> <p>INDIVIDUAL BAG: H: 12.5 W: 8.0 D: 2.5 Wt: 2.0</p>	 <p>0 77924 05147 0</p>
<p>17139 APPLE WOOD CHUNKS</p> 	<p>Subtle sweet flavor 350 cu. in. (0.006 m³)</p>	<p>\$7.69 \$8.69</p> <p>MASTER CARTON: 6 H: 8.5 W: 15.0 D: 23.00 Wt: 24.0 Cu.Ft.: 1.69</p> <p>INDIVIDUAL BAG: H: 16.0 W: 10.5 D: 4.0 Wt: 4.0</p>	 <p>0 77924 05148 7</p>

ACCESSORIES











MAP

MSRP

PREP AND SERVE: SMOKING ACCESSORIES

17140		Subtle fruity flavor 192 cu. in. (0.003 m³)	\$4.49 \$5.49		 0 77924 05149 4			
			MASTER CARTON: 12					
			H: 7.0	W: 19.0		D: 21.0	Wt: 24.0	Cu.Ft.: 1.62
			INDIVIDUAL BAG:					
			H: 12.5	W: 8.0	D: 2.5	Wt: 2.0		
17142		Subtle fruity flavor 350 cu. in. (0.006 m³)	\$7.69 \$8.69		 0 77924 05150 0			
			MASTER CARTON: 6					
			H: 8.5	W: 15.0		D: 23.00	Wt: 24.0	Cu.Ft.: 1.69
			INDIVIDUAL BAG:					
			H: 16.0	W: 10.5	D: 4.0	Wt: 4.0		
17143		Rich subtly sweet flavor 192 cu. in. (0.003 m³)	\$4.49 \$5.49		 0 77924 05151 7			
			MASTER CARTON: 12					
			H: 7.0	W: 19.0		D: 21.0	Wt: 24.0	Cu.Ft.: 1.62
			INDIVIDUAL BAG:					
			H: 12.5	W: 8.0	D: 2.5	Wt: 2.0		
17148		Rich subtly sweet flavor 350 cu. in. (0.006 m³)	\$7.69 \$8.69		 0 77924 05152 4			
			MASTER CARTON: 6					
			H: 8.5	W: 15.0		D: 23.0	Wt: 24.0	Cu.Ft.: 1.69
			INDIVIDUAL BAG:					
			H: 16.0	W: 10.5	D: 4.0	Wt: 4.0		
17149		Big bold flavor 192 cu. in. (0.003 m³)	\$4.49 \$5.49		 0 77924 05153 1			
			MASTER CARTON: 12					
			H: 7.0	W: 19.0		D: 21.0	Wt: 24.0	Cu.Ft.: 1.62
			INDIVIDUAL BAG:					
			H: 12.5	W: 8.0	D: 2.5	Wt: 2.0		
17150		Big bold flavor 350 cu. in. (0.006 m³)	\$7.69 \$8.69		 0 77924 05155 5			
			MASTER CARTON: 6					
			H: 8.5	W: 15.0		D: 23.0	Wt: 24.0	Cu.Ft.: 1.69
			INDIVIDUAL BAG:					
			H: 16.0	W: 10.5	D: 4.0	Wt: 4.0		

CARE: CLEANING PRODUCTS



8025	STUBBORN STAIN REMOVER 6OZ	\$13.49	\$16.49	
	<ul style="list-style-type: none"> Removes stubborn stains on grill associated with grease, varnishing, and carbonization Safe on painted steel and porcelain-enamel Includes scratch-free applicator 	MASTER CARTON: 6		
		H: 8 W: 5.5 D: 7.5 Wt: 4.0 Cu.Ft.: 0.19		
		INDIVIDUAL CARTON:		
		H: 7.25 W: 2.0 D: 2.0 Wt: 0.7		
8026	GRILL GRATE SCRUBBER	\$10.49	\$13.49	
	<ul style="list-style-type: none"> Designed for heavy-duty grill cleaning Contoured handle offers a firm, comfortable grip Includes 3 pads for quick and easy replacement 	MASTER CARTON: 6		
		H: 7.00 W: 5.40 D: 13.25 Wt: 2.0 Cu.Ft.: 0.29		
		INDIVIDUAL CARTON:		
		H: 6.0 W: 3.0 D: 4.0 Wt: 0.25		
8027	GRATE GRILL CLEANER 16OZ	\$10.49	\$13.49	
	<ul style="list-style-type: none"> Safe for your cooking grate surfaces Formula that is non-toxic and safe on skin Non-flammable, non-corrosive, biodegradable, and phosphate free Works on grills, smokers, ovens, microwaves, and more 	MASTER CARTON: 6		
		H: 11.5 W: 6.25 D: 8.25 Wt: 8.0 Cu.Ft.: 0.34		
		INDIVIDUAL CARTON:		
		H: 10.85 W: 3.75 D: 2.0 Wt: 1.3		
8028	EXTERIOR GRILL CLEANER 16OZ	\$10.49	\$13.49	
	<ul style="list-style-type: none"> Streak-free formula cleans exterior grill surfaces Removes water spots, grease, and grime Works great on painted steel, stainless steel, and porcelain-enamel surfaces Use with sponge, towel or high-quality paper towel 	MASTER CARTON: 6		
		H: 11.5 W: 6.25 D: 8.25 Wt: 8.0 Cu.Ft.: 0.34		
		INDIVIDUAL CARTON:		
		H: 10.85 W: 3.75 D: 2.0 Wt: 1.3		
8029	STAINLESS STEEL POLISH 12OZ	\$18.49	\$21.49	
	<ul style="list-style-type: none"> Cleans, polishes, and protects grill elements in one step Removes fingerprints, dirt, and water marks Works on indoor stainless-steel appliances Fresh and clean citrus fragrance 	MASTER CARTON: 6		
		H: 11.5 W: 6.25 D: 8.25 Wt: 5.8 Cu.Ft.: 0.34		
		INDIVIDUAL CARTON:		
		H: 10.85 W: 3.75 D: 2.0 Wt: 0.9		
3400713	COLD CLEAN GRILL BRUSH 12"	\$9.99	\$10.99	
Image coming soon	Details coming soon	MASTER CARTON: 12		
		H: 4.1 W: 13.4 D: 13.4 Wt: 3.5 Cu.Ft.: 0.4		
		INDIVIDUAL CARTON:		
		H: 1.1 W: 6 D: 12.2 Wt:		
		OUT OF CARTON:		
		H: 12 W: 7 D: 1		



ACCESSORIES



MAP

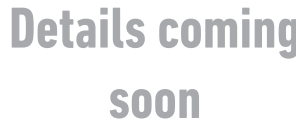

MSRP



CARE: BRUSHES AND TOOLS



3400714	COLD CLEAN GRILL BRUSH 18"		\$12.99	\$15.99	 0 77924 89328 5		
 Image coming soon	 Details coming soon	MASTER CARTON: 12					
		H: 4.1	W: 13.4	D: 19.3		Wt: 4.5	Cu.Ft.: 0.1
		INDIVIDUAL CARTON:					
		H: 1.1	W: 6	D: 18.2	Wt:		
		OUT OF CARTON:					
		H: 18	W: 7	D: 1			

6275	12" BAMBOO GRILL BRUSH		\$14.49	\$17.49	 0 77924 15950 3		
	<ul style="list-style-type: none"> • Designed to easily and efficiently brush away residue • Angled bristle head increase distance from heat for safety • 12 in. long to reach all areas of the grate • Loop to hang brush for easy storage • Compliant to CSA Standards • 2-year warranty 	MASTER CARTON: 12					
		H: 12.4	W: 5.9	D: 10.4		Wt: 6.6	Cu.Ft.: 0.4
		INDIVIDUAL CARTON:					
		H: 11.7	W: 2.4	D: 0.5	Wt: 0.5		
		OUT OF CARTON:					
		H: 12.0	W: 2.25	D: 2.12			



6276	18" BAMBOO GRILL BRUSH		\$17.99	\$20.99	 0 77924 15951 0		
	<ul style="list-style-type: none"> • Designed to easily and efficiently brush away residue • Angled bristle head increase distance from heat for safety • 18 in. long to reach all areas of the grate • Loop to hang brush for easy storage • Compliant to CSA Standards • 2-year warrant 	MASTER CARTON: 12					
		H: 18.7	W: 5.9	D: 10.4		Wt: 7.6	Cu.Ft.: 0.7
		INDIVIDUAL CARTON:					
		H: 17.7	W: 2.4	D: 2.1	Wt: 0.6		
		OUT OF CARTON:					
		H: 17.5	W: 2.25	D: 2.12			

6277	12" THREE-SIDED GRILL BRUSH		\$15.49	\$18.49	 0 77924 15952 7		
	<ul style="list-style-type: none"> • 3-sided bristle brush design easily cleans larger areas quickly • Shorter sides clean edges and dislodge debris between grates • Comfort-hold handle for leverage when cleaning stuck on food • 12 in. long to reach all areas of the grate • Loop to hang brush for easy storage • 2-year warranty 	MASTER CARTON: 12					
		H: 13.6	W: 7.7	D: 17.6		Wt: 5.7	Cu.Ft.: 1.1
		INDIVIDUAL CARTON:					
		H: 12.3	W: 6.7	D: 1.4	Wt: 0.5		
		OUT OF CARTON:					
		H: 12.0	W: 7.0	D: 1.0			



6278	18" THREE-SIDED GRILL BRUSH		\$18.99	\$21.99	 0 77924 15953 4		
	<ul style="list-style-type: none"> • 3-sided bristle brush design easily cleans larger areas quickly • Shorter sides clean edges and dislodge debris between grates • Comfort-hold handle for leverage when cleaning stuck on food • 18 in. long to reach all areas of the grate • Loop to hang brush for easy storage • 2-year warranty 	MASTER CARTON: 12					
		H: 19.0	W: 7.7	D: 17.6		Wt: 8.2	Cu.Ft.: 1.5
		INDIVIDUAL CARTON:					
		H: 17.9	W: 6.6	D: 1.4	Wt: 0.6		
		OUT OF CARTON:					
		H: 18.0	W: 7.0	D: 1.0			



6279	18" DETAIL BRUSH		\$17.99	\$20.99	 0 77924 15954 1		
	<ul style="list-style-type: none"> • 18 in. handle helps reach and clean all areas of the grill • Comfort-hold handle for leverage when cleaning stuck on food • Loop to hang brush for easy storage • 2-year warranty 	MASTER CARTON: 12					
		H: 18.8	W: 5.2	D: 9.4		Wt: 7.1	Cu.Ft.: 0.5
		INDIVIDUAL CARTON:					
		H: 17.4	W: 2.2	D: 1.5	Wt: 0.5		
		OUT OF CARTON:					
		H: 17.5	W: 2.25	D: 1.0			



CARE: BRUSHES AND TOOLS

7459	WOOD GRILL SCRAPER		\$33.49	\$38.49			
 <ul style="list-style-type: none"> • Conforms to grates for efficient removal of buildup and residue • Specially designed for easy handling • Made of durable hardwood • Thick, heavy-duty scraper edge for long-lasting use • Fits different grate types 	MASTER CARTON: 6	H: 7.68	W: 6.93	D: 19.61		Wt: 6.06	Cu.Ft.: 0.6
	INDIVIDUAL CARTON:	H: 17.83	W: 5.59	D: 0.79		Wt: 1.23	
	OUT OF CARTON:	H: 17.83	W: 5.59	D: 0.79			

CARE: DRIP PANS

6415	DRIP PANS		\$10.49	\$13.49			
 <ul style="list-style-type: none"> • Foil liners for grease catch pan • 10 pans per pack • Fits WEBER Q grills, WEBER TRAVELER, SPIRIT gas grills, SPIRIT II gas grills, GENESIS gas grills, GENESIS II 200 & 300 series gas grills, and PULSE electric grills 	MASTER CARTON: 10	H: 9.57	W: 12.69	D: 9.69		Wt: 4.0	Cu.Ft.: 0.68
	INDIVIDUAL CARTON:	H: 10.0	W: 6.0	D: 2.5		Wt: 0.32	
	OUT OF CARTON:	H: 8.6	W: 6.0	D: 1.3			

6498	DRIP PANS		\$15.49	\$18.49			
 <ul style="list-style-type: none"> • Foil liners for grease catch pan • 10 pans per pack • Fits SMOKEFIRE, SEARWOOD 600 and SEARWOOD XL 600 pellet grills, GENESIS II 400 and 600 series gas grills, SUMMIT 400/600 series, and SUMMIT Gold/Platinum 6-burner models 	MASTER CARTON: 4	H: 11.82	W: 5.57	D: 11.94		Wt: 4.06	Cu.Ft.: 0.45
	INDIVIDUAL CARTON:	H: 11.38	W: 4.75	D: 2.86		Wt: 1.02	
	OUT OF CARTON:	H: 11.0	W: 5.0	D: 2.5			



6416	FOIL PANS		\$13.49	\$16.49			
 <ul style="list-style-type: none"> • Disposable pans for transporting food to and from the grill • Use with rotisseries, roast racks, or between CHAR-BASKETS for indirect cooking • Fits SMOKEFIRE Wet Smoke Kit • 10 pans per pack 	MASTER CARTON: 6	H: 14.07	W: 9.94	D: 13.69		Wt: 6.0	Cu.Ft.: 1.1
	INDIVIDUAL CARTON:	H: 13.19	W: 9.32	D: 3.5		Wt: 0.8	
	OUT OF CARTON:	H: 13.1	W: 9.1	D: 2.0			



ACCESSORIES

MAP



MSRP



CARE: COVERS - ELECTRIC



7196	PREMIUM GRILL COVER		\$74.99	\$84.99	 0 77924 19529 7		
	<ul style="list-style-type: none"> Fits LUMIN/LUMIN COMPACT electric grill on the stand Resists fading with UV-inhibiting fabric Shields grill from rain and snow with weather-resistant fabric Secures in place with 4 fastening straps that connect to stand 	MASTER CARTON: 5					
		H: 13.5	W: 7.5	D: 9.8		Wt: 9.8	Cu.Ft.: 0.57
		INDIVIDUAL CARTON:					
		H: 10.5	W: 6.65	D: 2.45		Wt: 1.7	
OUT OF CARTON:			H: 30.5	W: 23.5	D: 23.5		

7197	PREMIUM GRILL COVER		\$39.99	\$44.99	 0 77924 19530 3		
	<ul style="list-style-type: none"> Fits LUMIN/LUMIN COMPACT electric grill without stand Resists fading with UV-inhibiting fabric Shields grill from rain and snow with weather-resistant fabric Secures in place with 2 drawstring pulls 	MASTER CARTON: 4					
		H: 4.65	W: 10.95	D: 9.5		Wt: 2.65	Cu.Ft.: 0.28
		INDIVIDUAL CARTON:					
		H: 7.5	W: 3.95	D: 2.5		Wt: 0.45	
OUT OF CARTON:			H: 10.5	W: 20.3	D: 18.5		

CARE: COVERS - TRAVELER

3400335	PREMIUM GRILL COVER		\$54.99	\$64.99	 0 77924 00383 7		
	<ul style="list-style-type: none"> Weather-resistant fabric shields your grill from rain and snow Made from durable, polyester material Lightweight design makes covering and uncovering easy Compatible with WEBER TRAVELER COMPACT grill Fastening straps keep the cover secure once in place 	MASTER CARTON: 4					
		H: 11.7	W: 8.15	D: 10.65		Wt: 7.9	Cu.Ft.: 0.59
		INDIVIDUAL CARTON:					
		H: 11.2	W: 7.35	D: 2.7		Wt: 1.65	
OUT OF CARTON:			H: 34.75	W: 34	D: 21.5		

7770	PREMIUM GRILL COVER		\$54.99	\$64.99	 0 77924 19404 7		
	<ul style="list-style-type: none"> Weather-resistant fabric shields your grill from rain and snow Made from durable, polyester material Lightweight design makes covering and uncovering easy Compatible with WEBER TRAVELER grill Fastening straps keep the cover secure once in place 	MASTER CARTON: 4					
		H: 11.7	W: 10.65	D: 8.15		Wt: 7.9	Cu.Ft.: 0.59
		INDIVIDUAL CARTON:					
		H: 11.2	W: 7.35	D: 2.7		Wt: 1.65	
OUT OF CARTON:			H: 39.3	W: 22.0	D: 56.6		

7030	CARGO PROTECTOR		\$61.49	\$71.49	 0 77924 16050 9		
	<ul style="list-style-type: none"> Form-fitted to the WEBER TRAVELER grill for optimal grease and grime containment Grease-resistant fabric protects trunk interior or cargo space Integrated storage pockets for grilling tools Folds flat and small for compact storage 	MASTER CARTON: 4					
		H: 20.99	W: 8.04	D: 12.41		Wt: 6.99	Cu.Ft.: 1.21
		INDIVIDUAL CARTON:					
		H: 10.0	W: 7.3	D: 2.7		Wt: 1.6	
OUT OF CARTON:			H: 13.81	W: 40.55	D: 23.0		

CARE: COVERS - GRIDDLES



<p>3400119 PREMIUM GRIDDLE COVER</p> 	<ul style="list-style-type: none"> Weather-resistant fabric helps shield your griddle from the elements Made from durable material Removes easily with built-in loops and a lightweight design Covers with side table up or folded down Fastening straps help keep the cover secure once in place Compatible with Slate™ 30" Rust-Resistant Griddle 	<p>\$99.99 \$109.99</p> <p>MASTER CARTON: 2</p> <p>H: 10.65 W: 9 D: 8.15 Wt: 5.5 Cu.Ft.: 0.51</p> <p>INDIVIDUAL CARTON:</p> <p>H: 11.1 W: 7.3 D: 4 Wt: 2.45</p> <p>OUT OF CARTON:</p> <p>H: 35.6 W: 66.5 D: 25</p>	 <p>0 77924 99199 8</p>
<p>3400120 PREMIUM GRIDDLE COVER</p> 	<ul style="list-style-type: none"> Weather-resistant fabric helps shield your griddle from the elements Made from durable material Removes easily with built-in loops and a lightweight design Covers with side table up or folded down Fastening straps help keep the cover secure once in place Compatible with Slate™ 36" Rust-Resistant Griddle 	<p>\$109.99 \$119.99</p> <p>MASTER CARTON: 2</p> <p>H: 10.35 W: 9 D: 7.85 Wt: 5.5 Cu.Ft.: 0.43</p> <p>INDIVIDUAL CARTON:</p> <p>H: 11.1 W: 7.3 D: 4 Wt: 2.45</p> <p>OUT OF CARTON:</p> <p>H: 35.5 W: 70 D: 28.8</p>	 <p>0 77924 99200 1</p>
<p>3400121 PREMIUM GRIDDLE COVER</p> 	<ul style="list-style-type: none"> Weather-resistant fabric shields your griddle from the elements Made from durable material Lightweight design makes covering and uncovering easy Fastening straps help keep the cover secure once in place Compatible with Weber Traveler® 17" Portable Griddle 	<p>\$34.99 \$39.99</p> <p>MASTER CARTON: 4</p> <p>H: 9.5 W: 10.95 D: 4.65 Wt: 7.75 Cu.Ft.: 7.5</p> <p>INDIVIDUAL CARTON:</p> <p>H: 7.45 W: 3.95 D: 2.45 Wt: 1.75</p> <p>OUT OF CARTON:</p> <p>H: 9 W: 21.8 D: 24.8</p>	 <p>0 77924 99201 8</p>
<p>3400122 PREMIUM GRIDDLE COVER</p> 	<ul style="list-style-type: none"> Weather-resistant fabric shields your griddle from the elements Made from durable material Lightweight design makes covering and uncovering easy Compatible with Weber Traveler® 17" and 22" Portable Griddles with expandable stand Fastening straps help keep the cover secure once in place 	<p>\$59.99 \$69.99</p> <p>MASTER CARTON: 2</p> <p>H: 10.65 W: 9 D: 8.15 Wt: 5.5 Cu.Ft.: 0.45</p> <p>INDIVIDUAL CARTON:</p> <p>H: 11.1 W: 7.3 D: 4 Wt: 2.45</p> <p>OUT OF CARTON:</p> <p>H: 34.5 W: 62 D: 25</p>	 <p>0 77924 99202 5</p>
<p>3400201 PREMIUM GRIDDLE COVER</p> 	<ul style="list-style-type: none"> Weather-resistant fabric shields your griddle from the elements Made from durable material Lightweight design makes covering and uncovering easy Fastening straps help keep the cover secure once in place Compatible with Weber Traveler® 22" Portable Griddle 	<p>\$39.99 \$44.99</p> <p>MASTER CARTON: 4</p> <p>H: 9.5 W: 10.95 D: 4.65 Wt: 7.75 Cu.Ft.: 7.5</p> <p>INDIVIDUAL CARTON:</p> <p>H: 7.45 W: 3.95 D: 2.45 Wt: 1.75</p> <p>OUT OF CARTON:</p> <p>H: 9 W: 30.5 D: 21.1</p>	 <p>0 77924 99616 0</p>
<p>7035 GRIDDLE STORAGE BAG 3B</p> 	<ul style="list-style-type: none"> Weather-resistant fabric shields your full-size griddle from the elements Made from durable material Lightweight design and double zipper make inserting and removing the full-size griddle easy Compatible with the SPIRIT or GENESIS Full-Size Griddle – 300 Series 	<p>\$49.99 \$54.99</p> <p>MASTER CARTON: 3</p> <p>H: 10.65 W: 8.15 D: 11.7 Wt: 5.3 Cu.Ft.: 0.58</p> <p>INDIVIDUAL CARTON:</p> <p>H: 10.1 W: 7.25 D: 2.65 Wt: 1.32</p> <p>OUT OF CARTON:</p> <p>H: 19.0 W: 27.0 D: 2.0</p>	 <p>0 77924 19938 7</p>



ACCESSORIES



MAP

MSRP



CARE: COVERS - GRIDDLES



7036	GRIDDLE STORAGE BAG 4B		\$59.99	\$69.99	 0 77924 19939 4				
 <ul style="list-style-type: none"> Weather-resistant fabric shields your full-size griddle from the elements Made from durable material Lightweight design and double zipper make inserting and removing the full-size griddle easy Compatible with the SPiRiT or GENESIS Full-Size Griddle – 400 Series 	MASTER CARTON: 3		H: 10.65	W: 8.15		D: 11.7	Wt: 5.3	Cu.Ft.: 0.58	
	INDIVIDUAL CARTON:		H: 10.1	W: 7.25		D: 2.65	Wt: 1.32		
	OUT OF CARTON:		H: 19.0	W: 34.0		D: 2.0			

7771	PREMIUM GRIDDLE COVER		\$99.99	\$109.99	 0 77924 19664 5				
 <ul style="list-style-type: none"> Weather-resistant fabric shields your grill from the elements. Made from durable material Lightweight design makes covering and uncovering easy Compatible with the WEBER GRIDDLE 28" Fastening straps keep the cover secure once in place 	MASTER CARTON: 3		H: 10.65	W: 8.15		D: 11.7	Wt: 5.3	Cu.Ft.: 0.59	
	INDIVIDUAL CARTON:		H: 11.2	W: 7.35		D: 2.7	Wt: 1.0		
	OUT OF CARTON:		H: 43.4	W: 63.0		D: 25.6			













3400030	PREMIUM GRIDDLE COVER		\$109.99	\$119.99	 0 77924 98956 8				
 <ul style="list-style-type: none"> Weather-resistant fabric shields your grill from the elements. Made from durable material Lightweight design makes covering and uncovering easy Compatible with the WEBER GRIDDLE 36" Fastening straps keep the cover secure once in place 	MASTER CARTON: 2		H: 10.5	W: 8.9		D: 8.0	Wt: 6.2	Cu.Ft.:	
	INDIVIDUAL CARTON:		H: 9.55	W: 7.25		D: 3.94	Wt: 2.53		
	OUT OF CARTON:		H: 43.4	W: 71.0		D: 27.0			

CARE: COVERS - PELLET

3400145	PREMIUM GRILL COVER		\$74.99	\$84.99	 0 77924 99292 6				
 <ul style="list-style-type: none"> Made from 100% recycled PET plastic material (excludes fasteners) UV inhibitors in fabric resist fading Breathable, weather resistant material helps protect grill from the elements Fastening straps help keep the cover in place Fits SEARWOOD 600 pellet grill 	MASTER CARTON: 2		H: 10.63	W: 9		D: 8.13	Wt: 6.63	Cu.Ft.: 0.45	
	INDIVIDUAL CARTON:		H: 10.07	W: 7.30		D: 4	Wt: 3		
	OUT OF CARTON:		H: 47	W: 38.5		D: 22.5			

3400146	PREMIUM GRILL COVER		\$94.99	\$104.99	 0 77924 99293 3				
 <ul style="list-style-type: none"> Made from 100% recycled PET plastic material (excludes fasteners) UV inhibitors in fabric resist fading Breathable, weather resistant material helps protect grill from the elements Fastening straps help keep the cover in place Fits SEARWOOD XL 600 pellet grill 	MASTER CARTON: 2		H: 10.63	W: 9		D: 8.13	Wt: 6.63	Cu.Ft.: 0.45	
	INDIVIDUAL CARTON:		H: 10.07	W: 7.30		D: 4	Wt: 3		
	OUT OF CARTON:		H: 47	W: 50.5		D: 22.5			

CARE: COVERS - GAS













7110	GRILL COVER	 <ul style="list-style-type: none"> • UV inhibitors in fabric resist fading • Breathable and water resistant to help protect grill from the elements • Drawstring keeps the cover in place • Fits WEBER Q 100/1000 series grills 	<p>\$21.99 \$24.99</p> <p>MASTER CARTON: 4 H: 4.63 W: 10.94 D: 9.5 Wt: 2.43 Cu.Ft.: 0.27</p> <p>INDIVIDUAL CARTON: H: 7.5 W: 3.94 D: 2.5 Wt: 0.45</p> <p>OUT OF CARTON: H: 12.4 W: 26.3 D: 17.3</p>	 0 77924 03545 6
3400232	PREMIUM GRILL COVER	 <ul style="list-style-type: none"> • Resists fading with UV-inhibiting fabric • Shields your grill with weather-resistant material • Secures in place with 2 drawstring pulls • Easy to cover and uncover thanks to a lightweight design • Fits Q 2800N+ gas grill • Made from 100% recycled PET plastic material (excludes fasteners) 	<p>\$29.99 \$34.99</p> <p>MASTER CARTON: 4 H: 9.50 W: 4.63 D: 10.94 Wt: 2.08 Cu.Ft.: 0.28</p> <p>INDIVIDUAL CARTON: H: 7.50 W: 3.94 D: 2.50 Wt: 0.52</p> <p>OUT OF CARTON: H: 16.7 W: 30 D: 19.7</p>	 0 77924 99763 1
3400233	PREMIUM GRILL COVER	 <ul style="list-style-type: none"> • Weather-resistant fabric helps shield your grill from the elements • Made from durable material • Lightweight design makes covering and uncovering easy • Fits Q 2800N+ gas grill with cart • Fastening straps help keep the cover secure once in place • Made from 100% recycled PET plastic material (excludes fasteners) 	<p>\$59.99 \$69.99</p> <p>MASTER CARTON: 4 H: 9.75 W: 13.5 D: 7.38 Wt: 8.6 Cu.Ft.: 0.56</p> <p>INDIVIDUAL CARTON: H: 10.43 W: 6.63 D: 2.44 Wt: 1.72</p> <p>OUT OF CARTON: H: 42.8 W: 30 D: 19.7</p>	 0 77924 99764 8
7137	TANK COVER	 <ul style="list-style-type: none"> • UV inhibitors in fabric resists fading • Breathable, weather resistant fabric • Protects cylinder from the elements • Drawstring keeps the cover in place • Fits standard size 20 lb. LP tank (tank sold separately) 	<p>\$14.49 \$17.49</p> <p>MASTER CARTON: 4 H: 9.5 W: 10.9 D: 4.6 Wt: 2.25 Cu.Ft.: 0.3</p> <p>INDIVIDUAL CARTON: H: 8.75 W: 4.0 D: 2.5 Wt: 0.4</p> <p>OUT OF CARTON: H: 16.5 W: 13.9 D: 13.9</p>	 0 77924 05199 9
7138	PREMIUM GRILL COVER	 <ul style="list-style-type: none"> • UV inhibitors in fabric resist fading • Breathable and water resistant to help protect grill from the elements • Fastening straps keep the cover in place • Fits SPIRIT 200 and SPIRIT II 200 series gas grills 	<p>\$78.49 \$88.49</p> <p>MASTER CARTON: 3 H: 10.63 W: 8.13 D: 13.13 Wt: 6.83 Cu.Ft.: 0.65</p> <p>INDIVIDUAL CARTON: H: 11.25 W: 7.25 D: 4.0 Wt: 2.18</p> <p>OUT OF CARTON: H: 42.0 W: 48.0 D: 27.0</p>	 0 77924 05874 5
7139	PREMIUM GRILL COVER	 <ul style="list-style-type: none"> • UV inhibitors in fabric resist fading • Breathable and water resistant to help protect grill from the elements • Fastening straps keep the cover in place • Fits SPIRIT 300 and SPIRIT II 300 series gas grills 	<p>\$89.49 \$99.49</p> <p>MASTER CARTON: 3 H: 10.63 W: 8.07 D: 13.13 Wt: 9.09 Cu.Ft.: 0.65</p> <p>INDIVIDUAL CARTON: H: 11.25 W: 7.25 D: 4.0 Wt: 2.3</p> <p>OUT OF CARTON: H: 42.0 W: 52.0 D: 27.0</p>	 0 77924 05875 2

ACCESSORIES

MAP

MSRP

CARE: COVERS - GAS

7757	PREMIUM GRILL COVER	\$100.99	\$110.99		
	<ul style="list-style-type: none"> • UV inhibitors in fabric resist fading • Breathable and water resistant to help protect grill from the elements • Fastening straps keep the cover in place • Fits GENESIS 300 series gas grills, and GENESIS II 300 series gas grills 	MASTER CARTON: 2			
		H: 10.6 W: 8.1 D: 9.0 Wt: 6.5 Cu.Ft.: 0.5			
		INDIVIDUAL CARTON:			
		H: 10.1 W: 7.3 D: 4.0 Wt: 2.9			
OUT OF CARTON:		H: 43.4 W: 63 D: 25.6			
7758	PREMIUM GRILL COVER	\$106.49	\$116.49		
	<ul style="list-style-type: none"> • UV inhibitors in fabric resist fading • Breathable and water resistant to help protect grill from the elements • Fastening straps keep the cover in place • Fits GENESIS II 400 series gas grills, and GENESIS 400 series gas grills 	MASTER CARTON: 2			
		H: 10.6 W: 8.1 D: 9.0 Wt: 7.1 Cu.Ft.: 0.5			
		INDIVIDUAL CARTON:			
		H: 10.1 W: 7.3 D: 4.0 Wt: 3.2			
OUT OF CARTON:		H: 43.4 W: 70.8 D: 25.6			
207138	PREMIUM GRILL COVER - 8 PACK	\$78.49	\$88.49		
	<ul style="list-style-type: none"> • UV inhibitors in fabric resist fading • Breathable and water resistant to help protect grill from the elements • Fastening straps keep the cover in place • Fits SPIRIT 200 and SPIRIT II 200 series gas grills 	MASTER CARTON: 8			
		H: 27.5 W: 8.13 D: 17.3 Wt: 22.0 Cu.Ft.: 2.2			
		INDIVIDUAL CARTON:			
		H: 11.25 W: 7.25 D: 4.0 Wt: 2.18			
OUT OF CARTON:		H: 42.0 W: 48.0 D: 27.0			
207139	PREMIUM GRILL COVER - 8 PACK	\$89.49	\$99.49		
	<ul style="list-style-type: none"> • UV inhibitors in fabric resist fading • Breathable and water resistant to help protect grill from the elements • Fastening straps keep the cover in place • Fits SPIRIT 300 and SPIRIT II 300 series gas grills 	MASTER CARTON: 8			
		H: 27.5 W: 8.1 D: 17.3 Wt: 22.6 Cu.Ft.: 2.2			
		INDIVIDUAL CARTON:			
		H: 11.25 W: 7.25 D: 4.0 Wt: 2.3			
OUT OF CARTON:		H: 42.0 W: 52.0 D: 27.0			
7754	PREMIUM GRILL COVER - 8 PACK	\$100.99	\$110.99		
	<ul style="list-style-type: none"> • UV inhibitors in fabric resist fading • Breathable and water resistant to help protect grill from the elements • Fastening straps keep the cover in place • Fits GENESIS 300 series gas grills, and GENESIS II 300 series gas grills 	MASTER CARTON: 8			
		H: 8.3 W: 17.3 D: 27.5 Wt: 26.7 Cu.Ft.: 2.3			
		INDIVIDUAL CARTON:			
		H: 10.1 W: 7.3 D: 4.0 Wt: 2.9			
OUT OF CARTON:		H: 43.4 W: 63 D: 25.6			
7755	PREMIUM GRILL COVER - 8 PACK	\$106.49	\$116.49		
	<ul style="list-style-type: none"> • UV inhibitors in fabric resist fading • Breathable and water resistant to help protect grill from the elements • Fastening straps keep the cover in place • Fits GENESIS II 400 series gas grills, and GENESIS 400 series gas grills 	MASTER CARTON: 8			
		H: 17.3 W: 28.8 D: 28.8 Wt: 28.8 Cu.Ft.: 2.4			
		INDIVIDUAL CARTON:			
		H: 10.1 W: 7.3 D: 4.0 Wt: 3.2			
OUT OF CARTON:		H: 43.4 W: 70.8 D: 25.6			

CARE: COVERS - CHARCOAL









7154	SMOKEY JOE BAG	 <ul style="list-style-type: none"> • Comes with an adjustable, padded shoulder strap • Fits SMOKEY JOE and SMOKEY JOE Premium portable grills 	<p>\$29.99 \$34.99</p> <p>MASTER CARTON: 2</p> <p>H: 9.94 W: 8.68 D: 5.19 Wt: 2.15 Cu.Ft.: 0.25</p> <p>INDIVIDUAL CARTON:</p> <p>H: 9.13 W: 8.0 D: 2.25 Wt: 0.92</p> <p>OUT OF CARTON:</p> <p>H: 19.6 W: 18.9 D: 16.5</p>	 <p>0 77924 03549 4</p>
7175	GRILL COVER	 <ul style="list-style-type: none"> • Breathable and water resistant to help protect grill from rusting • Fastening strap keeps the cover in place • Fits 18 inch WEBER charcoal grills 	<p>\$19.49 \$22.49</p> <p>MASTER CARTON: 5</p> <p>H: 9.88 W: 7.44 D: 8.88 Wt: 5.0 Cu.Ft.: 0.37</p> <p>INDIVIDUAL CARTON:</p> <p>H: 9.07 W: 6.63 D: 1.5 Wt: 0.6</p> <p>OUT OF CARTON:</p> <p>H: 32.0 W: 18.5 D: 24.0</p>	 <p>0 77924 04814 2</p>
7176	GRILL COVER	 <ul style="list-style-type: none"> • Breathable and water resistant to help protect grill from rusting • Fastening strap keeps the cover in place • Fits 22 inch WEBER charcoal grills 	<p>\$21.99 \$24.99</p> <p>MASTER CARTON: 5</p> <p>H: 9.88 W: 7.44 D: 8.88 Wt: 6.0 Cu.Ft.: 0.37</p> <p>INDIVIDUAL CARTON:</p> <p>H: 9.07 W: 6.63 D: 1.5 Wt: 0.8</p> <p>OUT OF CARTON:</p> <p>H: 35.0 W: 23.5 D: 28.5</p>	 <p>0 77924 04815 9</p>
7148	PREMIUM GRILL COVER	 <ul style="list-style-type: none"> • UV inhibitors in fabric resist fading • Breathable and water resistant to help protect grill from the elements • Fastening strap keeps the cover in place • Fits 18 inch WEBER charcoal grills 	<p>\$38.99 \$43.99</p> <p>MASTER CARTON: 4</p> <p>H: 10.63 W: 8.13 D: 9.0 Wt: 4.7 Cu.Ft.: 0.45</p> <p>INDIVIDUAL CARTON:</p> <p>H: 9.75 W: 7.25 D: 1.94 Wt: 0.92</p> <p>OUT OF CARTON:</p> <p>H: 32.5 W: 20.0 D: 20.5</p>	 <p>0 77924 03272 1</p>
7150	PREMIUM GRILL COVER	 <ul style="list-style-type: none"> • UV inhibitors in fabric resist fading • Breathable and water resistant to help protect grill from the elements • Fastening strap keeps the cover in place • Fits 22 inch WEBER charcoal grills 	<p>\$45.99 \$50.99</p> <p>MASTER CARTON: 4</p> <p>H: 10.63 W: 8.13 D: 11.69 Wt: 6.08 Cu.Ft.: 0.58</p> <p>INDIVIDUAL CARTON:</p> <p>H: 9.75 W: 7.25 D: 2.63 Wt: 1.16</p> <p>OUT OF CARTON:</p> <p>H: 35.0 W: 27.0 D: 25.0</p>	 <p>0 77924 03278 3</p>
7151	PREMIUM GRILL COVER	 <ul style="list-style-type: none"> • UV inhibitors in fabric resist fading • Breathable and water resistant to help protect grill from the elements • Fastening strap keeps the cover in place • Fits PERFORMER 22 inch charcoal grills with folding table 	<p>\$55.99 \$65.99</p> <p>MASTER CARTON: 3</p> <p>H: 10.63 W: 8.13 D: 9.0 Wt: 5.54 Cu.Ft.: 0.45</p> <p>INDIVIDUAL CARTON:</p> <p>H: 11.25 W: 7.25 D: 2.75 Wt: 1.52</p> <p>OUT OF CARTON:</p> <p>H: 42.0 W: 40.0 D: 33.0</p>	 <p>0 77924 03280 6</p>

ACCESSORIES











MAP

MSRP

CARE: COVERS - CHARCOAL

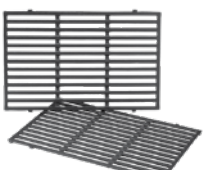
7152	PREMIUM GRILL COVER	\$72.99	\$82.99	 0 77924 03281 3
	<ul style="list-style-type: none"> • UV inhibitors in fabric resist fading • Breathable and water resistant to help protect grill from the elements • Fastening strap keeps the cover in place • Fits PERFORMER Premium and Deluxe 22 inch charcoal grills 	MASTER CARTON: 3		
		H: 10.63 W: 8.13 D: 9.0 Wt: 6.2 Cu.Ft.: 0.45		
		INDIVIDUAL CARTON:		
		H: 11.25 W: 7.25 D: 2.65 Wt: 1.68		
OUT OF CARTON:		H: 46.7 W: 48.5 D: 39.8		
7153	PREMIUM GRILL COVER	\$55.99	\$65.99	 0 77924 03283 7
	<ul style="list-style-type: none"> • UV inhibitors in fabric resist fading • Breathable and water resistant to help protect grill from the elements • Fastening strap keeps the cover in place • Fits 26 inch WEBER charcoal grills 	MASTER CARTON: 2		
		H: 10.63 W: 8.13 D: 6.26 Wt: 3.92 Cu.Ft.: 0.31		
		INDIVIDUAL CARTON:		
		H: 11.25 W: 7.25 D: 2.65 Wt: 1.3		
OUT OF CARTON:		H: 39.0 W: 31.5 D: 31.5		
7173	PREMIUM GRILL COVER	\$87.49	\$97.49	 0 77924 04165 5
	<ul style="list-style-type: none"> • UV inhibitors in fabric resist fading • Breathable and water resistant to help protect grill from the elements • Fastening strap keeps the cover in place • Fits SUMMIT Kamado E6 grill and SUMMIT charcoal grill 	MASTER CARTON: 2		
		H: 10.63 W: 8.13 D: 6.26 Wt: 4.21 Cu.Ft.: 0.31		
		INDIVIDUAL CARTON:		
		H: 11.25 W: 7.25 D: 2.65 Wt: 1.69		
OUT OF CARTON:		H: 43.0 W: 35.8 D: 34.0		
7174	PREMIUM GRILL COVER	\$100.99	\$110.99	 0 77924 04175 4
	<ul style="list-style-type: none"> • UV inhibitors in fabric resist fading • Breathable and water resistant to help protect grill from the elements • Fastening strap keeps the cover in place • Fits SUMMIT Kamado S6 Grill Center and SUMMIT Grill Center charcoal grill 	MASTER CARTON: 2		
		H: 10.63 W: 8.13 D: 9.0 Wt: 6.08 Cu.Ft.: 0.45		
		INDIVIDUAL CARTON:		
		H: 11.25 W: 7.25 D: 4.0 Wt: 2.19		
OUT OF CARTON:		H: 44.5 W: 53.0 D: 36.0		

CARE: REPLACEMENT PARTS - GAS



6414	REPLACEMENT CASTER	 <ul style="list-style-type: none"> Fits the following grills: • GENESIS 1000-5000 • GENESIS A/B/C (2002-2003 model years) • GENESIS Gold B/C (model year 2002 and newer) • Platinum I • RANCH kettle • PERFORMER (prior to 2005 model year) 	<p>\$10.99 \$13.99</p> <p>MASTER CARTON: 6</p> <p>H: 6.94 W: 6.44 D: 9.57 Wt: 1.98 Cu.Ft.: 0.24</p> <p>INDIVIDUAL CARTON:</p> <p>H: 6.1 W: 2.75 D: 2.75 Wt: 0.33</p> <p>OUT OF CARTON:</p> <p>H: 2.5 W: 1.5 D: 4.6</p>	 <p>0 77924 07474 5</p>
6501	WEBER Q ADAPTER HOSE	 <ul style="list-style-type: none"> • Connects to a Type I (791) cylinder connection on a 20 lb. LP tank • Fits Baby Q gas grill, WEBER Q 100/1000 series grills, WEBER Q gas grill, WEBER Q 200/2000 series grills, GO-ANYWHERE gas grills, WEBER TRAVELER gas grill, and WEBER SLATE Tabletop Griddle 	<p>\$43.99 \$48.99</p> <p>MASTER CARTON: 4</p> <p>H: 10.32 W: 8.44 D: 13.5 Wt: 6.0 Cu.Ft.: 0.68</p> <p>INDIVIDUAL CARTON:</p> <p>H: 9.25 W: 7.5 D: 3.0 Wt: 1.5</p> <p>OUT OF CARTON:</p> <p>H: 6.8 W: 1.5 D: 0.5</p>	 <p>0 77924 07501 8</p>
7644	COOKING GRATES	 <ul style="list-style-type: none"> • Porcelain-enameled, cast-iron cooking grates • Includes bracket support for WEBER Q 100 series gas grills • Fits WEBER Q 100/1000 series gas grills 	<p>\$85.99 \$95.99</p> <p>MASTER CARTON: 1</p> <p>H: 1.25 W: 20.88 D: 16.0 Wt: 11.3 Cu.Ft.: 0.24</p> <p>INDIVIDUAL CARTON:</p> <p>H: 16.0 W: 20.88 D: 1.25 Wt: 11.3</p> <p>OUT OF CARTON:</p> <p>H: 17.0 W: 12.7 D: 0.5</p>	 <p>0 77924 03883 9</p>
7524	GAS GRILL COOKING GRATES	 <ul style="list-style-type: none"> • Porcelain-enameled, cast-iron cooking grates • Fits GENESIS 300 series gas grills • Does not fit GENESIS II 300 series gas grills 	<p>\$135.99 \$145.99</p> <p>MASTER CARTON: 1</p> <p>H: 2.38 W: 23.07 D: 16.63 Wt: 17.3 Cu.Ft.: 0.52</p> <p>INDIVIDUAL CARTON:</p> <p>H: 16.63 W: 23.07 D: 2.38 Wt: 17.3</p> <p>OUT OF CARTON:</p> <p>H: 19.5 W: 12.9 D: 0.5</p>	 <p>0 77924 07437 0</p>
7639	GAS GRILL COOKING GRATES	 <ul style="list-style-type: none"> • Stainless steel cooking grates • Fits SPIRIT 300 series gas grills • Does not fit SPIRIT II 300 series gas grills 	<p>\$135.49 \$145.49</p> <p>MASTER CARTON: 1</p> <p>H: 1.38 W: 20.25 D: 14.07 Wt: 11.12 Cu.Ft.: 0.22</p> <p>INDIVIDUAL CARTON:</p> <p>H: 14.07 W: 20.25 D: 1.38 Wt: 11.12</p> <p>OUT OF CARTON:</p> <p>H: 17.3 W: 11.8 D: 0.5</p>	 <p>0 77924 03222 6</p>

ACCESSORIES

MAP

MSRP



CARE: REPLACEMENT PARTS - GAS

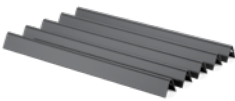

7528	GAS GRILL COOKING GRATES		\$184.99	\$204.99	 0 77924 07441 7		
	<ul style="list-style-type: none"> Stainless steel cooking grates Fits GENESIS 300 series gas grills Does not fit GENESIS II 300 series gas grills 	MASTER CARTON: 1					
		H: 2.0	W: 22.11	D: 16.07		Wt: 14.1	Cu.Ft.: 0.41
		INDIVIDUAL CARTON:					
		H: 16.07	W: 22.11	D: 2.0	Wt: 14.1		
		OUT OF CARTON:					
		H: 19.5	W: 12.9	D: 0.6			

7534	FLAVORIZER BARS		\$65.99	\$75.99	 0 77924 07447 9		
	<ul style="list-style-type: none"> Porcelain-enameled Catch drippings that smoke and sizzle, adding a smoky flavor to food Set of five bars Fits SPIRIT 200 series (with side-mounted control panel), SPIRIT 500, and GENESIS Silver A 	MASTER CARTON: 1					
		H: 3.25	W: 25.5	D: 5.5		Wt: 6.5	Cu.Ft.: 0.26
		INDIVIDUAL CARTON:					
		H: 5.5	W: 25.5	D: 3.25	Wt: 6.5		
		OUT OF CARTON:					
		H: 21.5	W: 1.7	D: 1.7			











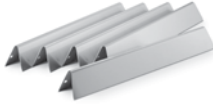

3400301	FLAVORIZER BARS		\$49.99	\$54.99	 0 77924 99951 2		
<p>Image coming soon</p>	<p>Details coming soon</p>	MASTER CARTON: 1					
		H: 5.8	W: 5	D: 17.5		Wt: 3.3	Cu.Ft.: 0.3
		INDIVIDUAL CARTON:					
		H: 5.8	W: 5	D: 17.5	Wt:		
		OUT OF CARTON:					
		H:	W:	D:			

3400302	FLAVORIZER BARS		\$64.99	\$74.99	 0 77924 99952 9		
<p>Image coming soon</p>	<p>Details coming soon</p>	MASTER CARTON: 1					
		H: 5.8	W: 5	D: 17.5		Wt: 3.3	Cu.Ft.: 0.3
		INDIVIDUAL CARTON:					
		H: 5.8	W: 5	D: 17.5	Wt:		
		OUT OF CARTON:					
		H:	W:	D:			

7536	FLAVORIZER BARS		\$65.99	\$75.99	 0 77924 07449 3		
	<ul style="list-style-type: none"> Porcelain-enameled Catch drippings that smoke and sizzle, adding a smoky flavor to food Set of five bars Fits SPIRIT 300 series gas grills (with side-mounted control panel) 	MASTER CARTON: 1					
		H: 3.25	W: 25.5	D: 5.5		Wt: 8.3	Cu.Ft.: 0.26
		INDIVIDUAL CARTON:					
		H: 5.5	W: 25.5	D: 3.25	Wt: 8.3		
		OUT OF CARTON:					
		H: 22.5	W: 2.3	D: 2.3			

7540	FLAVORIZER® BARS		\$156.99	\$176.99	 0 77924 07453 0		
	<ul style="list-style-type: none"> Catch drippings that smoke and sizzle, adding a smoky flavor to food Set of 5 Fits Genesis® 300 series gas grills (side-mounted control panel) 	MASTER CARTON: 1					
		L: 26	W: 6.5	H: 3.5		Wt: 9	Cu.Ft.: 0.3
		INDIVIDUAL CARTON:					
		L: 26	W: 6.5	H: 3.5	Wt: 9		
		OUT OF CARTON:					
		L: 24.5	W: 2.3	H: 2.3			

CARE: REPLACEMENT PARTS - GAS











7620	FLAVORIZER BARS	 <ul style="list-style-type: none"> • Stainless steel • Catch drippings that smoke and sizzle, adding a smoky flavor to food • Set of five bars • Fits GENESIS 300 series gas grills (with front-mounted control panel) 	<p>\$143.99 \$153.99</p> <p>MASTER CARTON: 1 H: 3.44 W: 25.63 D: 5.88 Wt: 4.5 Cu.Ft.: 0.3</p> <p>INDIVIDUAL CARTON: H: 5.88 W: 25.63 D: 3.44 Wt: 4.5</p> <p>OUT OF CARTON: H: 17.5 W: 2.2 D: 2.3</p>	 <p>0 77924 02316 3</p>
7502	21 INCH HOSE AND REGULATOR KIT	 <p>Fits</p> <ul style="list-style-type: none"> • GENESIS Silver C • GENESIS Gold B/C • GENESIS Platinum B/C • SUMMIT Silver/Gold/Platinum 	<p>\$45.99 \$50.99</p> <p>MASTER CARTON: 4 H: 10.32 W: 8.44 D: 13.57 Wt: 6.0 Cu.Ft.: 0.68</p> <p>INDIVIDUAL CARTON: H: 9.25 W: 7.6 D: 3.1 Wt: 1.42</p> <p>OUT OF CARTON: H: 21.0 W: 4.0 D: 0.5</p>	 <p>0 77924 07415 8</p>
7627	30 INCH HOSE AND REGULATOR KIT	 <ul style="list-style-type: none"> • Fits GENESIS 300 series gas grills (front mounted control panel) • Fits SUMMIT 400/600 series gas grills 	<p>\$45.99 \$50.99</p> <p>MASTER CARTON: 4 H: 10.32 W: 8.44 D: 13.57 Wt: 6.54 Cu.Ft.: 0.68</p> <p>INDIVIDUAL CARTON: H: 9.29 W: 7.54 D: 3.04 Wt: 1.64</p> <p>OUT OF CARTON: H: 31.2 W: 4.0 D: 0.6</p>	 <p>0 77924 02328 6</p>
7507	STAINLESS STEEL BURNER TUBE SET	 <p>Fits the following gas grills:</p> <ul style="list-style-type: none"> • SPIRIT 500 • GENESIS Silver A 	<p>\$58.99 \$68.99</p> <p>MASTER CARTON: 4 H: 5.44 W: 31.75 D: 6.69 Wt: 12.31 Cu.Ft.: 0.66</p> <p>INDIVIDUAL CARTON: H: 2.9 W: 30.1 D: 2.3 Wt: 2.5</p> <p>OUT OF CARTON: H: 27.0 W: 1.0 D: 1.0</p>	 <p>0 77924 07420 2</p>
7508	STAINLESS STEEL BURNER TUBE SET	 <p>Fits the following gas grills:</p> <ul style="list-style-type: none"> • SPIRIT 700 • GENESIS Silver B/C • GENESIS Gold (2002 and newer models) 	<p>\$71.99 \$81.99</p> <p>MASTER CARTON: 4 H: 5.44 W: 31.75 D: 6.69 Wt: 13.2 Cu.Ft.: 0.66</p> <p>INDIVIDUAL CARTON: H: 2.9 W: 30.1 D: 2.3 Wt: 3.3</p> <p>OUT OF CARTON: H: 28.0 W: 1.0 D: 1.0</p>	 <p>0 77924 07421 9</p>
7509	IGNITER KIT	 <p>Fits the following gas grills:</p> <ul style="list-style-type: none"> • SPIRIT (does not fit front-mounted control panel models) • GENESIS (prior to 2002 model year) • Platinum I/II 	<p>\$18.99 \$21.99</p> <p>MASTER CARTON: 6 H: 6.94 W: 6.44 D: 9.57 Wt: 1.10 Cu.Ft.: 0.24</p> <p>INDIVIDUAL CARTON: H: 6.10 W: 2.75 D: 2.75 Wt: 0.35</p> <p>OUT OF CARTON: H: 19.1 W: 1 D: 1</p>	 <p>0 77924 07422 6</p>

ACCESSORIES



MAP

MSRP

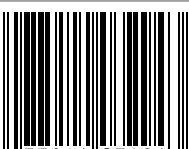

CARE: REPLACEMENT PARTS - GAS



<p>7510 IGNITER KIT</p> 	<p>Fits the following gas grills:</p> <ul style="list-style-type: none"> • GENESIS Silver/Gold/Platinum 2002 and newer (does not fit GENESIS Silver/Gold C models after 2003) 	<p>\$18.99 \$21.99</p> <p>MASTER CARTON: 6 H: 6.94 W: 6.44 D: 9.57 Wt: 2.04 Cu.Ft.: 0.24</p> <p>INDIVIDUAL CARTON: H: 6.1 W: 2.75 D: 2.75 Wt: 0.34</p> <p>OUT OF CARTON: H: 7.5 W: 2.7 D: 2.7</p>	 <p>0 77924 07423 3</p>
<p>7628 IGNITER KIT</p> 	<ul style="list-style-type: none"> • Battery included • Fits GENESIS 310 and 320 gas grills (with front-mounted control panel) 	<p>\$52.99 \$62.99</p> <p>MASTER CARTON: 6 H: 8.88 W: 8.19 D: 9.44 Wt: 6.10 Cu.Ft.: 0.39</p> <p>INDIVIDUAL CARTON: H: 8.00 W: 3.63 D: 2.75 Wt: 0.87</p> <p>OUT OF CARTON: H: 3.3 W: 3.1 D: 2.4</p>	 <p>0 77924 02329 3</p>
<p>7629 IGNITER KIT</p> 	<ul style="list-style-type: none"> • Battery included • Fits GENESIS 330 gas grill (with front-mounted control panel) 	<p>\$52.99 \$62.99</p> <p>MASTER CARTON: 6 H: 8.88 W: 8.19 D: 9.44 Wt: 6.30 Cu.Ft.: 0.39</p> <p>INDIVIDUAL CARTON: H: 8.00 W: 3.63 D: 2.80 Wt: 0.90</p> <p>OUT OF CARTON: H: 3.2 W: 3.1 D: 2.3</p>	 <p>0 77924 02330 9</p>
<p>7642 IGNITER KIT</p> 	<ul style="list-style-type: none"> • Battery included • Fits SPIRIT 210 and SPIRIT 310 gas grills (with front-mounted control panel) 	<p>\$53.99 \$63.99</p> <p>MASTER CARTON: 6 H: 8.88 W: 8.19 D: 9.44 Wt: 5.22 Cu.Ft.: 0.39</p> <p>INDIVIDUAL CARTON: H: 8.0 W: 3.63 D: 2.8 Wt: 0.72</p> <p>OUT OF CARTON: H: 9.2 W: 3.6 D: 2.7</p>	 <p>0 77924 03223 3</p>
<p>7513 WARMING RACK</p> 	<p>Fits the following gas grills:</p> <ul style="list-style-type: none"> • SPIRIT 700 • GENESIS 1000-5500 • GENESIS Silver B/C • GENESIS Gold/Platinum • Platinum I/II 	<p>\$19.99 \$22.99</p> <p>MASTER CARTON: 4 H: 2.82 W: 26.0 D: 5.5 Wt: 7.0 Cu.Ft.: 0.23</p> <p>INDIVIDUAL CARTON: H: 4.75 W: 24.8 D: 0.63 Wt: 1.42</p> <p>OUT OF CARTON: H: 24.9 W: 4.7 D: 0.4</p>	 <p>0 77924 07426 4</p>
<p>7641 WARMING RACK</p> 	<ul style="list-style-type: none"> • Keeps food warm while food grills below • Fits SPIRIT 300 series gas grills 	<p>\$24.49 \$29.49</p> <p>MASTER CARTON: 4 H: 3.63 W: 26.25 D: 6.25 Wt: 6.32 Cu.Ft.: 0.34</p> <p>INDIVIDUAL CARTON: H: 0.75 W: 26.0 D: 6.0 Wt: 1.5</p> <p>OUT OF CARTON: H: 24.8 W: 4.6 D: 2.3</p>	 <p>0 77924 03294 3</p>



CARE: REPLACEMENT PARTS - GAS



7515	CATCH PAN AND HOLDER		\$33.99	\$38.99	 0 77924 07428 8	
	Fits the following gas grills: • SPIRIT (does not fit front-mounted control panel models) • GENESIS 1000-5500 • GENESIS Silver/Gold/Platinum • Platinum I/II • SUMMIT (except Gold/Platinum 6-burner)	MASTER CARTON: 4				
		H: 10.32	W: 8.44	D: 13.57		Wt: 8.0 Cu.Ft.: 0.68
		INDIVIDUAL CARTON:				
		H: 9.5	W: 7.6	D: 3.1		Wt: 2.0
		OUT OF CARTON:				
		H: 9.1	W: 7.3	D: 3.0		

CARE: REPLACEMENT PARTS - CHARCOAL

7439	CHARCOAL GRATE		\$11.99	\$14.99	 0 77924 07404 2	
	Fits 14 inch WEBER charcoal grills	MASTER CARTON: 5				
		H: 3.38	W: 11.86	D: 11.86		Wt: 5.0 Cu.Ft.: 0.26
		INDIVIDUAL CARTON:				
		H: 10.63	W: 10.63	D: 0.63	Wt: 1.0	
		OUT OF CARTON:				
		H: 10.5	W: 10.5	D: 0.3		

7440	CHARCOAL GRATE		\$14.99	\$17.99	 0 77924 07405 9	
	Fits 18 inch WEBER charcoal grills (does not fit SMOKEY MOUNTAIN COOKER smoker)	MASTER CARTON: 5				
		H: 3.38	W: 15.07	D: 15.07		Wt: 9.78 Cu.Ft.: 0.44
		INDIVIDUAL CARTON:				
		H: 13.63	W: 13.63	D: 0.63	Wt: 1.8	
		OUT OF CARTON:				
		H: 13.5	W: 13.5	D: 0.4		

7433	HINGED COOKING GRATE		\$24.99	\$29.99	 0 77924 07398 4	
	Fits 18 inch WEBER charcoal grills (does not fit SMOKEY MOUNTAIN COOKER smoker)	MASTER CARTON: 5				
		H: 3.38	W: 19.25	D: 19.5		Wt: 16.0 Cu.Ft.: 0.73
		INDIVIDUAL CARTON:				
		H: 17.5	W: 17.5	D: 2.25	Wt: 3.2	
		OUT OF CARTON:				
		H: 17.2	W: 17.5	D: 1.7		









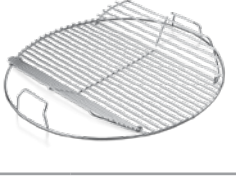

7435	CHARCOAL GRATE		\$25.99	\$30.99	 0 77924 07400 4	
	Fits 22 inch WEBER charcoal grills (does not fit SMOKEY MOUNTAIN COOKER smoker)	MASTER CARTON: 5				
		H: 3.38	W: 22.88	D: 22.88		Wt: 31.67 Cu.Ft.: 1.02
		INDIVIDUAL CARTON:				
		H: 21.5	W: 21.5	D: 2.25	Wt: 6.0	
		OUT OF CARTON:				
		H: 21.5	W: 21.5	D: 2.0		

ACCESSORIES

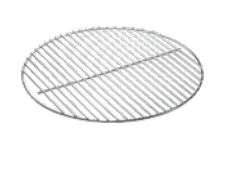





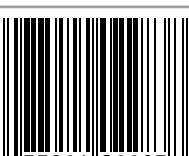



MAP

MSRP

CARE: REPLACEMENT PARTS - CHARCOAL

<p>7436 HINGED COOKING GRATE</p> 	<p>Fits 22 inch WEBER charcoal grills (does not fit SMOKEY MOUNTAIN COOKER smoker)</p>	<p>\$39.99 \$44.99</p> <p>MASTER CARTON: 5 H: 3.38 W: 22.88 D: 22.88 Wt: 26.22 Cu.Ft.: 1.02</p> <p>INDIVIDUAL CARTON: H: 21.5 W: 21.5 D: 1.75 Wt: 5.0</p> <p>OUT OF CARTON: H: 21.5 W: 21.5 D: 1.8</p>	 <p>0 77924 07401 1</p>
<p>7441 CHARCOAL GRATE</p> 	<p>Fits 22 inch WEBER charcoal grills (does not fit SMOKEY MOUNTAIN COOKER smoker)</p>	<p>\$19.99 \$22.99</p> <p>MASTER CARTON: 5 H: 3.38 W: 19.25 D: 19.5 Wt: 17.22 Cu.Ft.: 0.73</p> <p>INDIVIDUAL CARTON: H: 18.0 W: 18.0 D: 0.63 Wt: 3.2</p> <p>OUT OF CARTON: H: 17.0 W: 17.0 D: 0.4</p>	 <p>0 77924 07406 6</p>
<p>7431 CHARCOAL GRATE</p> 	<p>Fits 14 inch WEBER charcoal grills (does not fit SMOKEY MOUNTAIN COOKER smoker)</p>	<p>\$12.99 \$15.99</p> <p>MASTER CARTON: 5 H: 3.38 W: 15.07 D: 15.07 Wt: 8.3 Cu.Ft.: 0.44</p> <p>INDIVIDUAL CARTON: H: 13.63 W: 13.63 D: 0.36 Wt: 1.37</p> <p>OUT OF CARTON: H: 13.7 W: 13.7 D: 0.3</p>	 <p>0 77924 07396 0</p>
<p>7432 CHARCOAL GRATE</p> 	<p>Fits 18 inch WEBER charcoal grills (does not fit SMOKEY MOUNTAIN COOKER smoker)</p>	<p>\$23.99 \$26.99</p> <p>MASTER CARTON: 5 H: 3.38 W: 19.25 D: 19.5 Wt: 16.0 Cu.Ft.: 0.73</p> <p>INDIVIDUAL CARTON: H: 17.5 W: 17.5 D: 2.25 Wt: 3.2</p> <p>OUT OF CARTON: H: 17.5 W: 17.5 D: 2.0</p>	 <p>0 77924 07397 7</p>
<p>7444 22 INCH ONE-TOUCH CLEANING SYSTEM KIT</p> 	<ul style="list-style-type: none"> • Contains three damper blades, one damper control rod, one H-drive assembly, one washer, and an instruction sheet • Fits 22 inch ONE-TOUCH, 22 inch ORIGINAL KETTLE, and PERFORMER charcoal grills 	<p>\$24.99 \$29.99</p> <p>MASTER CARTON: 6 H: 10.94 W: 4.94 D: 9.44 Wt: 5.8 Cu.Ft.: 0.29</p> <p>INDIVIDUAL CARTON: H: 10.1 W: 4.5 D: 1.5 Wt: 0.95</p> <p>OUT OF CARTON: H: 9.2 W: 1.6 D: 0.8</p>	 <p>0 77924 01097 2</p>
<p>7478 KETTLE TOOL HOOK HANDLE</p> 	<ul style="list-style-type: none"> • Update your kettle with a new handle • Equipped with two tool hooks 	<p>\$13.49 \$16.49</p> <p>MASTER CARTON: 6 H: 6.51 W: 8.13 D: 13.44 Wt: 2.1 Cu.Ft.: 0.41</p> <p>INDIVIDUAL CARTON: H: 5.55 W: 7.2 D: 1.88 Wt: 0.35</p> <p>OUT OF CARTON: H: 0.6 W: 1.2 D: 1.4</p>	 <p>0 77924 02283 8</p>

MERCHANDISE: CARTS AND TABLES



3400262	COMPACT STAND	 <ul style="list-style-type: none"> • Lightweight, durable construction • Get quick access to grilling tools with built-in storage shelf • No tools needed to assemble • Compatible with all Weber® Q grills 	<table border="1"> <tr> <td colspan="5" style="text-align: right;">\$99.99</td> <td colspan="5" style="text-align: right;">\$109.99</td> </tr> <tr> <td colspan="10">MASTER CARTON: 1</td> </tr> <tr> <td>H:</td> <td>18.58</td> <td>W:</td> <td>24.96</td> <td>D:</td> <td>5.43</td> <td>Wt:</td> <td>18.8</td> <td>Cu.Ft.:</td> <td>1.46</td> </tr> <tr> <td colspan="10">INDIVIDUAL CARTON:</td> </tr> <tr> <td>H:</td> <td>18.58</td> <td>W:</td> <td>24.96</td> <td>D:</td> <td>5.43</td> <td>Wt:</td> <td>18.8</td> <td colspan="2"></td> </tr> <tr> <td colspan="10">OUT OF CARTON:</td> </tr> <tr> <td>H:</td> <td>24.41</td> <td>W:</td> <td>25.73</td> <td>D:</td> <td>21.17</td> <td colspan="4"></td> </tr> </table>	\$99.99					\$109.99					MASTER CARTON: 1										H:	18.58	W:	24.96	D:	5.43	Wt:	18.8	Cu.Ft.:	1.46	INDIVIDUAL CARTON:										H:	18.58	W:	24.96	D:	5.43	Wt:	18.8			OUT OF CARTON:										H:	24.41	W:	25.73	D:	21.17					 <p>0 77924 99813 5</p>
\$99.99					\$109.99																																																																					
MASTER CARTON: 1																																																																										
H:	18.58	W:	24.96	D:	5.43	Wt:	18.8	Cu.Ft.:	1.46																																																																	
INDIVIDUAL CARTON:																																																																										
H:	18.58	W:	24.96	D:	5.43	Wt:	18.8																																																																			
OUT OF CARTON:																																																																										
H:	24.41	W:	25.73	D:	21.17																																																																					
3400263	PORTABLE CART	 <ul style="list-style-type: none"> • Top-loading design allows the grill to easily lock in place • Heavy-duty strap keeps grill in place while in motion • Leg locking indicator shows when cart is fully upright • Built-in transport handle for easy mobility • 2 durable, all-terrain wheels 	<table border="1"> <tr> <td colspan="5" style="text-align: right;">\$129.99</td> <td colspan="5" style="text-align: right;">\$139.99</td> </tr> <tr> <td colspan="10">MASTER CARTON: 1</td> </tr> <tr> <td>H:</td> <td>23.62</td> <td>W:</td> <td>36.02</td> <td>D:</td> <td>5.12</td> <td>Wt:</td> <td>34.2</td> <td>Cu.Ft.:</td> <td>2.52</td> </tr> <tr> <td colspan="10">INDIVIDUAL CARTON:</td> </tr> <tr> <td>H:</td> <td>23.62</td> <td>W:</td> <td>36.02</td> <td>D:</td> <td>5.12</td> <td>Wt:</td> <td>34.2</td> <td colspan="2"></td> </tr> <tr> <td colspan="10">OUT OF CARTON:</td> </tr> <tr> <td>H:</td> <td>25.18</td> <td>W:</td> <td>37.86</td> <td>D:</td> <td>23.46</td> <td colspan="4"></td> </tr> </table>	\$129.99					\$139.99					MASTER CARTON: 1										H:	23.62	W:	36.02	D:	5.12	Wt:	34.2	Cu.Ft.:	2.52	INDIVIDUAL CARTON:										H:	23.62	W:	36.02	D:	5.12	Wt:	34.2			OUT OF CARTON:										H:	25.18	W:	37.86	D:	23.46					 <p>0 77924 99814 0</p>
\$129.99					\$139.99																																																																					
MASTER CARTON: 1																																																																										
H:	23.62	W:	36.02	D:	5.12	Wt:	34.2	Cu.Ft.:	2.52																																																																	
INDIVIDUAL CARTON:																																																																										
H:	23.62	W:	36.02	D:	5.12	Wt:	34.2																																																																			
OUT OF CARTON:																																																																										
H:	25.18	W:	37.86	D:	23.46																																																																					
3400015	EXPANDABLE STAND	 <ul style="list-style-type: none"> • Collapsible design for easy transportation • Two side tables for prepping • Adjustable feet keep stand and griddle level • Side tables slide in to create a table for serving • Compatible with Weber Works clip-on accessories 	<table border="1"> <tr> <td colspan="5" style="text-align: right;">\$199.00</td> <td colspan="5" style="text-align: right;">\$219.00</td> </tr> <tr> <td colspan="10">MASTER CARTON: 1</td> </tr> <tr> <td>H:</td> <td>7.85</td> <td>W:</td> <td>24.75</td> <td>D:</td> <td>40.35</td> <td>Wt:</td> <td>42</td> <td>Cu.Ft.:</td> <td>4.54</td> </tr> <tr> <td colspan="10">INDIVIDUAL CARTON:</td> </tr> <tr> <td>H:</td> <td>8.125</td> <td>W:</td> <td>25.75</td> <td>D:</td> <td>41.5</td> <td>Wt:</td> <td>42</td> <td colspan="2"></td> </tr> <tr> <td colspan="10">OUT OF CARTON:</td> </tr> <tr> <td>H:</td> <td>29.8</td> <td>W:</td> <td>66.1</td> <td>D:</td> <td>22.3</td> <td colspan="4"></td> </tr> </table>	\$199.00					\$219.00					MASTER CARTON: 1										H:	7.85	W:	24.75	D:	40.35	Wt:	42	Cu.Ft.:	4.54	INDIVIDUAL CARTON:										H:	8.125	W:	25.75	D:	41.5	Wt:	42			OUT OF CARTON:										H:	29.8	W:	66.1	D:	22.3					 <p>0 77924 98931 5</p>
\$199.00					\$219.00																																																																					
MASTER CARTON: 1																																																																										
H:	7.85	W:	24.75	D:	40.35	Wt:	42	Cu.Ft.:	4.54																																																																	
INDIVIDUAL CARTON:																																																																										
H:	8.125	W:	25.75	D:	41.5	Wt:	42																																																																			
OUT OF CARTON:																																																																										
H:	29.8	W:	66.1	D:	22.3																																																																					
6618	LUMIN COMPACT STAND WITH SIDE TABLE	 <ul style="list-style-type: none"> • Collapsible design for simple setup, breakdown and storage • Built-in hooks to easily access grilling tools • Side table provides room to prep and serve • Durable, fade-resistant material maintains color and longevity 	<table border="1"> <tr> <td colspan="5" style="text-align: right;">\$129.99</td> <td colspan="5" style="text-align: right;">\$139.99</td> </tr> <tr> <td colspan="10">MASTER CARTON: 1</td> </tr> <tr> <td>H:</td> <td>19.8</td> <td>W:</td> <td>21.3</td> <td>D:</td> <td>9.85</td> <td>Wt:</td> <td>12.3</td> <td>Cu.Ft.:</td> <td>2.4</td> </tr> <tr> <td colspan="10">INDIVIDUAL CARTON:</td> </tr> <tr> <td>H:</td> <td>19.8</td> <td>W:</td> <td>21.3</td> <td>D:</td> <td>9.85</td> <td>Wt:</td> <td>12.3</td> <td colspan="2"></td> </tr> <tr> <td colspan="10">OUT OF CARTON:</td> </tr> <tr> <td>H:</td> <td>26.8</td> <td>W:</td> <td>21.6</td> <td>D:</td> <td>21.9</td> <td colspan="4"></td> </tr> </table>	\$129.99					\$139.99					MASTER CARTON: 1										H:	19.8	W:	21.3	D:	9.85	Wt:	12.3	Cu.Ft.:	2.4	INDIVIDUAL CARTON:										H:	19.8	W:	21.3	D:	9.85	Wt:	12.3			OUT OF CARTON:										H:	26.8	W:	21.6	D:	21.9					 <p>0 77924 19655 3</p>
\$129.99					\$139.99																																																																					
MASTER CARTON: 1																																																																										
H:	19.8	W:	21.3	D:	9.85	Wt:	12.3	Cu.Ft.:	2.4																																																																	
INDIVIDUAL CARTON:																																																																										
H:	19.8	W:	21.3	D:	9.85	Wt:	12.3																																																																			
OUT OF CARTON:																																																																										
H:	26.8	W:	21.6	D:	21.9																																																																					
6619	LUMIN STAND WITH SIDE TABLE	 <ul style="list-style-type: none"> • Collapsible design for simple setup, breakdown and storage • Built-in hooks to easily access grilling tools • Side table provides room to prep and serve • Durable, fade-resistant material maintains color and longevity 	<table border="1"> <tr> <td colspan="5" style="text-align: right;">\$129.99</td> <td colspan="5" style="text-align: right;">\$139.99</td> </tr> <tr> <td colspan="10">MASTER CARTON: 1</td> </tr> <tr> <td>H:</td> <td>21.15</td> <td>W:</td> <td>24.95</td> <td>D:</td> <td>10.35</td> <td>Wt:</td> <td>16.5</td> <td>Cu.Ft.:</td> <td>3.16</td> </tr> <tr> <td colspan="10">INDIVIDUAL CARTON:</td> </tr> <tr> <td>H:</td> <td>21.15</td> <td>W:</td> <td>25.0</td> <td>D:</td> <td>10.35</td> <td>Wt:</td> <td>16.5</td> <td colspan="2"></td> </tr> <tr> <td colspan="10">OUT OF CARTON:</td> </tr> <tr> <td>H:</td> <td>28.1</td> <td>W:</td> <td>25.0</td> <td>D:</td> <td>21.8</td> <td colspan="4"></td> </tr> </table>	\$129.99					\$139.99					MASTER CARTON: 1										H:	21.15	W:	24.95	D:	10.35	Wt:	16.5	Cu.Ft.:	3.16	INDIVIDUAL CARTON:										H:	21.15	W:	25.0	D:	10.35	Wt:	16.5			OUT OF CARTON:										H:	28.1	W:	25.0	D:	21.8					 <p>0 77924 19656 0</p>
\$129.99					\$139.99																																																																					
MASTER CARTON: 1																																																																										
H:	21.15	W:	24.95	D:	10.35	Wt:	16.5	Cu.Ft.:	3.16																																																																	
INDIVIDUAL CARTON:																																																																										
H:	21.15	W:	25.0	D:	10.35	Wt:	16.5																																																																			
OUT OF CARTON:																																																																										
H:	28.1	W:	25.0	D:	21.8																																																																					



ACCESSORIES



MAP



MSRP

MERCHANDISE: TOOL HOOKS AND GRILL LIGHTS

3400249	GRILL 'N GO LIGHT		\$49.99	\$54.99	 0 77924 99812 6		
	<ul style="list-style-type: none"> • LED illuminates the entire cooking surface • On/off motion sensor saves battery life • Can be detached and used as a flashlight • Easily attaches to the grill handle • Fits handles on WEBER Q grills 	MASTER CARTON: 4					
		H: 5.2	W: 4.46	D: 7.68		Wt: 1.66	Cu.Ft.: 0.10
		INDIVIDUAL CARTON:					
		H: 4.53	W: 4.33	D: 1.78	Wt: 0.41		
		OUT OF CARTON:					
		H: 4.53	W: 1.80	D: 4.33			









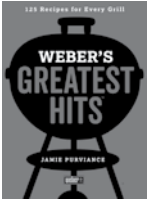

3400266	GRILL 'N GO LIGHT		\$49.99	\$54.99	 0 77924 99816 4		
	<ul style="list-style-type: none"> • LED illuminates the entire cooking surface • On/off motion sensor saves battery life • Can be detached and used as a flashlight • Easily attaches to the grill handle • Fits handles on WEBER Traveler and Lumin grills 	MASTER CARTON: 4					
		H: 5.83	W: 4.88	D: 8.07		Wt: 1.64	Cu.Ft.: 0.13
		INDIVIDUAL CARTON:					
		H: 4.53	W: 4.33	D: 1.78	Wt: 0.41		
		OUT OF CARTON:					
		H: 6.25	W: 2.38	D: 2.5			

7401	TOOL HOOKS		\$8.49	\$9.49	 0 77924 06864 5		
	<ul style="list-style-type: none"> • Hang essential grilling tools for easy access and organization of your backyard workspace • Fits 18 inch and 22 inch WEBER charcoal grills 	MASTER CARTON: 6					
		H: 8.82	W: 8.19	D: 9.44		Wt: 2.17	Cu.Ft.: 0.39
		INDIVIDUAL CARTON:					
		H: 8.0	W: 3.63	D: 2.75	Wt: 0.25		
		OUT OF CARTON:					
		H: 7.0	W: 2.0	D: 3.5			

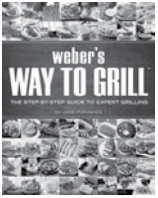
7661	GRILL 'N GO HANDLE LIGHT		\$40.49	\$45.49	 0 77924 11405 2		
	<ul style="list-style-type: none"> • LED illuminates the entire cooking surface • Detachable to shine extra light where you need it • Motion sensor with an on/off switch saves battery life • Fits round handles on WEBER SPIRIT, GENESIS and SUMMIT gas grill models year 2007 and newer. Fits SEARWOOD 600 and SEARWOOD 600 XL prltry grills. Fits all SPIRIT II, GENESIS II grill models • Includes 3 AAA batteries / 20 hours 	MASTER CARTON: 4					
		H: 5.83	W: 4.88	D: 8.07		Wt: 1.82	Cu.Ft.: 0.13
		INDIVIDUAL CARTON:					
		H: 4.53	W: 4.33	D: 1.78	Wt: 0.41		
		OUT OF CARTON:					
		H: 4.2	W: 2.5	D: 3.0			

MSRP

MERCHANDISE: COOKBOOKS

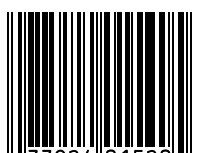
9557		WEBER'S GREATEST HITS Soft cover; 320 pages		\$24.99	Master Carton: 10	
					H: 9.6 W: 9.5 D: 11.8 Wt: 29.0 Cu.Ft.: 0.6	
					Individual Book:	
					H: 11.38 W: 9.0 D: 0.75 Wt: 2.9	
9554		WEBER'S NEW AMERICAN BARBECUE Soft cover; 304 pages		\$24.99	Master Carton: 10	
					H: 10.0 W: 8.8 D: 11.2 Wt: 26.0 Cu.Ft.: 0.6	
					Individual Book:	
					H: 0.9 W: 8.5 D: 10.9 Wt: 2.6	
9551		WEBER'S WAY TO GRILL Soft cover; 320 pages		\$24.99	Master Carton: 10	
					H: 9.6 W: 9.4 D: 11.8 Wt: 29 Cu.Ft.: 0.6	
					Individual Book:	
					H: 0.8 W: 9.0 D: 11.4 Wt: 2.9	
202609		WEBER'S WAY TO GRILL DISPLAYER 1 displayer / 5 cookbooks		\$24.99 per book	Master Carton: 1	
					H: 8.1 W: 9.8 D: 12 Wt: 15.5 Cu. Ft.: 0.5	
7605		WEBER'S SMOKE Soft cover; 192 pages		\$24.95	Master Carton: 10	
					H: 7.7 W: 9.8 D: 10.6 Wt: 16.7 Cu.Ft.: 0.5	
					Individual Book:	
					H: 0.7 W: 9.5 D: 10.3 Wt: 1.7	
207605		WEBER'S SMOKE DISPLAYER 1 displayer / 5 cookbooks		\$24.95 per book	Master Carton: 1	
					H: 4.8 W: 10.7 D: 11.8 Wt: 9.5 Cu. Ft.: 0.3	

REPRESENTATIVES

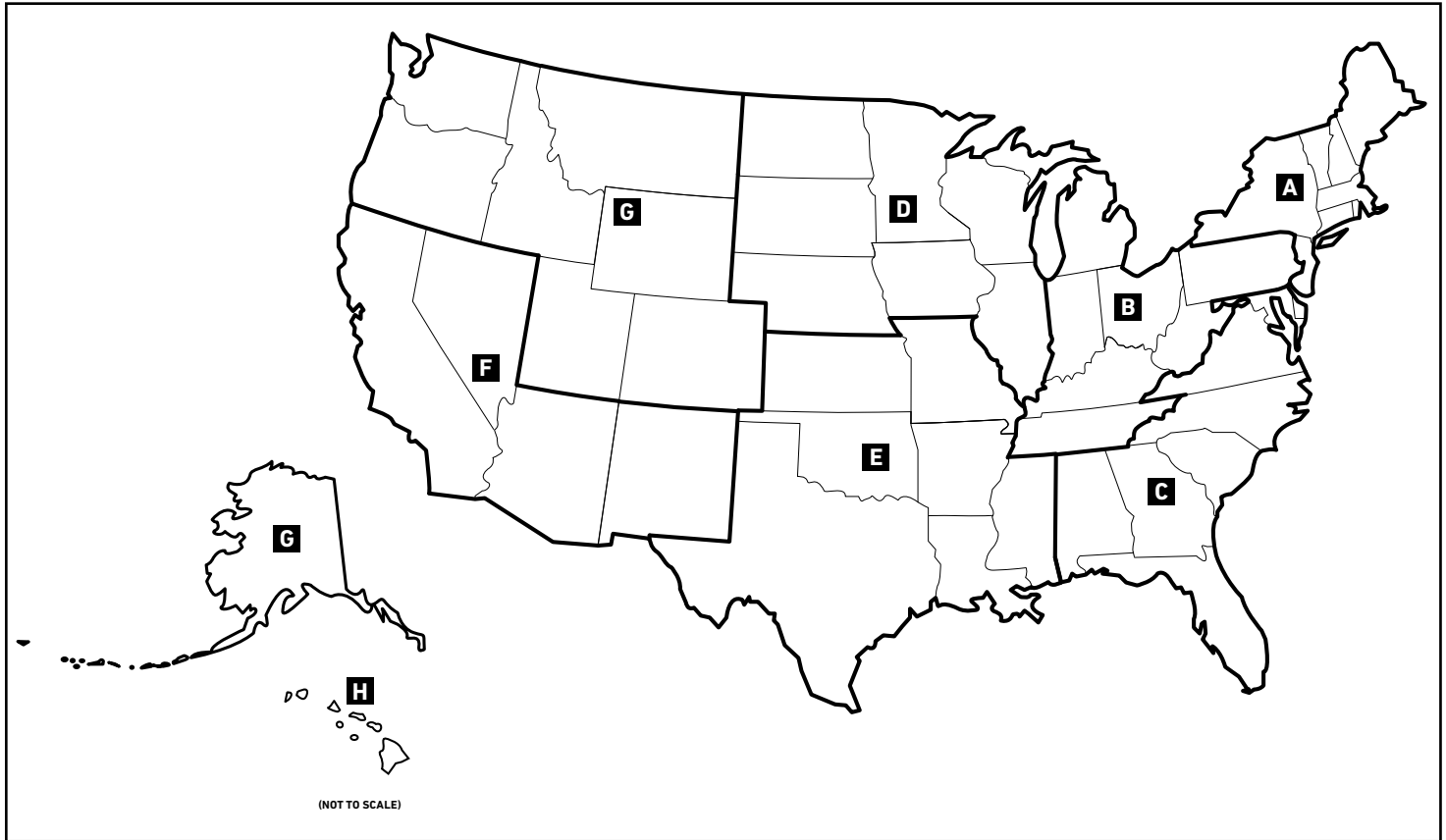

A NJ-NY-CT-RI-MA-VT-NH-ME

Tim Classey
1000 W. Touhy Avenue
Park Ridge, IL 60068
Office: 847-823-1575
Cell: 203-326-1526
tclassey@skkr.com

B OH-MI-IN-KY-TN-PA-WV

Todd Kisting
1000 W. Touhy Avenue
Park Ridge, IL 60068
Office: 847-823-1575
Cell: 847-370-1264
tkisting@skkr.com

C FL-AL-GA-NC-SC-VA-MD-DE

Wade Wilcox
1000 W. Touhy Avenue
Park Ridge, IL 60068
Office: 847-823-1575
Cell: 678-522-5340
wwilcox@skkr.com

D IL-WI-MN-ND-SD-IA-NE

Sean Hanley
1000 W. Touhy Avenue
Park Ridge, IL 60068
Office: 847-823-1575
Cell: 708-557-6699
shanley@skkr.com

E MO-KS-OK-TX-AR-MS-LA

Sean Noonan
1000 W. Touhy Avenue
Park Ridge, IL 60068
Office: 847-823-1575
Cell: 217-691-0910
snoonan@skkr.com

F Northern CA-Northern NV-So CA So NV-AZ-NM

Chris Kjome
6825 216TH St. SW, Ste E
Lynnwood, WA 98036
Office: 425-347-4249
Cell: 916-715-6391
bbqservice@kwawest.com

G WA-OR-ID-MT-AK-CO-UT-WY

Scott Hayhurst
6825 216TH St. SW, Ste E
Lynnwood, WA 98036
Office: 425-347-4249
Cell: 916-715-6391
bbqservice@kwawest.com

H HI

Ryan Cresford
94-155 Leowaena Street
Waipahu, HI 96797
Office: 808-671-2817
ryan@pacwesthi.com

GRILLS: OUT-OF-PACKAGE DIMENSIONS - FULLY ASSEMBLED

HEIGHT

Vertical measurement

WIDTH

Horizontal measurement

DEPTH

Distance from front to back

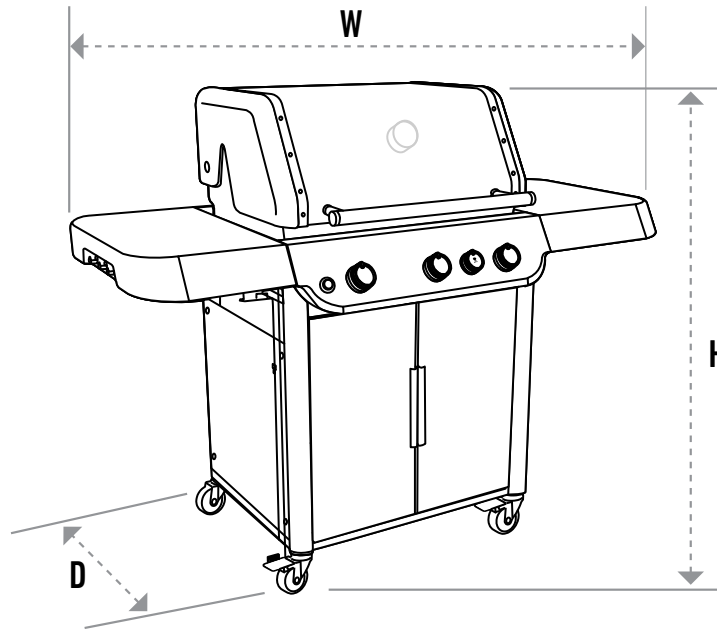

ACCESSORIES: OUT-OF-PACKAGE DIMENSIONS - PRODUCT LAYING FLAT

HEIGHT

Vertical measurement

WIDTH

Horizontal measurement

DEPTH

Distance from front to back

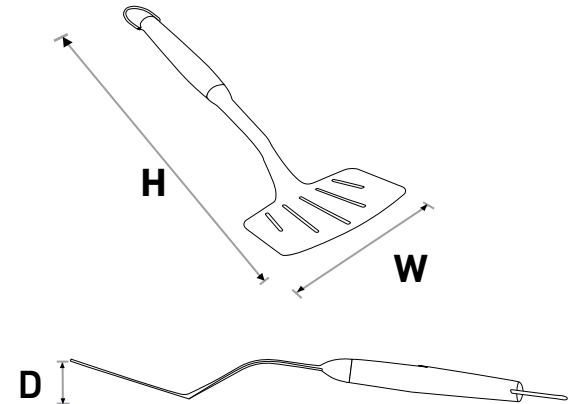
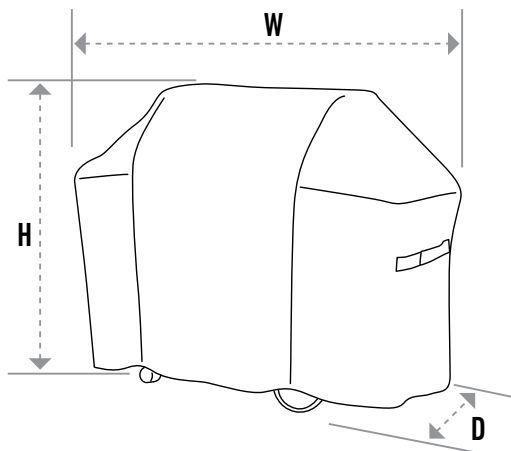

ACCESSORIES: UNIT PACKAGE - UPRIGHT

HEIGHT

Vertical measurement

WIDTH

Horizontal measurement

DEPTH

Distance from front to back

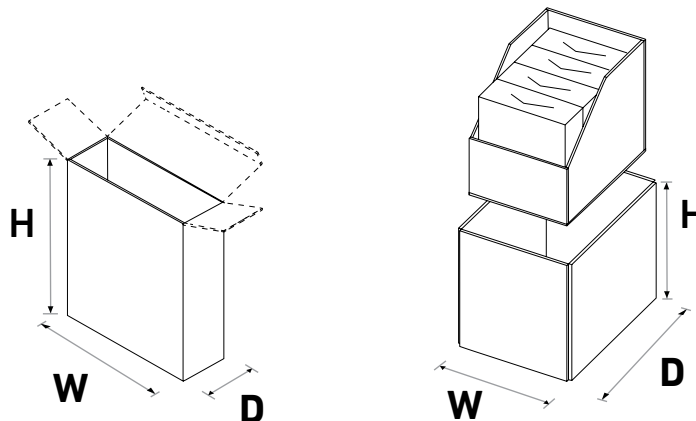

INDEX

2290	55	6605	53	7005	62
3201	37	6608	40	7007	60
3250	37	6611	56	7008	62
3254	37	6612	56	7017	62
6275	68	6613	61	7030	70
6276	68	6614	61	7031	62
6277	68	6618	83	7034	56
6278	68	6619	83	7035	72
6279	68	6645	40	7036	72
6319	40	6691	63	7110	73
6320	39	6707	40	7137	74
6414	76	6731	53	7138	74
6415	69	6750	38	7139	74
6416	69	6768	39	7148	75
6434	52	6769	39	7150	75
6435	52	6770	39	7151	75
6469	53	6771	40	7152	76
6470	53	6772	40	7153	76
6471	54	6776	42	7154	75
6481	52	6777	42	7173	76
6482	53	6778	44	7174	76
6483	63	6779	44	7175	75
6488	64	6780	44	7176	75
6489	63	6781	44	7196	70
6498	69	6782	45	7197	70
6501	77	6783	45	7202	37
6532	64	6784	45	7203	37
6533	64	6785	45	7211	38
6534	64	6786	45	7212	38
6535	64	6787	55	7401	84
6558	57	6788	55	7403	61
6572	43	6789	56	7416	60

7417	60	7606	49	7856	49
7421	51	7620	78	7859	50
7431	82	7627	79	7860	50
7432	82	7628	79	8025	67
7433	81	7629	80	8026	67
7435	81	7639	77	8027	67
7436	81	7641	80	8028	67
7439	81	7642	80	8029	67
7440	81	7644	77	8829	52
7441	81	7647	53	8834	51
7444	82	7649	61	8835	52
7447	61	7652	55	8836	51
7459	69	7658	57	8838	51
7478	82	7661	84	8859	51
7480	60	7666	60	8860	51
7481	60	7670	48	9349	43
7502	78	7671	48	9551	85
7507	79	7672	48	9554	85
7508	79	7673	48	9557	85
7509	79	7675	48	10020	27
7510	79	7676	48	17136	65
7513	80	7677	49	17137	65
7515	80	7678	49	17138	65
7524	77	7696	62	17139	65
7528	77	7757	74	17140	66
7534	77	7758	74	17142	66
7536	78	7770	70	17143	66
7540	78	7771	72	17148	66
7576	65	7849	50	17149	66
7598	57	7852	50	17150	66
7599	57	7853	49	17302	65
7605	85	7854	50	40020	27

INDEX

60020	36	1500379	14	1500789	17
190001	58	1500390	15	1500790	18
190002	58	1500391	15	1500791	18
190003	58	1500392	15	1500792	18
190004	59	1500393	15	1500844	17
190005	59	1500394	15	1500845	18
202609	85	1500420	4	1501000	16
207605	85	1500460	12	1501005	6
441001	30	1500531	2	1501006	6
711001	36	1500532	2	1501345	3
721001	36	1500533	22	1501350	5
731001	36	1500534	22	3400015	83
741001	30	1500535	23	3400016	39
1126801	27	1500536	23	3400021	42
1141001	28	1500537	23	3400022	42
1211001	27	1500538	23	3400023	42
1321001	29	1500539	24	3400024	42
1500010	21	1500568	21	3400030	72
1500011	21	1500569	21	3400061	43
1500013	4	1500576	22	3400073	44
1500014	3	1500577	22	3400074	43
1500064	31	1500580	24	3400075	63
1500065	31	1500763	28	3400076	43
1500120	7	1500780	17	3400104	47
1500121	7	1500781	17	3400105	47
1500216	5	1500782	19	3400106	47
1500367	24	1500783	19	3400107	47
1500368	24	1500784	19	3400108	59
1500375	14	1500785	19	3400109	59
1500376	14	1500786	20	3400119	71
1500377	14	1500787	20	3400120	71
1500378	14	1500788	16	3400121	71

3400122	71	3400321	38	15501001	34
3400123	44	3400322	37	15502001	34
3400125	63	3400324	38	15507001	34
3400127	62	3400335	70	18201001	35
3400128	47	3400382	56	18501101	35
3400131	46	3400423	41	35600001	26
3400134	63	3400424	41	36400001	25
3400140	59	3400425	41	36410001	25
3400145	73	3400426	41	37600001	26
3400146	73	3400516	38	38400001	25
3400164	41	3400518	46	38800001	25
3400165	41	3400519	46	50060001	12
3400201	71	3400656	58	51010001	13
3400215	43	3400660	58	51040001	13
3400220	46	3400665	46	51060001	13
3400232	73	3400713	67	51070001	13
3400233	73	3400714	68	51080001	13
3400246	54	9010001	11	51190001	13
3400247	56	9013001	11	52020001	10
3400248	57	9020001	11	91010901	8
3400249	84	9030001	11	91070901	8
3400250	59	14401001	30	91280901	8
3400252	54	14402001	30	91300901	8
3400260	46	14407001	30	91400901	8
3400262	83	14501001	32	92010901	9
3400263	83	14505601	32	92070901	9
3400264	55	14510601	32	92280901	9
3400265	54	14511601	32	92300901	9
3400266	84	14513601	32	92400901	9
3400267	54	14516001	32		
3400301	78	15301001	33		
3400302	78	15401001	33		

©2024 Weber-Stephen Products LLC. Weber, the kettle silhouette, kettle configuration are registered U.S. Trademarks all of Weber-Stephen Products LLC, 1415 S. Roselle Road, Palatine, Illinois 60067 USA.

The Bluetooth® word mark and logos are registered trademarks owned by the Bluetooth SIG, Inc. and any use of such marks by Weber-Stephen Products LLC is under license. Other trademarks and trade names are those of their respective owners.