

# PE304HB

30" BUILT-IN INDUCTION COOKTOP WITH CONCEALED CENTRIC DIGITAL TOUCH CONTROL SLIDER INTERFACE



## PRODUCT DIMENSIONS

TOP VIEW

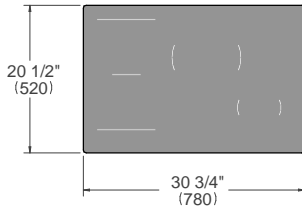

FRONT VIEW

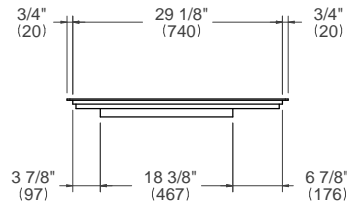

SIDE VIEW

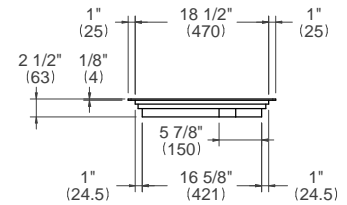

## ELECTRICAL & GAS CONNECTION

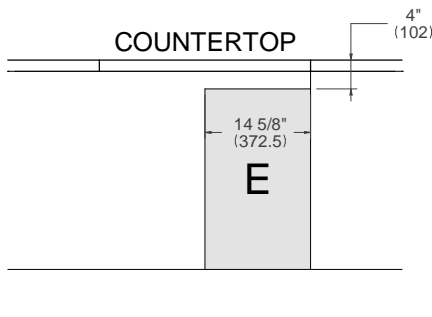

**E** A properly-grounded, horizontally-mounted electrical receptacle should be installed according this drawing.

## INSTALLATION REQUIREMENTS

Combustible material cannot be located within shaded area above countertop.

## CUTOUT DIMENSIONS

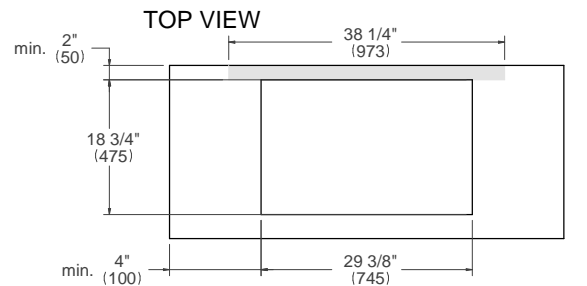

SIDE VIEW

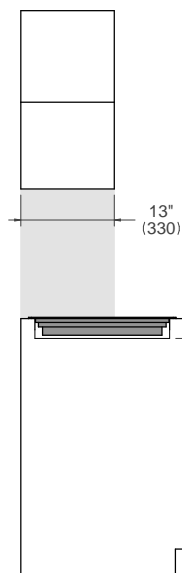

FRONT VIEW

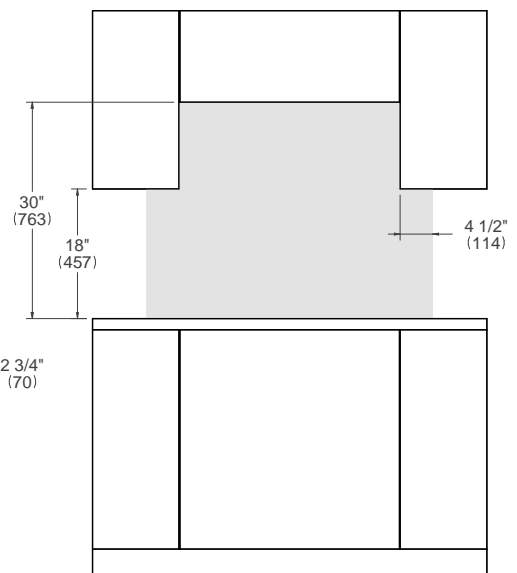

For installation of multiple products in combination, refer to the Design Guide at [us.bertazzoni.com](http://us.bertazzoni.com) or [ca.bertazzoni.com](http://ca.bertazzoni.com)

**Disclaimer:** while every effort has been made to ensure the accuracy of the information contained in this document, Fratelli Bertazzoni reserves the right to change it at any time without notice. For detailed installation instructions, consult the installation manual. Fratelli Bertazzoni, Bertazzoni and the winged wheel brand icon are registered trademarks of Bertazzoni Spa.