

PE304TB

30" BUILT-IN INDUCTION COOKTOP
TFT INTERFACE WITH AUTOMATED SENSOR COOKING

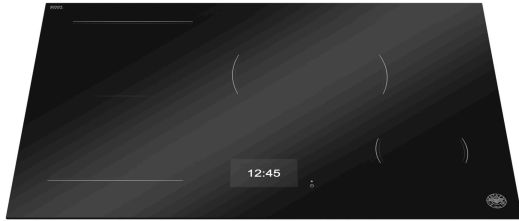

High-end TFT Display

The 7" multi-color TFT display offers an advanced and intuitive cooking interface, making it easy to adjust power levels and monitor heat in real time. All main functions are directly accessible on the interface and, thanks to the Automatic Pot Recognition, just a single touch is required to complete all daily actions.

Distinctive Italian Design

The minimal serigraphies contribute to a clean and refined aesthetic, blending seamlessly into modern kitchen environments. When the cooktop is powered off, the interface remains completely invisible, preserving the minimalist design. When activated, the high-resolution TFT display provides an intuitive and sophisticated user experience.

Bertazzoni Assistant - Smart Cooking Precision

The Bertazzoni Assistant is an intelligent cooking system designed to ensure optimal results by directly controlling the temperature inside cookware. Thanks to advanced sensors placed at the center of each cooking zone, it continuously monitors and adjusts the heat to maintain precision and consistency. This technology allows users to cook with confidence, ensuring perfect outcomes with minimal effort. The 5 programs are: Temperature Holding, Water Boiling, Steaming, Pasta Cooking and Frying.

The Most Advanced Induction Technology Ever

With advanced Half-Bridge inductors, TFT cooktops deliver precise power control for ultra-fast heating and perfect simmering. Up to 3.7kW boost ensures rapid boiling, while ultra-low duty cycle keeps low temperatures stable, preserving delicate flavors.

PRODUCT FEATURES

Product type	30" Induction cooktop with 4 induction zones
User interface	Full Touch TFT Display
Numbers of zones	4 induction zones
Heating zone power	Front Left 7 1/2 x 8 1/4 - 2100W (3700 W) Back Left 7 1/2 x 8 1/4 - 2100W (3700 W) Center Ø 10 1/4 - 2600W (3700 W) Front Right Ø 5 11/16 - 1400W (2200 W)
Booster and Double Booster	yes
Multi-zone	1 Multi-zone
Bertazzoni Assistant	yes
Automated Sensor Cooking	5 automatic programmes: 1. Temperature holding 2. Water boiling 3. Steaming 4. Pasta 5. Frying
Timer	yes
Pause and Recal	yes
Child lock	yes
Residual heat indicator	yes

TECHNICAL SPECIFICATIONS

Electrical supply	208 V - 60 HZ / 240 V 60 HZ 6700 W 32 Amp
Power connection	Metal conduit with 71" power cord
Certification	UL
Warranty	2 years parts & labor
Product dimensions and net weight	W: 30 3/4" H: 2 1/2" D: 20 1/2" 40 lbs
Cut-out dimensions	W: 29 3/8" H: 2 3/4" D: 18 3/4"
Packaging dimensions and gross weight	W: 37 1/4" H: 6 19/64" D: 26 3/16" 44 lbs

ACCESSORY

GR22ICI	Cast iron griddle for induction
---------	---------------------------------

PE304TB

30" BUILT-IN INDUCTION COOKTOP
TFT INTERFACE WITH AUTOMATED SENSOR COOKING



PRODUCT DIMENSIONS

TOP VIEW

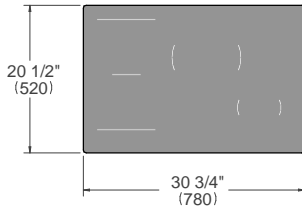

FRONT VIEW

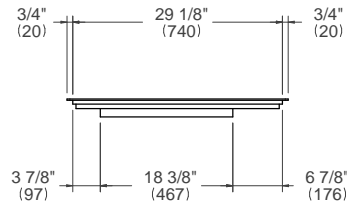

SIDE VIEW

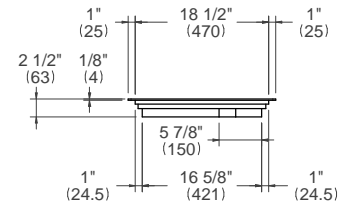

ELECTRICAL & GAS CONNECTION

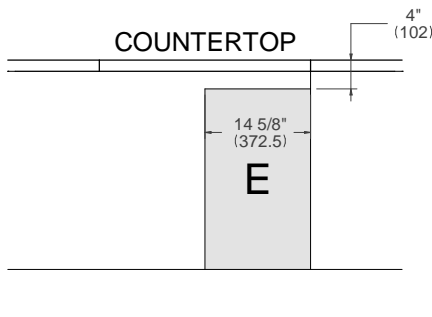

E A properly-grounded, horizontally-mounted electrical receptacle should be installed according this drawing.

INSTALLATION REQUIREMENTS

Combustible material cannot be located within shaded area above countertop.

CUTOUT DIMENSIONS

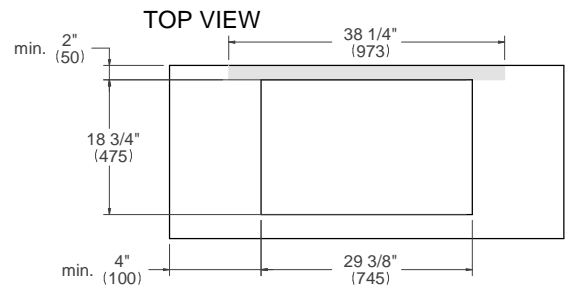

SIDE VIEW

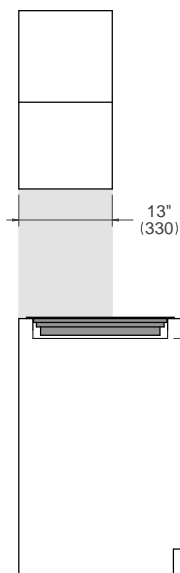

FRONT VIEW

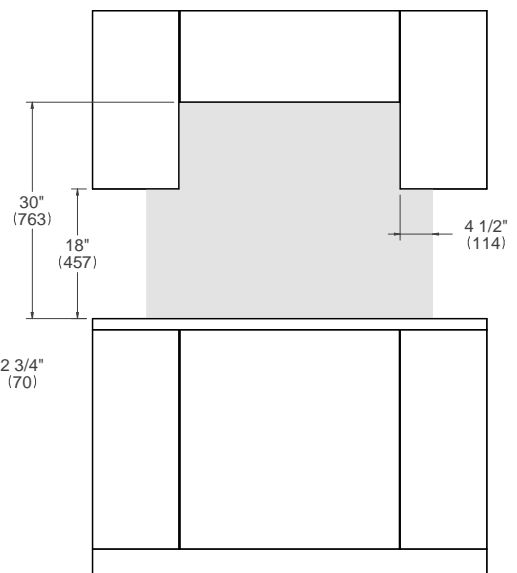

For installation of multiple products in combination, refer to the Design Guide at us.bertazzoni.com or ca.bertazzoni.com

Disclaimer: while every effort has been made to ensure the accuracy of the information contained in this document, Fratelli Bertazzoni reserves the right to change it at any time without notice. For detailed installation instructions, consult the installation manual. Fratelli Bertazzoni, Bertazzoni and the winged wheel brand icon are registered trademarks of Bertazzoni Spa.