

## Use, Care and Installation Manual

Models: RNF242WCL, RNF242WCR



### Table of Contents

Important Safety Instructions .....	1
Getting to Know Your Wine Cellar .....	3
Operating Your Wine Cellar.....	3
Care and Cleaning .....	6
Specifications and Installation.....	7
Before You Call for Service.....	8
Warranty .....	10
Warranty Card .....	Back Cover



To Our Valued Customer:

Congratulations on your purchase of the very latest in Dacor® products! Our unique combination of features, style and performance make us The Life of the Kitchen™, and a great addition to your home.

In order to familiarize yourself with the controls, functions and full potential of your new Distinctive Appliance, read this use and care manual thoroughly, beginning with the **Important Safety Instructions** section.

All Dacor appliances are designed and manufactured with quality and pride, while working within the framework of our company value. Should you ever experience a problem with your product, please first check the **Before You Call for Service** section of this manual for guidance. It provides useful suggestions and remedies prior to calling for service.

Valuable customer input helps us to continuously improve our products and services, so please feel free to contact our Customer Service Team for assistance with any of your product support needs.

Dacor Customer Service Team  
14425 Clark Avenue  
City of Industry, CA 91745

Telephone: (800) 793-0093  
Fax: (626) 403-3130  
Hours of Operation: Monday through Friday  
6:00 A.M. to 5:00 P.M. Pacific Time

Web Site: [www.dacor.com](http://www.dacor.com)

Thank you for choosing Dacor for your home. We are a company built by families for families and we are dedicated to serving yours. We are confident that your new Dacor product will deliver a high level of performance and enjoyment for many years to come.

Sincerely,

*The Dacor Customer Service Team*

# Important Safety Instructions

**INSTALLER:** Leave these instructions with the appliance.

**CUSTOMER:** Read this use and care manual completely before using your appliance. Save it for future reference. It contains important use and care information. Retain your sales receipt or canceled check. Proof of original purchase date is required for warranty service.

**For warranty and service information, see page 10.**

If you have any questions, call:

Dacor Customer Service  
(800) 793-0093 (U.S.A. and Canada)  
Monday — Friday 6:00 A.M. to 5:00 P.M. Pacific Time

Web site: [www.dacor.com](http://www.dacor.com)

Have the complete model and serial number identification of your appliance ready. These numbers are found on the product data label located inside the door. Record these numbers below for easy access.

Model number \_\_\_\_\_

Serial number \_\_\_\_\_

Date of purchase \_\_\_\_\_

Since we continually improve the quality and performance of our products, we may make changes to the appliance without updating this manual. Visit [www.dacor.com](http://www.dacor.com) to download the latest version of this manual.

## About Safety Instructions

The **Important Safety Instructions** and warnings in this manual are not meant to cover all possible problems and situations that can occur. Use common sense and caution when installing, maintaining or operating this or any other appliance.

Always contact the Dacor Customer Service Team about problems or situations that you do not understand.

## Safety Symbols and Labels

### **DANGER**

**DANGER** – Immediate hazards that **WILL** result in severe personal injury or death.

### **WARNING**

**WARNING** – Hazards or unsafe practices that **COULD** result in severe personal injury or death.

### **CAUTION**

**CAUTION** – Hazards or unsafe practices that **COULD** result in minor personal injury or property damage.

### **DANGER**

**IMPORTANT:** To prevent child entrapment and suffocation when discarding an old appliance:

- Take off the door(s).
- Leave the racks in place so children cannot easily climb inside.
- Cut the prongs off the power plug and discard them.
- Cut the power cable off and discard it separately from the old appliance.

**IMPORTANT:** To avoid the possibility of explosion or fire, do not store or use combustible, flammable or explosive vapors and liquids (such as gasoline) inside or in the vicinity of this or any other appliance.

### **WARNING**

**IMPORTANT:** This appliance is equipped with a three prong grounding electric plug for protection against possible electric shock hazards. It must be plugged into a dedicated, grounded, electrical outlet. If only a two prong electrical outlet is available, it is the responsibility of the customer to have it replaced with a dedicated, properly grounded three prong electrical outlet.

- **DO NOT** cut or remove the third (ground) prong from the power cord.
- **DO NOT** use an adapter plug.
- **DO NOT** use a power cord that is frayed or damaged.
- **DO NOT** connect the appliance to an extension cord.
- Keep the power cord away from heated surfaces.

**NOTE:** Use of an electrical outlet with a ground fault interrupter (GFI) is not recommended.

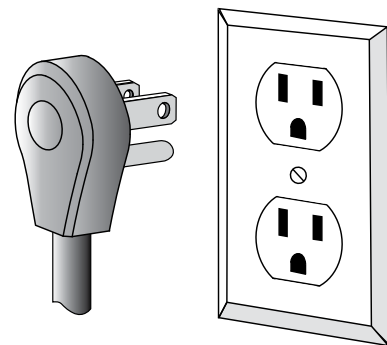

Power cord with three prong grounding plug

Grounded type electrical outlet

State of California Proposition 65 Warnings:

**WARNING:** This product contains one or more chemicals known to the State of California to cause cancer.

**WARNING:** This product contains one or more chemicals known to the State of California to cause birth defects or other reproductive harm.

# READ AND SAVE THESE INSTRUCTIONS

# Important Safety Instructions

## General Safety Precautions

To reduce the risk of fire, electric shock, serious injury or death when installing and using your appliance, follow basic safety precautions, including the following:

### **WARNING**

- If you receive a damaged product, immediately contact your dealer or builder. Do not install or use a damaged appliance.
- Make sure that this appliance has been properly installed according to the installation section. Make sure you know the location of the electrical outlet so that you know where and how to disconnect power. Making sure the appliance is properly installed is the responsibility of the customer.
- This appliance is not designed for installation in a recreational vehicle or boat.
- To prevent personal injury, property damage or damage to the unit, this appliance should only be unpacked and set up by two people according to the installation section.
- Refrigeration equipment must be properly disposed of in a professional and appropriate way, in accordance with the current local regulations and laws which protects the environment. This applies to your old appliance and to your new unit once it has reached the end of its service life. DO NOT dispose of the appliance in a landfill as the insulation (Cyclopentane) and refrigerant gas (R600a) contained in these appliances are flammable.
- Do not install or use outdoors or in wet conditions.
- Do not place another appliance on top of the appliance.
- Keep packaging materials away from children. Plastic sheets and bags can cause suffocation.
- Connect this appliance to a 115 Vac, 15 Amp. circuit that is controlled by a circuit breaker or fuse. This appliance should have its own separate grounded circuit.
- Do not kink or pinch the power supply cord of the appliance. Never unplug the appliance by pulling on the power cord. Always grip the plug firmly and pull straight out from the electrical outlet.
- To avoid an electric shock hazard, do not operate this appliance with wet hands, or while standing in water or on a wet surface.
- Disconnect this appliance when not in use.
- Do not install, repair or replace any part of the appliance unless specifically recommended in the literature accompanying it. A qualified service technician should perform all other service.
- Before performing any type of service, disconnect the unit from the electrical outlet.
- Use this appliance only for its intended purpose, the storage of wine and beverage products. Do not use it to store perishable food, medicine or other medical products. It is not intended for commercial or industrial use.
- Never allow children to operate, play with or crawl inside the appliance.
- Never allow anyone, including children to sit, stand or climb on any part of the appliance, including the door. Doing so may cause damage, serious injury or death.
- If the power cord is damaged, it must be replaced by the manufacturer or a qualified service technician in order to avoid a safety hazard.

### **WARNING**

- Do not tamper with the controls.
- This appliance is CFC and HFC free and contains small quantities of Isobutane (R600a) which is environmentally friendly, but flammable. Care must be taken during transportation and setting up of the appliance so that no parts of the cooling system are damaged. Leaking coolant can ignite and may damage the eyes. In the event of any damage:
  - Avoid open flames and anything which creates a spark.
  - Disconnect the power cord from the electrical outlet.
  - Air the room in which the appliance is located for several minutes and contact Dacor Customer Service for advice.
- The more coolant there is in an appliance, the larger the room it should be installed in. In the event of a leakage, if the appliance is in a small room, there is the danger of combustible gases building up. For every ounce of coolant, at least 325 cubic feet of room space is required. The amount of coolant in the appliance is stated on the data label inside the door. It is hazardous for anyone other than factory authorized service personnel to carry out service or repairs on this appliance.
- All service and replacement of component parts shall be performed by factory authorized service personnel, so as to minimize the risk of possible ignition due to incorrect parts or improper service.
- Take care when handling, moving and using the appliance to avoid either damaging the refrigerant tubing or increasing the risk of a leak.
- Keep fingers out of the "pinch point" areas. Clearances between the doors and between the doors and cabinet are necessarily small. Be careful closing doors when children are in the area.
- Do not cover shelves with aluminum foil or any other shelf material which may prevent air circulation.

### **CAUTION**

- In the event of a power outage, minimize opening the door.
- Do not allow the ventilation grill below the door to become obstructed. Make sure there is always good ventilation in front of the appliance.

# Getting to Know Your Wine Cellar

## Features

### The right environment for your wines...

A vine is an extremely sensitive plant. Grape quality is dependent on three factors: light, air humidity and ambient temperature. This sensitivity continues even after the wine is bottled. To allow a wine's flavor to fully develop and to preserve the excellent aroma, it has to be properly stored. Your wine cellar offers the best storage environment:

- ❖ **A wide temperature range:** The unit has two separate cooling compartments, or zones. Each zone has a wide temperature adjustment range. You can set one zone to store wine at low temperature for superb aging and set the other to a higher temperature for serving wine lightly chilled.
- ❖ **High storage capacity:** High storage capacity allows you to preserve the flavor of your favorite wines. Your wine cellar can store up to 46 bottles of wine (750 mL each). The capacity of the upper zone is 16 bottles. The lower zone can hold up to 30 bottles.
- ❖ **Low Vibration Cooling System and Storage:** Wines require a tranquil environment. The latest technology of your wine cellar provides virtually vibration free cooling, helping to preserve wine taste. In addition, the sliding beechwood storage shelves also provide additional vibration absorption.

### Additional Features

- Automatic defrosting system
- Soft white LED interior lighting with on/off switch
- Open-door and malfunction warning system
- Double-layer, UV resistant, tempered glass door, shields wines from UV rays harmful to wine.
- Door lock

## Door Lock

The door is unlocked when the key is in the horizontal position and locked when in the vertical position.

### To lock the door:

1. With the door closed, insert the key into the lock.
2. Push in and turn the key 90° clockwise to lock.
3. Remove the key.

### To unlock the door:

1. Insert the key into the lock.
2. Push in and turn the key 90° counterclockwise to unlock.

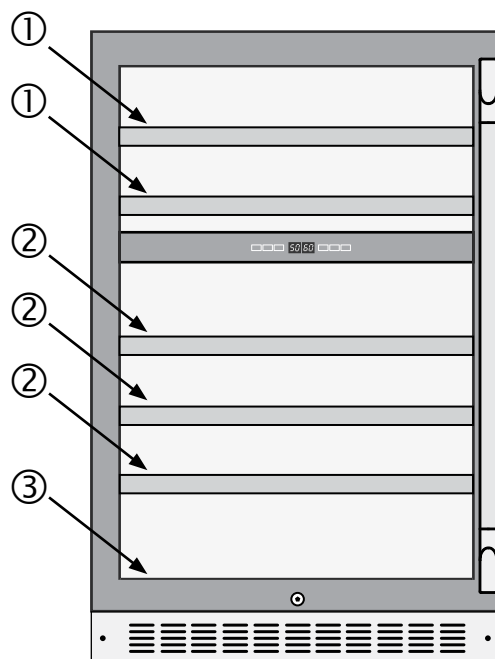

**Model RNF242WCL: Hinges on left, handle on right**  
**Model RNF242WCR: Hinges on right, handle on left**

### Racks/Shelves (see diagram above)

- ① Wood slide-out racks, upper zone: Hold up to eight bottles of wine each.
- ② Wood slide-out racks, lower zone: Hold up to eight bottles of wine each.
- ③ Bottom shelf (lower zone): Holds up to six bottles of wine.

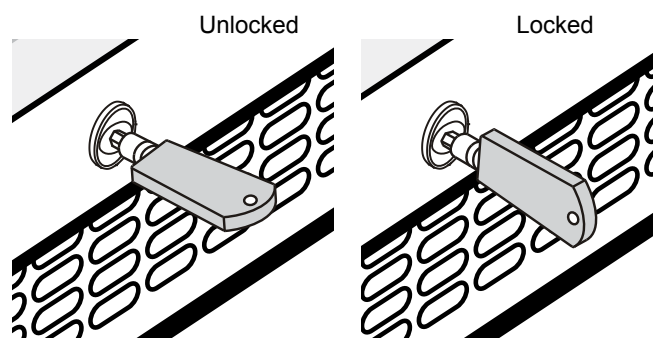
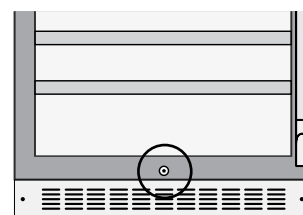

# Operating Your Wine Cellar

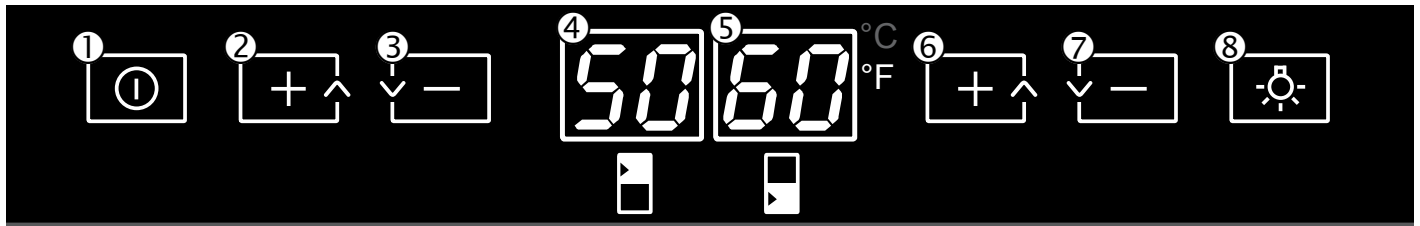

## The Control Panel

- ① ON/OFF key
- ② Upper zone temperature UP key
- ③ Upper zone temperature DOWN key
- ④ Upper zone temperature display
- ⑤ Lower zone temperature display
- ⑥ Lower zone temperature UP key
- ⑦ Lower zone temperature DOWN key
- ⑧ LIGHT key

### Turning the Power ON and OFF

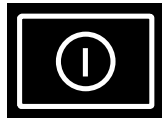

- Clean your appliance before turning it on for the first time. See the **Care and Cleaning** section.
- Connect the power cord to the electrical outlet. The unit will come on.
- To turn the unit off, touch and hold the **ON/OFF** key for about five seconds. The display will turn off to indicate that the appliance is off.
- To turn it on, touch the **ON/OFF** key until the display lights up.

**IMPORTANT:** This unit has a compressor reset delay designed to protect the compressor when it is warm. If the unit will not start, unplug the power cord for 5 minutes, then reconnect.

## Setting the Temperature

The temperature of both zones can be set between 41°F and 72°F (5°C and 22°C). The lower temperature zone is ideal for storing white and red wine at a setting of 55°F to 72°F (13°C to 22°C). The upper temperature zone is suitable for storing champagne and white wine at a setting of 41°F to 55°F (5°C to 13°C).

**IMPORTANT:** The temperature set for the LOWER temperature zone must always be just as high or higher than that in the UPPER temperature zone. For optimal performance, the set temperature of the two zones should differ by at least 39°F (4°C).

- Touch the **UP** or **DOWN** key for the upper or lower zone repeatedly to raise or lower the temperature for that zone. You can change the settings in increments of 1°F (or 1°C). The temperature setting will flash on the display while you change it.
- After five seconds the display will stop flashing and the actual temperature of the zone will be displayed.

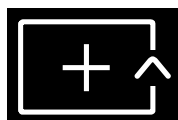

UP Key



DOWN key

**NOTE:** Depending on the amount of temperature change, it may take a few minutes to a few hours for the compartment temperature to reach the newly adjusted temperature level.

## Changing the temperature scale (°F or °C)

You can select the temperature scale that the unit uses to display the temperature settings:

- Touch and hold the **LIGHT** key for about five seconds. The temperature scale indicator light on the right side of the display will change to indicate the new temperature scale. Touch and hold the **LIGHT** key again to change back.



LIGHT Key

## Interior Lighting

You can set the interior lighting so that it is on all the time, or so that it comes on only when the door is open. To make the light turn off when the door is closed, touch the **LIGHT** key.

## Loading the Wine Racks

### ⚠ WARNING

- Do not pull out more than one loaded shelf at a time as this may cause the wine cellar to tilt forward.
- Do not try to slide the shelves outwards beyond the fixed position to prevent the bottles from falling.
- To prevent damaging the door gasket, make sure the door is fully open when pulling shelves out of the compartment.
- All the wine racks slide out for easy access, except for the bottom shelf. When loading, pull the rack out gently until it stops.
- Each of the slide-out racks can hold up to eight 750 mL Bordeaux bottles.
- The bottom shelf can hold up to six Bordeaux bottles.
- For maximum capacity on the wood racks, reverse the position of every other bottle as shown.



Bottle Placement

- On the bottom shelf, all bottles load with the narrow end out.

# Operating Your Wine Cellar

## Some guidelines for optimum wine storage:

- Fill the cabinet from the bottom up, evenly spreading the wine across all the shelves. Do not overload. Keep small gaps between the walls and the bottles to allow air circulation. Air circulation is important to prevent mould and promotes a more homogeneous temperature.
- Lay the bottles flat.
- Do not cross contaminate. Store only wine in your wine cellar to ensure that the environment is odor free.
- Only store wine in unopened bottles. Storing opened bottles may result in spillage.

## Temperature Alarm

An alarm will sound if the temperature falls outside the set temperature range. The temperature display will flash at the same time. The temperature the appliance is set to determines the temperature the unit recognizes as being too warm or too cool. Once the set temperature has been reached in the appliance, the alarm stops and the relevant temperature display stops flashing.

### The alarm will sound (periodically) and the temperature display will flash:

- When you switch the appliance on, if the temperature inside the appliance is very different from the set temperature.
- When there has been a lengthy interruption to the power supply.
- When too many bottles have been put into the unit at one time.
- When the door is not been closed tightly.

You can disable the audio alarm if you wish by touching the **ON/OFF** key once. The temperature display will continue to flash until the set temperature has been reached.



## Door Alarm

- If the door has been left open for more than 60 seconds, the alarm will sound.
- You can disable the alarm if you wish by touching the **ON/OFF** key once. The alarm will reset when the door is closed.

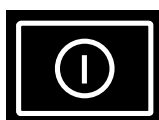

## Dynamic Climate/Silent Mode

Dynamic climate mode distributes the relative humidity and temperature inside the unit evenly through the interior so that all bottles are stored under the same conditions. Dynamic climate mode turns on the interior fan, which circulates the inside air evenly. The unit comes from the factory with dynamic climate mode set to off due to additional energy consumption.

- To change to dynamic climate mode, touch and hold the **DOWN** key for approximately five seconds. The wine cellar will beep to confirm dynamic climate mode is on.
- To change back to silent mode (dynamic climate mode off), touch and hold the **UP** key for approximately five seconds. The wine cellar will beep to confirm silent mode is on.



DOWN Key

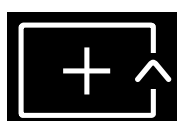

UP key

## Sabbath Mode

Sabbath mode is available for the observance of certain religious holidays. This mode turns off the displays, interior light and audible alarms and prevents them from turning on again. Normal cooling operations will continue to take place.

- To initiate Sabbath mode, touch and hold the **ON/OFF** and **LIGHT** keys at the same time for about 5 seconds.



ON/OFF key

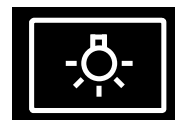

LIGHT key

- The indicator light (dot at the bottom right of the display) will flash four times to confirm the Sabbath mode is on.
- Sabbath mode can be canceled by repeating the above process.
- The Sabbath mode will automatically cancel after 96 hours.

## Energy Saving Tips

- Should the wine cooler be left empty for long periods of time, it is suggested that the appliance is unplugged, and after careful cleaning, leave the door ajar to allow air to circulate inside the cabinet in order to avoid possible condensation, mold or odors forming.
- Only open the door for as long as necessary and for as short a time as possible.

# Care and Cleaning

## **WARNING**

- To avoid possible injury due to electric shock, disconnect the power cord or turn off power at the circuit breaker panel or fuse box before cleaning the appliance.
- Clean only the parts of the appliance listed in this manual. Clean them only in the manner specified.
- Do not use a steam cleaner to clean this appliance. Steam could penetrate the electrical components and cause a short circuit.
- Do not allow water or cleaning fluids to penetrate into the electrical components or ventilation grill.
- Use only the types of cleaning solutions specified in this manual. NEVER clean appliance parts with flammable fluids.
- Do not use abrasives such as steel wool, scouring pads, rough sponges or scrub brushes.

## Defrosting

The compartment of your appliance defrosts automatically. Water may form on the rear wall as part of the defrost process. It drains into a reservoir at the back of the appliance and is heated so that it evaporates.

## Removing Shelves

1. Pull the shelf out until the notches are directly under the plastic rack stops on both sides.
2. Lift the shelf straight up. The notches in the shelf allow it to slide up, between the rack stops.
3. Once the shelf has cleared the rack stops, pull it out of the compartment.
4. Push both slides back into the unit for safety, then close the door.

### **To reinstall the shelves:**

1. Pull the shelf slides out until they stop.
2. Insert the shelf into the unit above the slides. Line the bottom of both notches up with the top of the rack stops.
3. Gently lower the rack down, allowing the rack stops to slide between the notches.
4. With the shelf laying on top of the slides, slowly push in on each slide until the holes on the bottom of the rack slip over the pins on the top of each slide.
5. Once the rack is seated onto both slides, push the rack into place inside the compartment.

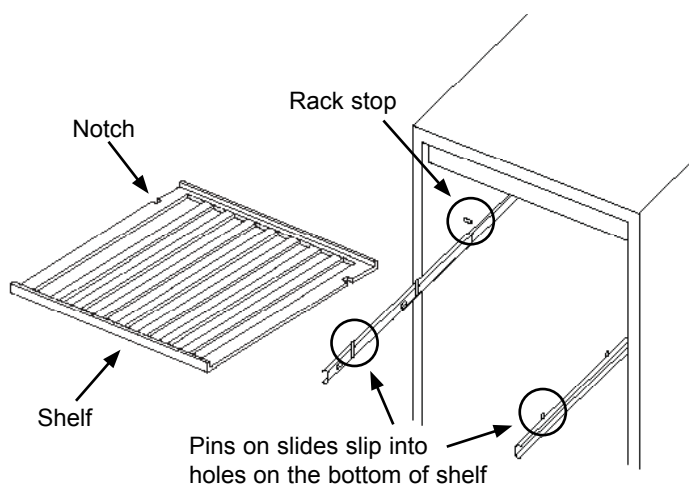

## Cleaning the Surfaces

- To remove finger prints on glass surfaces, use a mild glass cleaner with a soft damp rag.
- Wipe all outside surfaces with a soft dry rag.
- Wipe all inside surfaces, including the control panel, with a soft damp rag. Soak the rag with a mild detergent solution and wring out before use. Remove the shelves when cleaning inside walls.

## When Not In Use

- Removal all bottles.
- Unplug the power plug from the electrical outlet.
- Remove the contents from the wine racks.
- Leave the door open for a few days to clear moisture, blocking it open if necessary.

## When Moving

- Unplug the power plug from the electrical outlet.
- Remove the contents from the wine racks and all moving parts from inside.
- Raise the adjustable legs up to the base to avoid damage.
- Tape the door shut and lock it.
- Transport the wine cellar only in the upright position. Also protect the outside of the appliance with a blanket or similar item.

## Light Replacement

The lights in your wine cellar are LED type and are designed for extremely long life. They are not user serviceable. If they are not working, call your dealer or Dacor Customer Service for service.

## Charcoal Air Filter Replacement

The charcoal air filter is located in the back of the compartment. Replace it with a new one once a year. It can be purchased from your dealer or from [www.everthingdacor.com](http://www.everthingdacor.com).

1. Remove the shelf in front of the filter.
2. Grip the filter and turn it 90° clockwise or counterclockwise to remove.
3. Insert the new filter and turn it clockwise or counterclockwise until it clicks into position.

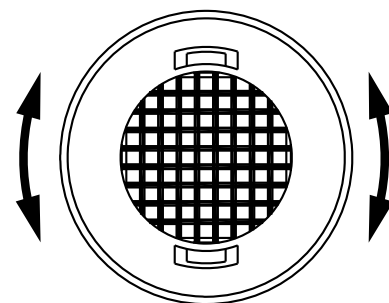



# Specifications and Installation

## Operating Temperature Requirements

Your appliance can operate within the room temperature limits listed below. These temperature limits should not be exceeded.

Room Temperature requirements for proper operation
60°F to 90°F (16°C to 32°C)

## Power Supply Requirements

- This appliance should have its own separate, 110-120 Vac, 15 Amp. grounded circuit controlled by a circuit breaker or fuse.
- Do not connect to a circuit that is turned on and off by a switch.
- Follow the National Electrical Code and local codes and ordinances when installing the electrical outlet. The electrical outlet must be installed by a licensed electrician.
- The electrical outlet must accept a grounded three prong power cord. A ground fault circuit interrupter (GFCI) type is not recommended because it may cause interruption of operation. See **Location Requirements** for guidelines regarding location of the electrical outlet.

Total Connected Load	Circuit Required
1.0 Amp. @ 115 Vac, 60 Hz.	3-Wire, Grounded, Dedicated Circuit 115 Vac @ 15 Amp. 60 Hz.

## Location Requirements

- Operate the appliance only on a solid, stable and level surface. Do not operate on top of carpeting, or other soft surface.
- Locate your wine cellar in a convenient location, away from extreme heat and cold. Locate it away from direct sunlight. The appliance should not be located next to ovens, grills or other sources of high heat. It is suggested that it be located in the coolest area of the room.
- Place your appliance on a floor that is strong enough to support it when it is fully loaded. It weighs 100 lbs (45 kg) unloaded.
- To ensure proper ventilation, the front of the unit must be completely unobstructed. Choose a well ventilated area with temperatures between those stated above. This unit must be installed in an area protected from the elements, such as wind, rain, water spray or drips.
- Optimal spacing for ventilation around the appliance (for maximum efficiency) is 5 inches (12.7cm) in back, at the sides and above. The Dacor wine cellar may be recessed in an opening between cabinets or installed at the end of a cabinet run using a side panel to enclose it. When installing in an enclosed space, the absolute minimum space is 1/4" (5.0 mm) of space on both sides, 1/4" (5.0 mm) of space at the top and 2 1/4" (5.7 cm) in back. See diagram, right.
- The overall height of the appliance can be increased by 2 1/2" (6.4 cm) by adjusting the feet.
- The electrical outlet must be accessible after installation so that the user can unplug the appliance.
- It is advisable to install the appliance with sufficient ventilation in a dry and/or an air-conditioned place to avoid condensation build up on the door during period of high humidity.

## Installation

### **⚠ WARNING**

This appliance must be installed in accordance with all local codes and ordinances.

1. Remove all exterior and interior packing. Clean the interior surface with lukewarm water using a soft cloth. The unit may have residual odors at first, they will disappear as the unit cools.
2. **IMPORTANT:** Before connecting the wine cellar to the power source, let it stand upright for approximately 2 hours. This will reduce the possibility of a malfunction in the cooling system caused by handling during transport.
3. Protect the floor surface before you un-crate the unit. Put the unit on cardboard, plywood or preferably, a carpet remnant (backing up) placed on the floor.
4. Adjust the appliance height if necessary to fit the cutout using the four adjustable feet on the underside of the appliance. Make sure all four feet hit the floor and that the appliance does not rock.
5. Place a level on one of the racks inside the appliance. Check to make sure the appliance is level front to back and side to side. Readjust the feet if necessary.
6. Slide the appliance into the cutout. Keep the floor protected when moving it. Make sure that the power cable does not become trapped.

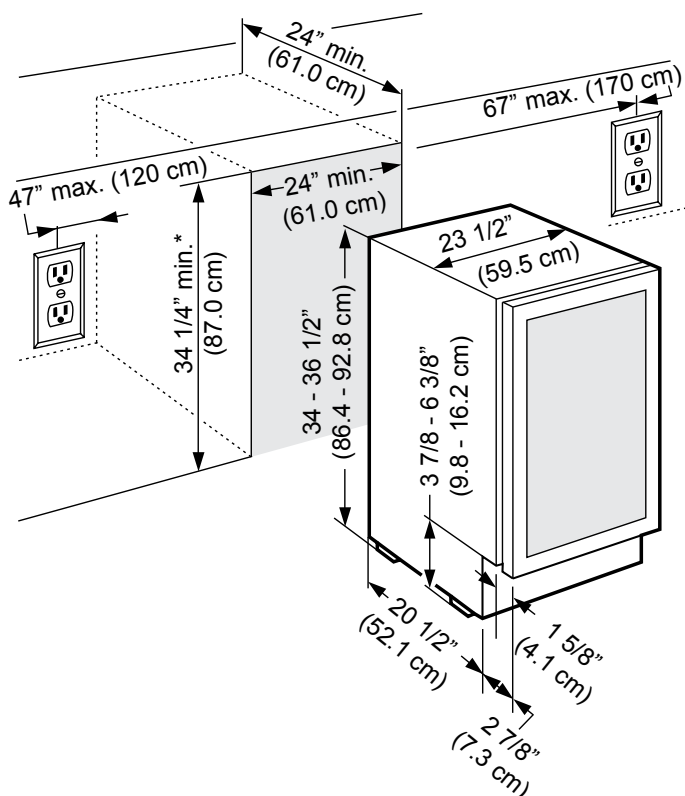

All specifications subject to change without notice.

# Before You Call for Service

## Problem Solution Guide

Problem	May be caused by	What to do
Nothing works. Appliance does not cool, control panel display is off and light does not work.	Appliance not connected to electrical power.	Make sure appliance is plugged in.
	Electricity to power outlet is off.	Turn power on at the circuit breaker panel or fuse box. Check for tripped circuit breaker or blown fuse.
	Appliance is turned off.	See <b>Turning the Power On and Off</b> on page 4.
	Compressor reset delay.	The unit has a compressor reset delay circuit designed to protect the compressor when it is warm. When the compressor is warm, the reset delay prevents the unit from restarting for 3 to 5 minutes. If the unit will not start, disconnect the power cord for 5 minutes, then reconnect.
	Power outage.	Contact power company.
Light does not come on.	No power.	See <b>Nothing works</b> above.
	Light is turned off.	See <b>Interior Lighting</b> on page 4.
	Light malfunctioning.	Call for service to have it replaced. See <b>Getting Help</b> .
Unusual noises.	Bottles vibrating.	Adjust bottles and racks to minimize vibration.
	Appliance not standing firmly on floor.	Check appliance leveling according to <b>Installation</b> section. If problem persists, contact installer. Have installer level appliance or modify installation.
	Object(s) have fallen behind the unit and are causing vibration.	Pull unit out and check for objects that have fallen behind it.
Appliance runs constantly.	Room temperature too hot.	Make sure room temperature is not too hot. See <b>Operating Temperature Requirements</b> on page 7. Adjust ventilation system if necessary.
	Door has been left ajar or opened too often.	Make sure door is firmly shut. Do not open the door unless necessary.
	Appliance mounted too close to heat source.	Have a technician or installer modify the appliance installation or the heat source.
	A lot of bottles added to appliance.	The appliance will run until it has had a chance to cool all the bottles.
Temperature not cold enough.	Temperature not set properly.	See <b>Setting the Temperature</b> on page 4.
	A lot of bottles added to appliance or appliance just turned on.	Appliance will run until it has had a chance to cool all the bottles.
	Door opened too often or left open.	Leave door closed to allow unit to cool inside.
	Ambient room temperature too high	The operating temperature for this appliance is 60°F (16°C) to 90°F (32°C).
	Poor air flow around wine cellar.	Check to make sure that adequate room for air flow has been provided on the sides, top and back. See <b>Installation</b> section on page 7.
	Vents dirty or blocked.	Clean vents on front and back of appliance.
	See <b>Appliance runs constantly</b> , above.	
Condensation on outside surfaces of glass door.	High humidity climate.	During periods of high humidity, some condensation may appear on outside surfaces of glass door. It will disappear when humidity levels drop. It is advisable to install the appliance with sufficient ventilation in a dry and/or an air-conditioned place.
Door will not open.	Door locked.	See page 3.

# Before You Call for Service

Problem	May be caused by	What to do
The door will not close properly.	Appliance not level.	Level the appliance. See <b>Installation</b> section.
	The gasket is dirty.	Clean the door gasket. See <b>Care and Cleaning</b> section.
	The shelves are not properly seated.	Re-seat Shelves. See <b>Care and Cleaning</b> section.
Alarm sounds and temperature display <b>NOT</b> flashing (door alarm).	Door has been left open longer than 60 seconds.	Close door, or touch <b>POWER</b> key to disable alarm. Alarm will reset when door is closed.
Alarm sounds <b>AND</b> temperature display flashes (temperature alarm).	Door being opened too often.	Keep door closed.
	Vent on front of unit is blocked or dirty.	Remove blockage or clean vent. See <b>Care and Cleaning</b> section.
	Long power interruption.	Keep door closed and allow unit to cool to set temperature.
	A large number of bottles have been added to the unit.	Keep door closed and allow unit to cool to set temperature.
"--" (straight line) appears on the display.	Temperature display is out of the range.	Only temperatures within the range of 16 to 99°F (-9 to 37°C) can be displayed. Keep door closed and allow unit to cool to set temperature.
Vibrations.	Appliance not level.	Level the appliance. See <b>Installation</b> section.
The appliance seems to make too much noise.	A rattling noise may come from the flow of the refrigerant, which is normal. Gurgling sounds may be caused by the flow of refrigerant in your appliance, which is normal. If temperature fluctuations occur, the contraction and expansion of the inner walls may cause popping and cracking noises, which is normal.	
	Appliance not level.	Level the appliance. See <b>Installation</b> section.
<b>E0, E1, E2, E3, E4, E5, E6 or E7</b> appears on the display.	Error codes.	Try resetting the controls by disconnecting power to the unit for 5 minutes, then reconnect. If error code returns, problem cannot be resolved by user. Call for service.
Door will not open.	Door locked.	See page 3.
The door will not close properly.	Appliance not level.	Level the appliance. See <b>Installation</b> section.
	The gasket is dirty.	Clean the door gasket. See <b>Care and Cleaning</b> section.
	The shelves are not properly seated.	Re-seat Shelves. See <b>Care and Cleaning</b> section.

# Warranty

## Getting Help

Before you request service:

- Review the **Before You Call for Service** section.
- Use the helpful tips found in the **Problem Solution Guide**.
- Become familiar with the **Warranty** terms and conditions of your product, below.
- If none of these tips or suggestions resolves your problem, call our Customer Service center at one of the numbers shown.

Dacor's Customer Service center is available  
6:00 A.M. - 5:00 P.M. Pacific Time.

**For warranty repairs or questions and for Dacor Distinctive Service (DDS) in the US and Canada:**

Phone: (800) 793-0093, extension 2822

**For non-warranty repairs or questions in the US and Canada:**

Phone: (800) 793-0093, extension 2813

**Contact us through our web site at:**

[www.dacor.com/contact-us](http://www.dacor.com/contact-us)

## What Is Covered

**CERTIFICATE OF WARRANTIES  
DACOR REFRIGERATORS**

**WITHIN THE FIFTY STATES OF THE U.S.A., THE DISTRICT OF COLUMBIA, AND CANADA:**

### FULL ONE YEAR WARRANTY

The warranty applies only to the Dacor appliance sold to the first use purchaser, starting from the date of original retail purchase or closing date for new construction, whichever period is longer. Warranty is valid on products purchased brand new from a Dacor Authorized Dealer or other seller authorized by Dacor.

If your Dacor product fails to function within one year of the original date of purchase due to a defect in material or workmanship, Dacor will remedy it without charge to you.

Except as noted above, consumable parts such as filters are not covered and are the responsibility of the purchaser.

### LIMITATIONS OF COVERAGE

Service will be provided by a Dacor designated service company during regular business hours. Please note service providers are independent entities and are not agents of Dacor.

Dealer display and model home display products with a production date greater than 5 years, products sold "As Is," and products installed for non-residential use, which include but not limited to religious organizations, fire stations, bed and breakfast, and spas carry a one year parts warranty only. All delivery, installation, labor costs and other service fees are the responsibility of the purchaser.

The owner must provide proof of purchase or closing statement for new construction upon request. All Dacor products must be accessible for service. All cosmetic damage (such as scratches on stainless steel, paint/porcelain blemishes, etc.) to the product or included accessories must be reported to Dacor within 60 days of the original purchase date to qualify for warranty coverage.

Warranty will be null and void on product that has altered, defaced, or missing serial numbers and tags.

**OUTSIDE THE FIFTY STATES OF THE U.S.A., THE DISTRICT OF COLUMBIA, AND CANADA:**

### LIMITED FIRST YEAR WARRANTY

If your Dacor product fails to function within one year of the original date of purchase due to a defect in material or workmanship, Dacor will furnish a new part, F.O.B. factory to replace the defective part.

All delivery, installation, labor costs and other service fees are the responsibility of the purchaser.

## What Is Not Covered

- Slight color variations may be noticed because of differences in painted parts, kitchen lighting, product placement and other factors; this warranty does not apply to color variation.
- Service calls to educate the customer on proper use and care of the product.
- Service fees for travel to islands and remote areas, which include but are not limited to, ferries, toll roads or other travel expenses.
- Consequential or incidental damage, including but not limited to food or medicine loss, time away from work or restaurant meals.
- Failure of the product when used for commercial, business, rental or any application other than for residential consumer use.
- Failure of the product caused by improper product installation.
- Replacement of house fuses, fuse boxes or resetting of circuit breakers.
- Damage to the product caused by accident, fire, flood, power interruption, power surges or other acts of God.
- Liability or responsibility for damage to surrounding property including cabinetry, floors, ceilings and other structures or objects around the product.
- Breakage, discoloration or damage to glass, metal surfaces, plastic components, trim, paint or other cosmetic finish caused by improper usage, care, abuse or neglect.

## Out of Warranty

Should you experience a service issue beyond the standard warranty period, please contact us. Dacor reviews each issue and customer concern to provide the best possible solution based on the circumstances.

---

THE REMEDIES PROVIDED FOR IN THE ABOVE EXPRESS WARRANTIES ARE THE SOLE AND EXCLUSIVE REMEDIES. THEREFORE, NO OTHER EXPRESS WARRANTIES ARE MADE, AND OUTSIDE THE FIFTY STATES OF THE UNITED STATES, THE DISTRICT OF COLUMBIA AND CANADA, ALL IMPLIED WARRANTIES, INCLUDING BUT NOT LIMITED TO, ANY IMPLIED WARRANTY OF MERCHANTABILITY OR FITNESS FOR A PARTICULAR USE OR PURPOSE, ARE LIMITED IN DURATION TO ONE YEAR FROM THE DATE OF ORIGINAL PURCHASE. IN NO EVENT SHALL DACOR BE LIABLE FOR INCIDENTAL EXPENSE OR CONSEQUENTIAL DAMAGES. NO WARRANTIES, EXPRESS OR IMPLIED, ARE MADE TO ANY BUYER FOR RESALE.

Some states do not allow limitations on how long an implied warranty lasts, or do not allow the exclusion or limitation of inconsequential damages, so the above limitations or exclusions may not apply to you. This warranty gives you specific legal rights, and you may also have other rights that vary from state to state.

# Notes

# Notes

fold here



NO POSTAGE  
NECESSARY  
IF MAILED  
IN THE  
UNITED STATES

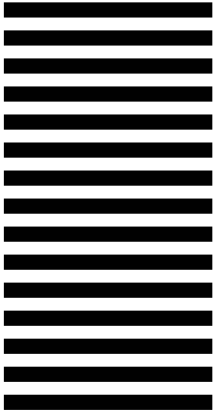

**BUSINESS REPLY MAIL**

FIRST-CLASS MAIL PERMIT NO 1600 CITY OF INDUSTRY CA

POSTAGE WILL BE PAID BY ADDRESSEE

**DACOR  
ATTN WARRANTY PROCESSING DEPT  
PO BOX 90070  
CITY OF INDUSTRY CA 91715-9907**





Please visit [www.dacor.com](http://www.dacor.com) to activate your warranty online.

# WARRANTY INFORMATION



### IMPORTANT:

Your warranty will not be activated until you activate it online or return this form to Dacor. If you have purchased more than one Dacor product, please return all forms in one envelope or activate the warranty for each product online.

Please rest assured that under no conditions will Dacor sell your name or any of the information on this form for mailing list purposes. We are very grateful that you have chosen Dacor products for your home and do not consider the sale of such information to be a proper way of expressing our gratitude!

Owner's Name: \_\_\_\_\_  
Last (Please Print or Type) First Middle

Street: \_\_\_\_\_

City: \_\_\_\_\_ State: \_\_\_\_\_ Zip: \_\_\_\_\_

Purchase Date: \_\_\_\_\_ Email: \_\_\_\_\_ Telephone: \_\_\_\_\_

Dealer: \_\_\_\_\_

City: \_\_\_\_\_ State: \_\_\_\_\_ Zip: \_\_\_\_\_

Your willingness to take a few seconds to fill in the section below will be sincerely appreciated. Thank you.

1. How were you **first** exposed to Dacor products? (Please check one only.)

- A. T.V. Cooking Show
- B. Magazine
- C. Appliance Dealer Showroom
- D. Kitchen Dealer Showroom
- E. Home Show
- F. Builder
- G. Architect/Designer
- H. Another Dacor Owner
- I. Model Home
- J. Other \_\_\_\_\_

2. Where did you buy your Dacor appliances?

- A. Appliance Dealer
- B. Kitchen Dealer
- C. Builder Supplier
- D. Builder
- E. Other \_\_\_\_\_

3. For what purpose was the product purchased?

- A. Replacement **only**
- B. Part of a Remodel
- C. New Home
- D. Other \_\_\_\_\_

4. What is your household income?

- A. Under \$75,000
- B. \$75,000 – \$100,000
- C. \$100,000 – \$150,000
- D. \$150,000 – \$200,000
- E. \$200,000 – \$250,000
- F. Over \$250,000

5. What other brands of appliances do you have in your kitchen?

- A. Cooktop \_\_\_\_\_
- B. Oven \_\_\_\_\_
- C. Dishwasher \_\_\_\_\_
- D. Refrigerator \_\_\_\_\_

6. Would you buy or recommend another Dacor product?

- Yes
- No

Comments: \_\_\_\_\_

Thank you very much for your assistance. The information you have provided will be extremely valuable in helping us plan for the future and giving you the support you deserve.



cut here