



## Operating and Installation Instructions Washer



To prevent accidents and appliance damage, read these instructions **before** installation or use.

# Contents

---

<b>Caring for the environment</b> .....	6
<b>IMPORTANT SAFETY INSTRUCTIONS</b> .....	7
<b>Guide to the washer</b> .....	12
Control panel .....	12
Operating the sensor buttons.....	13
Display .....	14
Examples on how to operate the appliance .....	14
<b>Environmentally friendly washing</b> .....	15
<b>Before using for the first time</b> .....	16
Removing the protective film and stickers .....	16
Miele@home .....	17
1. Setting the display text.....	18
2. Setting up Miele@home .....	18
3. Removing the shipping struts .....	19
4. Starting the calibration program.....	19
<b>1. Prepare the laundry</b> .....	20
<b>2. Selecting a program</b> .....	21
<b>3. Loading the washing machine</b> .....	23
<b>4. Selecting program settings</b> .....	24
Selecting a temperature/spin speed .....	24
Selecting an extra option.....	24
 EcoFeedback .....	24
 Level of soiling.....	25
 Delay start/SmartStart .....	25
<b>5. Adding detergent</b> .....	27
Detergent dispenser drawer .....	27
Dispensing aids.....	27
Using chlorine bleach.....	28
Using powder detergent.....	28
Using detergent tablets or pods.....	28
Using fabric softener and liquid starch .....	29
CapDosing.....	29
<b>6. Start the program - Program end</b> .....	32

<b>Spin cycle</b> .....	33
Final spin speed in the wash program .....	34
Rinse-spin .....	34
Omitting the final spin (Rinse hold).....	34
Deselecting the rinse-spin and final spin .....	34
<b>Program guide</b> .....	35
<b>Extra options</b> .....	41
Pre-wash .....	41
Buzzer.....	41
Extra options can be selected using the “Options” sensor button .....	42
Gentle.....	42
ExtraRinse .....	42
The following extra options can be selected in addition to the programs .....	43
<b>Changing the program sequence</b> .....	44
Canceling a program .....	44
Interrupting a program.....	44
Changing the program .....	44
Child lock.....	45
Adding or removing laundry .....	45
<b>Detergent</b> .....	46
Miele-recommended detergents .....	46
General detergent recommendations.....	47
<b>Cleaning and care</b> .....	48
Cleaning the drum (Hygiene info) .....	48
Cleaning the housing and control panel.....	48
Cleaning the detergent dispensing drawer .....	48
Cleaning the water inlet filter .....	51
<b>Frequently Asked Questions</b> .....	52
A wash program cannot be started.....	52
The following fault message appears in the display and the program has been canceled .....	53
A message appears in the display at the end of the program or when the appliance is switched on.....	54
General problems with the washer.....	55
Poor wash results .....	57
The drum door cannot be opened .....	58
Opening the door in the event of a blocked drain outlet and/or power outage ....	59

# Contents

---

<b>Technical Service</b> .....	61
Contact in case of fault .....	61
Optional accessories.....	61
Warranty .....	61
<b>Installation</b> .....	63
Front view .....	63
Rear view.....	64
Installation surface .....	65
Transporting the washing machine to its installation site.....	65
Removing the shipping struts .....	65
Refitting the shipping struts .....	67
Leveling the machine.....	68
Unscrewing and adjusting the feet.....	68
Additional installation requirements .....	69
Installing under a countertop.....	69
Setting up the cabinet .....	69
For closets at room height.....	70
Product Dimensions .....	70
Dimensions.....	70
Installation on a plinth .....	71
Washer-dryer stack .....	71
The water protection system.....	72
Water intake .....	73
Water drainage .....	74
Electrical connection.....	75
<b>Technical data</b> .....	76
<b>Settings</b> .....	77
Calling up settings.....	77
Selecting settings.....	77
Changing a setting .....	77
Closing the Settings menu .....	77
Language  .....	78
Buzzer volume .....	78
Keypad tone .....	78
Welcome tone .....	78
Code.....	78
Unit.....	79
Brightness .....	79
Display switch-off.....	80
Program info.....	80
Memory .....	80

Water intake .....	80
Long p-wash Normal.....	81
Soak duration .....	81
Gentle action .....	81
Temp. reduction.....	81
Maximum rinse level.....	82
Suds cooling.....	82
Low water pressure .....	82
Anti-Crease.....	82
Miele@home .....	83
Remote control.....	84
SmartGrid .....	84
RemoteUpdate .....	85
Running a RemoteUpdate.....	85
Bleach .....	86
<b>Optional accessories .....</b>	<b>87</b>
Detergent.....	87
Speciality detergents.....	87
Fabric care.....	88
Additive .....	88
Machine care.....	88

# Caring for the environment

---

## Disposal of the packing material

The cardboard box and packing materials protect the appliance during shipping. They have been designed to be biodegradable and recyclable.

Ensure that any plastic wrappings, bags, etc. are disposed of safely and kept out of the reach of children. Danger of suffocation!

## Disposal of your old appliance

Electrical and electronic appliances contain valuable materials. They also contain certain substances, compounds and components which were essential for the proper functioning and safe use of the equipment. Handling these materials improperly by disposing of them in your household waste can be harmful to your health and the environment. Therefore, please do not dispose of your old appliance with regular household waste and follow local regulations on proper disposal.



Consult with local authorities, dealers or Miele in order to dispose of and recycle electrical and electronic appliances. Miele assumes no responsibility for deleting any personal data left on the appliance being disposed. Please ensure that your old appliance is kept away from children until removal. Observe safety requirements for appliances that may tip over or pose an entrapment hazard.

# IMPORTANT SAFETY INSTRUCTIONS

## WARNING

To reduce the risk of fire, electric shock or injury to persons while using your appliance follow basic safety precautions, including the following:

- ▶ Read all instructions before using the appliance.

## ▶ GROUNDING INSTRUCTIONS

This appliance must be grounded. In the event of a malfunction or breakdown, grounding will reduce the risk of electric shock by providing a path of least resistance for electric current. This appliance is equipped with a cord having an equipment-grounding conductor and a grounding plug. The plug must be plugged into an appropriate outlet that is properly installed and grounded in accordance with all local codes and ordinances.

- ▶ **WARNING** - Improper connection of the equipment-grounding conductor may result in a risk of electric shock. Check with a qualified electrician if you are in doubt as to whether the appliance is properly grounded.

- ▶ Do not modify the plug provided with the appliance - if it will not fit the outlet, have a proper outlet installed by a qualified electrician.

- ▶ Do not install or use a washer with visible damage.

- ▶ Do not install or store this appliance where it will be exposed to the weather.

- ▶ Do not install your washing machine where temperatures below freezing may occur. Frozen hoses may burst under pressure. The reliability of the electronic control unit may be impaired at temperatures below freezing.

## IMPORTANT SAFETY INSTRUCTIONS

---

- ▶ Before connecting the machine, ensure that the connection data on the data plate (fusing, voltage and frequency) match the mains electrical supply. If in doubt contact an electrician.
- ▶ Do not use an extension cord to connect this appliance to the power supply. Extension cords do not guarantee the required safety of the appliance (e.g. danger of overheating).
- ▶ This appliance is not designed for maritime use or for use in mobile installations such as recreational vehicles or aircraft. However, under certain conditions it may be possible for an installation in these applications. Please contact the Miele Technical Service Dept. with specific requirements.
- ▶ Do not repair or replace any part of the appliance or attempt any servicing unless specifically recommended in these operating instructions.
- ▶ If the power cord is damaged it must only be replaced by a Miele Service technician with a genuine Miele power cord.
- ▶ Under certain conditions, hydrogen gas may be produced in a hot water system that has not been used for 2 weeks or more. **HYDROGEN GAS IS EXPLOSIVE.** If the hot water system has not been used for such a period, turn on all hot water faucets and let the water flow from each for several minutes before using the washing machine. This will release any built-up hydrogen gas. Do not smoke or use an open flame during this time, the gas is flammable.
- ▶ Before the appliance is removed for service or discarded, remove the door.

# IMPORTANT SAFETY INSTRUCTIONS

---

## Use

- ▶ Do not allow children to play on or in the appliance. Close supervision is necessary when the appliance is used near children.
- ▶ The drum door glass will be hot when washing at very high temperatures. Do not touch the glass. Danger of burns! Keep children away from the washer when in use.
- ▶ Only use the washing machine to wash items which are specified by the manufacturer to be machine washable on the fabric care label. Any other applications may be dangerous.
- ▶ Do not wash articles that have been previously cleaned, washed, soaked or spotted with gasoline, dry-cleaning solvents or other flammable substances. These articles give off vapors that could ignite or explode. Do not add these items to the wash load.
- ▶ Do not add gasoline, dry-cleaning solvents, or other flammable or explosive substances to the wash water. These substances give off vapors which could ignite or explode.
- ▶ Do not use cleaning solvents on or near the machine or the controls. Contact with cleaning solvents will damage the surface..
- ▶ Do not reach into the appliance if the drum is moving.
- ▶ Do not tamper with the controls.

## SAVE THESE INSTRUCTIONS

## IMPORTANT SAFETY INSTRUCTIONS

---

- ▶ Miele tumble dryers and Miele washing machines can be installed as a washer-dryer stack. A Miele washer-dryer connection kit is required as an optional accessory for this. Please ensure that the washer-dryer connection kit is suitable for the Miele tumble dryer and the Miele washing machine.
- ▶ If installing the machine on a Miele plinth (available as an optional accessory), please make sure you order the correct one for this washing machine.
- ▶ Should detergent enter the eyes, rinse out immediately with plenty of lukewarm water. If accidentally ingested, seek medical advice immediately. People who have sustained damage to the skin or who have sensitive skin should avoid contact with the detergent.
- ▶ Be careful when opening the door following use of the steam function. There is a danger of burning due to escaping steam and the high temperature of the surface of the drum as well as the port-hole glass. Step back and wait until the steam has dissipated.
- ▶ The maximum dry laundry weight is 17.6 lb (8 kg). See the “Program guide” for the maximum recommended loads for individual programs.
- ▶ This washing machine is supplied with a special lamp to cope with particular conditions (e.g., temperature, moisture, chemical resistance, abrasion resistance, and vibration). This special lamp must only be used for the purpose for which it is intended. It is not suitable for room lighting. Replacement lamps may only be fitted by a Miele authorized person or by Miele Technical Service.

# IMPORTANT SAFETY INSTRUCTIONS

---

## **FCC Declaration of Conformity**

▶ These devices comply with FCC Rules Part 15. This equipment has been tested and found to be in compliance with the limits for a Class B digital device, pursuant to Part 15 of the FCC Rules of Operation and is subject to the following conditions:

These devices may not cause harmful interference.

These devices must accept any interference received, including interference that may cause undesired operation.

## **FCC Radiation Exposure Statement**

▶ This equipment complies with FCC radiation exposure limits set forth for an uncontrolled environment. This equipment should be installed and operated with minimum distance 8" (20 cm) between the radiator and your body.

## **Industry Canada Statement**

▶ This digital apparatus does not exceed the Class B limits for Radio Noise Emissions from digital apparatus set out in the Radio Interference Regulations of the Canadian Department of Communications.

Complies with Canadian ICES-003 Class B specifications.

# Guide to the washer

## Control panel

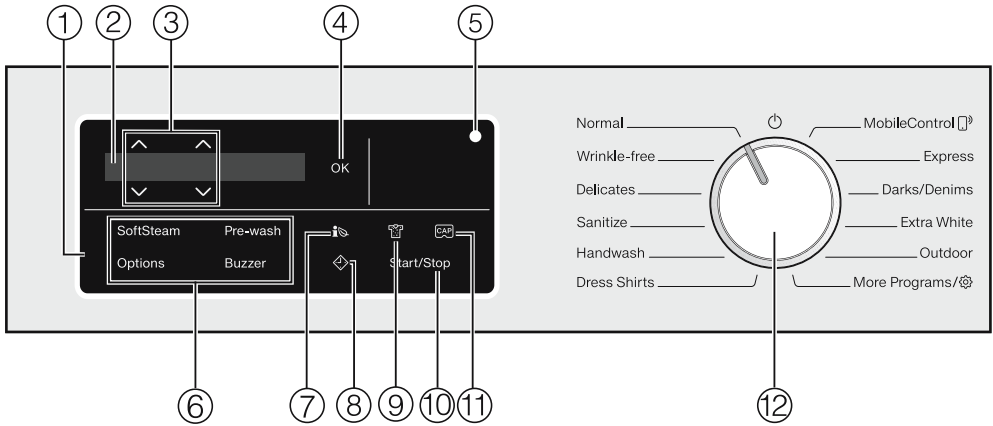

### ① Control field

The control field consists of a display and various sensor buttons. The individual sensor buttons are explained in the following sections.

### ② Display

The following values are displayed and/or selected on the display:

1. The temperature, spin speed, and time left for the selected wash program.
2. The individual values of the selection lists for extras and settings.

### ③ Sensor buttons $\wedge \vee$

The values in the display can be changed with the  $\wedge \vee$  sensor buttons. The  $\wedge$  sensor button increases the value or moves the selection list up; the  $\vee$  sensor button decreases the value or moves the selection list down.

### ④ OK sensor button

Confirm the selected values with the OK sensor button.

### ⑤ Optical interface

This is used by the Service department as a transmission point.

### ⑥ Sensor buttons for extra options

You can supplement the wash programs with extra options. If a wash program has been selected, the sensor buttons for the possible extras light up dimly.

### ⑦ Sensor button $i$

You can use the  $i$  sensor button to call up an energy and water consumption forecast for the selected wash program.

### ⑧ Sensor button $\diamond$

The sensor button  $\diamond$  starts the delay start function. With the delay start function, you can delay the start of the program. The start of the program can be delayed from 15 minutes up to a maximum of 24 hours.

Please see “Delay start” for more information.

## 9 Sensor button

You can specify the level of soiling of the load in three settings.

-  Light
-  Normal
-  Heavy

The wash program changes depending on which level of soiling is selected.

## 10 Start/Stop sensor button

Touching the *Start/Stop* sensor button starts the selected program or cancels a program that has already been started. The sensor button flashes slowly as soon as it is possible for a program to be started and then lights up constantly after the program has started.

## 11 Sensor button

Activate detergent dispensing with a capsule by using the sensor buttons.

## 12 Program selector

For selecting programs and for switching off. The washing machine is switched on when you select a program, and switched off by turning the program selector to the  position.

## Operating the sensor buttons

The sensor buttons react to fingertip contact. Selection is possible as long as the respective sensor button is lit dimly.

If a sensor button is dimly lit, this means: selection possible

If a sensor button is brightly lit, this means: currently selected

# Guide to the washer

## Display

The standard display shows the following values from left to right:



- The selected wash temperature
- The selected spin speed
- The program duration

## Examples on how to operate the appliance

### Scrolling through a list

The  scroll bar in the display indicates that a selection is available.



The list scrolls down when the  $\nabla$  sensor button is touched. The list scrolls up when the  $\blacktriangle$  sensor button is touched. The *OK* sensor button is used to activate the option in the display.

### Identifying the selected option



An activated option in a list will have a check mark  $\checkmark$  next to it.

## Setting numerical values



The numerical value is highlighted in white. Touching the  $\nabla$  sensor button decreases the value. Touching the  $\blacktriangle$  sensor button increases the value. The *OK* sensor button is used to activate the value in the display.

### Leaving a sub-menu

Select *Back*  to exit a sub-menu.

# Environmentally friendly washing

---

## Energy and water consumption

- Make use of the maximum load of the respective wash program. The energy and water consumption will then be the lowest in relation to the size of the load.
- When smaller amounts of laundry are washed, the washing machine's automatic load control system will reduce the amount of water and energy used.
- Use the *Express* program for small, lightly soiled loads.
- Modern detergents make it possible to wash at lower temperatures (e.g., 70°F/20°C). Using the corresponding temperature settings will save energy.
- Washing at low temperatures and/or using liquid detergents can cause bacteria and odors to build up in the washing machine. Miele therefore recommends cleaning the washing machine once every month.

The washing machine provides you with a reminder with the message Sanitize info: Run a high temp. program or the "Clean Machine" program in the display.

## Detergent consumption

- Do not exceed the amounts of detergent recommended on the packaging.
- Adjust the dosage to the level of soiling of the laundry.
- Reduce the amount of detergent with smaller loads (approx. ⅓ less than the amount recommended can be used when washing a half load).
- Only use highly efficient detergent with the following label:



## When drying with a tumble dryer

Select the highest possible spin speed for the wash program to save energy in the subsequent tumble dryer cycle.

## Before using for the first time

 Damage from incorrect installation and connection.

Installing and connecting the washing machine incorrectly will cause serious damage to property.

See “Installation”.

### Removing the protective film and stickers

■ Remove:

- The protective film from the door
- Any stickers (if present) from the front and the lid

Please do not remove any labels (e.g., the data plate) which are visible when you open the door.

This washing machine has undergone a complete functional test at the factory and some residual water will therefore remain in the drum from this process.

### Remove the drain hose elbow from the drum

An elbow piece for the drain hose is stored in the drum.



- Pull open the door.
- Remove the elbow piece.

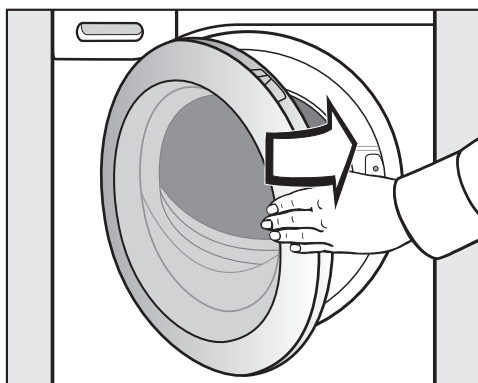

- Shut the door.

# Before using for the first time

## Miele@home

Your washing machine is equipped with an integrated WiFi module.

To use this feature, you will need:

- A WiFi network
- The Miele@mobile app
- A Miele user account. The user account can be created via the Miele@mobile app.

The Miele@mobile app will guide you as you connect your washing machine to your home WiFi network.

Once your washing machine is connected to your WiFi network, you can use the app, for example, to carry out the following activities:

- Operate your washing machine remotely
- Access information about the operating status of your washing machine
- Access information about a program sequence on your washing machine

Connecting your washing machine to your WiFi network will increase energy consumption, even when the washing machine is switched off.

Before installing the washing machine in its final location, ensure the signal strength is sufficient for your WiFi network.

## Availability of the WiFi connection

The WiFi connection shares a frequency range with other appliances (including microwave ovens and remote control toys). This can cause sporadic or even complete connection failures. Therefore, the availability of featured functions cannot be guaranteed.

## Miele@home availability

The ability to use the Miele@mobile app depends on the availability of the Miele@home service in your country.

The Miele@home service is not available in every country.

For information about availability, please visit [www.miele.com](http://www.miele.com).

## Miele@mobile App

The Miele@mobile App is available to download free of charge from the Apple App Store® or from the Google Play Store™.



# Before using for the first time

---

## Switching on the washing machine

- Turn the program selector to the *Normal* program.

The welcome tone will sound and the welcome screen will light up.

The display will guide you through the **4 steps** of the initial commissioning.

## 1. Setting the display text

You are requested to set the display language. It is possible to change the language at any time by setting the program selector to the *Additional programs*/⚙️ position in the *Settings* ⚙️ sub-menu.



- Touch the v/^ sensor buttons until the language you want appears in the display.
- Confirm your language selection by touching the *OK* button.

## 2. Setting up Miele@home

The following message appears in the display:

**i** Miele@home

- Confirm with *OK*.

The following message appears in the display:

Set up now

- To set up Miele@home now: Touch the *OK* sensor button.
- To postpone setup: Touch the v sensor button until the following appears in the display: *Set up later* and press the *OK* button to confirm.

The following selection options appear in the display:

1. Connect via WPS
2. Connect via App

- Select the required connection type.

You will then be guided by the display and the Miele@mobile app.

### 3. Removing the shipping struts

 Damage resulting from failure to remove the transit bars.

Failure to remove the shipping struts can result in damage to the washing machine and to adjacent cabinetry or appliances.

Remove the shipping struts as described in "Installation and connection".

The following message appears in the display:

 Remove shipping struts

■ Confirm with the *OK* sensor button.

### 4. Starting the calibration program

For optimum water and energy consumption and excellent wash results, it is important to calibrate the washing machine.

To do this, the *Normal* program **must** be run without laundry and without detergent.

No other programs can be started until calibration has been carried out.

The following message appears in the display:

Open  and run "Normal" with "Hot Plus" without laundry.

■ Touch the  $\nabla$  sensor button until the *OK* sensor button lights up and confirm this with *OK*.



■ Turn on the water supply.

■ Touch the *Start/Stop* sensor button.

The washing machine calibration program has started. It will take approximately 2 hours.

At the end of the program the following message will appear in the display:

 Set up complete

# 1. Prepare the laundry

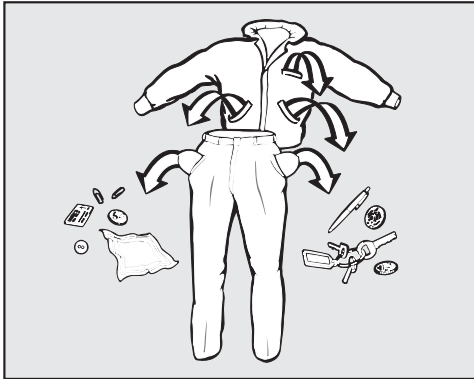

- Empty all pockets.

**⚠** Damage due to foreign objects. Nails, coins, paper clips, and so on can cause damage to garments and components in the machine. Check the laundry before washing and remove any such foreign objects.

## Sort the laundry

Only wash items that are labeled machine washable by the manufacturer. Most garments have a fabric care label in the collar or side seam.

- Sort the laundry by care label and color.

**Tip:** Dark fabrics often bleed the first few times they are washed. They should be washed separately several times before being included in a mixed load.

## Pre-treating stains

- Badly soiled areas and stains should be cleaned as soon as possible, preferably while still fresh. Stains should be carefully dabbed off using a soft, colorfast cloth. Do not rub!

**Tip:** Stains (such as blood, egg, coffee, and tea) can be pre-treated using some handy tricks which can be found in the Miele guide to laundry care. Please contact Miele directly or submit a request via Internet page to obtain or view a copy of this manual.

**⚠** Damage due to solvent-based cleaning agents  
Cleaning agents containing benzene, stain remover, etc., can damage plastic parts.  
When pre-treating a stain, make sure that plastic parts do not come into contact with cleaning agents.

**⚠** Risk of explosion due to solvent-based cleaning agents.  
When using solvent-based cleaning agents, an explosive mixture may develop.  
Never use solvent-based cleaning agents in the washing machine.

## General tips

- Curtains: Remove any lead weights or strips before washing.
- Loose bra underwires should be removed or sewn in place before washing.
- Close zippers, hooks and eyelets before washing.
- Comforter covers and pillowcases should be fastened to prevent small items from rolling inside of them.

Do not wash items with the  symbol on the fabric care label.

## 2. Selecting a program

### Switching on the washing machine

- Turn the program selector to a program.

The interior drum lighting will come on.

The drum lighting will go out automatically after five minutes.

### Switching on the drum lighting again

- Close and open the door.

### Program selection

There are three possible ways to select a program:

#### 1. Selecting the standard programs with the program selector dial

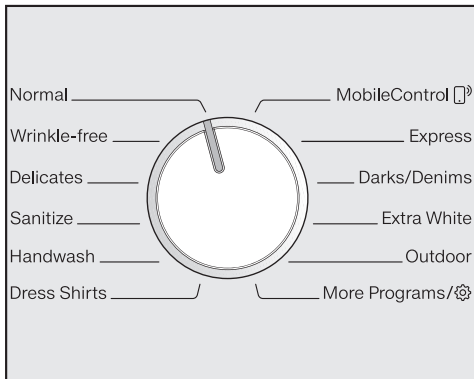

- Turn the program selector to the required program.

The selected program will be shown in the display. This will then be replaced by the standard display.

#### 2. Selecting additional programs by setting the program selector to the “More programs/gear” position and the display:

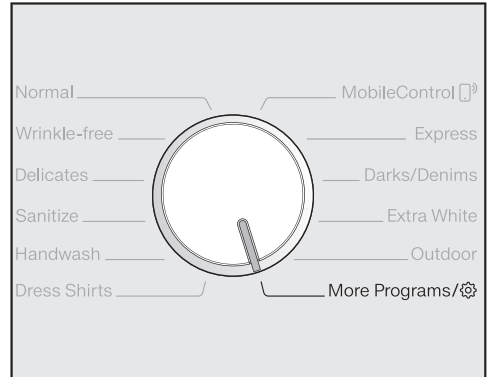

- Turn the program selector to the *More programs/gear* position.

The following appears in the display:

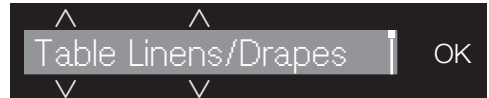

- Touch the ∨∧ sensor buttons until the program you want appears in the display.
- Confirm the program with the *OK* sensor button.

Preset program parameters will be displayed, depending on the program selected.

## 2. Selecting a program

---

### 3. Selecting the programs via the MobileControl program selector position and the Miele@mobile app

**Tip:** In order to use MobileControl , the washing machine must be logged on to the WiFi network and the Remote control must be switched on.

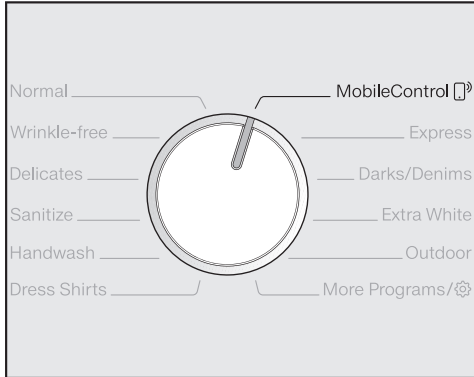

- Turn the program selector to the *MobileControl*  position.

The following appears in the display:  
 Load laundry, close the door and press "Start". Appliance can be remotely controlled

- Follow the instructions in the display and start the program.

The following appears in the display:  
 MobileControl 

The washing machine can now be operated with the Miele@mobile app.

### 3. Loading the washing machine

#### Opening the door



- Take hold of the door and pull it open.

Check the drum for pets or foreign objects before loading it with laundry.

The most efficient use of energy and water is achieved when a full load is washed. However, do not overload as this reduces cleaning efficiency and causes creasing.

- Unfold the laundry and load loosely in the drum.

Mixing both large and small items gives better wash results and also helps distribute the load evenly during spinning.

**Tip:** Please note the maximum load for different wash programs.

#### Closing the door

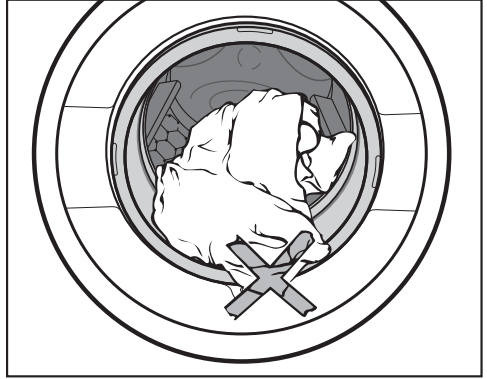

- Make sure that no items are caught between the door and the seal.

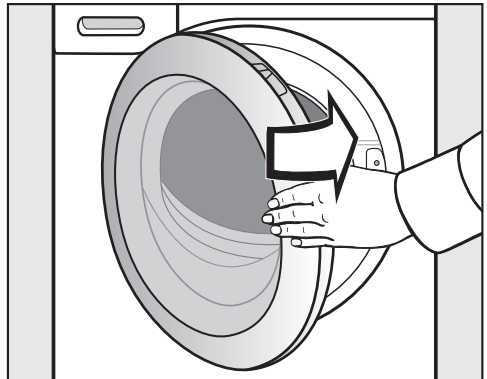

- Shut the door with a gentle swing.

## 4. Selecting program settings

### Selecting a temperature/spin speed

You can alter the preset temperature/spin speed of a wash program if this is permitted by the program.



- Touch the  $\nabla/\Delta$  sensor buttons above or below the temperature or spin speed value in the display until the temperature/spin speed you want appears in the display. Confirm with the OK sensor button.

### Selecting an extra option

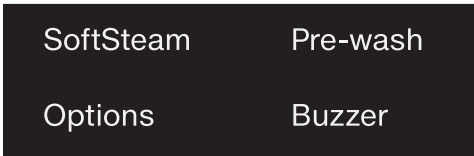

- Touch the sensor button for the extra you want. It then lights up brightly.

**Tip:** You can select multiple extras for a wash program.

Not all the extra options can be used with every program. If an extra option is not dimly lit, this option is not permitted for the wash program (see “Extra options”).

### Extras sensor button

You can select additional extras using the Extras sensor button.

- Touch the *Extras* sensor button.

The following appears in the display:



- Touch the  $\nabla/\Delta$  sensor buttons until the extra option you want appears in the display.
- Confirm the extra option with the OK sensor button.

### EcoFeedback

You can use the  sensor button to call up an energy and water consumption forecast for the selected wash program.

- Touch the  sensor button.

The estimated energy and water consumption levels will be displayed as a bar chart.

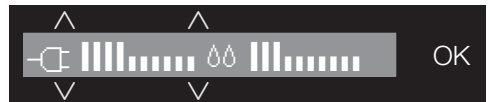



The more bars visible (▮), the higher the energy or water consumption.

- Touch the OK sensor button or wait until the display automatically returns to the standard display.

## 4. Selecting program settings

### Level of soiling

You can specify the level of soiling of the load.

-  Light  
No visible soiling or stains
-  Normal  
Visible soiling and/or a small number of light stains visible
-  Heavy  
Soiling and/or stains clearly visible. A pre-wash is automatically carried out

The following parameters will change, depending on the level of soiling selected:

- With the  Heavy level of soiling setting, a pre-wash will be carried out automatically (see “Options”).
- The adjustment of the rinse water level

### Delay start/SmartStart

#### Delay start

With the delay start function, you can delay the start of the program.

This function is active when the setting SmartGrid is switched off.

The hours can be set in the values from 00 to 24. The minutes can be set in 15-minute increments from 00 to 45.

#### Setting the delay start time

- Touch the  sensor button.

The following will appear in the display:



- Set the hours with the  $\nabla/\wedge$  sensor buttons. Confirm with the *OK* sensor button.

The display will change:



- Set the minutes with the  $\nabla/\wedge$  sensor buttons. Confirm with the *OK* sensor button.

**Tip:** The values will count upwards and downwards automatically if you keep your finger on the  $\nabla/\wedge$  sensor buttons.

#### Changing delay start

The selected delay start time can be changed before the program start.

- Touch the  sensor button.
- If desired, change the specified time and confirm with the *OK* sensor button.

## 4. Selecting program settings

### Canceling delay start

The selected delay start time can be canceled before the program start.

- Touch the  sensor button.

The selected delay start time will appear in the display.

- Set a time value of 00:00 h with the  $\nabla$   $\blacktriangle$  sensor buttons. Confirm with the OK sensor button.

The selected delay start time has been canceled.

After the program start, the selected delay start time can only be changed or canceled by interrupting the program.

### SmartStart

The SmartStart function lets you define a time period during which your washing machine will start automatically. The start takes place via a signal, e.g., from your energy supplier, that indicates that the electricity rate is particularly economical. Please check with your local utility provider for availability.

This function is active when the Smart-Grid setting is switched on.

The time period can be defined between 15 minutes and 24 hours. During this period, the washing machine waits for the signal from the energy supplier. If no signal is sent during the defined period, the washing machine starts the wash program.

### Setting the timeframe

If you have activated the SmartGrid function in Settings, SmartStart instead of Start in will appear in the display when you touch the  sensor button (see “Settings – SmartGrid”).

The procedure for setting this is the same as for setting the time for delay start.

- Use the  $\nabla$   $\blacktriangle$  sensor buttons to enter the hour and confirm your entry with the OK sensor button.

The hour will be saved and the minute numerical keypad will be highlighted.

- Use the  $\nabla$   $\blacktriangle$  sensor buttons to enter the minutes and confirm your entry with the OK sensor button.

- Press the *Start/Stop* sensor button to start the wash program with SmartStart.

The following will appear in the display:



## 5. Adding detergent

There are several options for adding detergent to the washing machine.

### Detergent dispenser drawer

This washing machine requires high efficiency detergent. Adhere strictly to the dispensing amounts supplied by the detergent manufacturer. The detergents must be marked with the following label:



### Filling with detergent

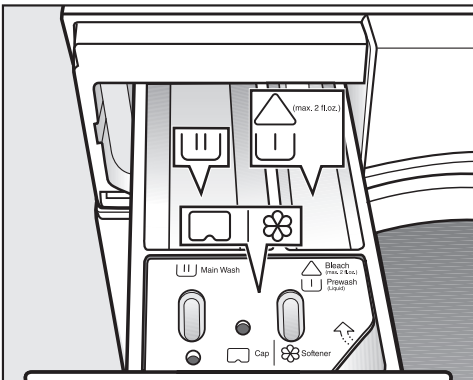

- Pull out the detergent drawer and add detergents to the compartments.

- △ Chlorine bleach for removing stains or liquid detergent for the pre-wash
- Detergent for the main wash and soaking
- ⊗ Fabric softener, liquid starch, or capsules

### Tips for dispensing

Adjust the detergent dosage to the level of soiling of the laundry and the maximum load. Reduce the amount of detergent with smaller loads (e.g., reduce the amount of detergent by  $\frac{1}{3}$  when washing a half load).

### Too little detergent:

- The laundry is not cleaned properly and may become gray and hard to the touch over time.
- Can lead to a build-up of mould in the washing machine.
- Grease is not completely removed from the laundry.
- Can lead to limescale deposits on the heater elements.

### Too much detergent

- Poor wash, rinse, and spin results.
- Causes higher water consumption as an extra rinse cycle is automatically activated.
- A greater burden on the environment.

### Dispensing aids

Use dispensing aids (e.g., balls) if these are supplied with the detergent, particularly when using liquid detergent.

## 5. Adding detergent

### Using chlorine bleach

 Damage due to chlorine bleach. Textiles may be discolored or their fibers damaged. Only use chlorine bleach on suitable textiles.

Chlorination **must** be activated in the settings before chlorine bleach is first used.

### Chlorine bleach may be used in the following programs:

- Normal
- Wrinkle-free
- Sanitize
- Dress Shirts
- Extra White
- Table Linens/Drapes

### Dispensing chlorine bleach

Follow the manufacturer's instructions on the packaging.



The extra option *pre-wash* must **not** be selected.

- Pour **max. ¼ cup (60 ml)** of chlorine bleach into the   chamber.

The chlorine bleach is added automatically 10 minutes before the end of the main wash.

### Using powder detergent

The detergent dispenser drawer contains an insert for liquid detergent in the  compartment. This insert must be removed to use powder detergent.

It is **not possible** to use powder detergent in the   compartment.

A pre-wash cannot be carried out when using powder detergent.

- Remove the detergent dispenser drawer.
- Remove the insert for liquid detergents from the  compartment.

**Tip:** Reinsert the insert into the detergent dispenser drawer before next using liquid detergent.

### Using detergent tablets or pods

**Always** put detergent tablets or pods directly in the drum with the laundry. They cannot be added via the detergent dispenser drawer.

## 5. Adding detergent

### Using fabric softener and liquid starch

#### Fabric softeners

make garments soft to handle and help prevent static cling when tumble drying.

#### Liquid starch

is synthetic and provides good stiffness to fabric.

#### Natural starch

stiffens and gives body to fabric.

### Adding fabric softener

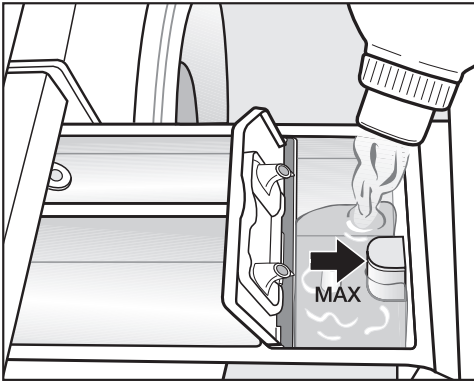

- Add the fabric softener or the liquid starch to the ☼ compartment. **Do not exceed the maximum level mark.**

It will be automatically dispensed in the final rinse cycle. At the end of the program, a small amount of water remains in the ☼ compartment.

If starching frequently, clean the dispenser compartment, especially the siphon, regularly.

### CapDosing

Three different types of capsule are available:

- ☼ = Fabric care (e.g., fabric softener, proofing agent)
- ☼ = Additives (e.g., detergent enhancers)
- ☼ = Detergent (for the main wash only)

Each capsule contains the correct amount for one wash cycle.

Capsules are available to order from Miele's online store, Miele customer service, or your Miele dealer.

⚠ Capsules pose a health risk. The ingredients of capsules can be hazardous to health if they are swallowed or come into contact with skin. Keep capsules out of the reach of children.

### Activating CapDosing

- Touch the  sensor button.

The following appears in the display:



- Touch the  sensor buttons until the capsule you want appears in the display.
- Confirm the capsule with the OK sensor button.

## 5. Adding detergent

### Inserting a capsule

- Open the detergent dispenser drawer.

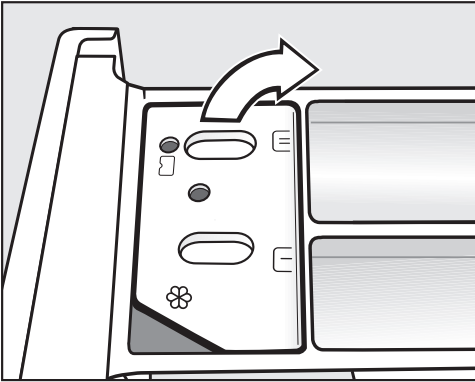

- Open the lid of the ☸/☐ compartment.

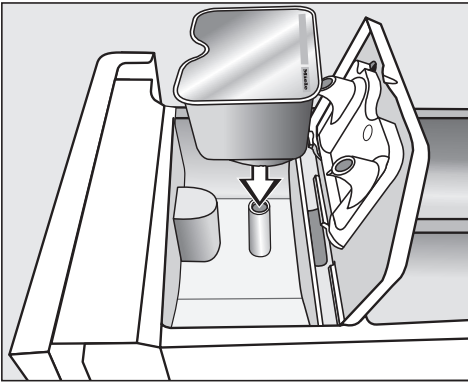

- Press the capsule in firmly.

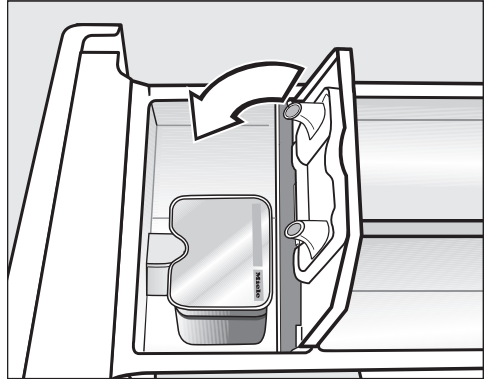



- Close the lid and press it firmly shut.
- Close the detergent dispenser drawer.

The capsule is opened by the act of inserting it in the detergent dispenser drawer. The contents can run out of the capsule if you then remove it from the drawer before it is used. Dispose of opened capsules.

## 5. Adding detergent

The contents of the capsule will be added to the wash program at the correct time.

During CapDosing, water intake to the  compartment takes place solely via the capsule.

Do not add any additional fabric softener to the  compartment.

- Remove the empty capsule at the end of the wash program.

For technical reasons, a small amount of water will remain in the capsule.

### Deactivating or changing CapDosing

CapDosing can only be deactivated or changed prior to program start.

- Touch the  sensor button.
- Select No Cap (deactivate) or a different type of capsule (change).

### Dyes / dye removers

 **Do not use** dye removers in this washer!

The use of dyes in the washer is recommended only to a degree of usual household use. The salt used for dying may corrode the stainless steel with frequent use.

Use only as directed by the manufacturer.

## 6. Start the program - Program end

### Starting a program

- Touch the flashing *Start/Stop* sensor button.

The door will lock (🔒 will appear in the display to show this) and the wash program will start.

If a delay start time has been selected, then this will count down in the time display. At the end of the delay start time or immediately after the program has started (if no delay start time has been selected), the program duration will appear in the time display.

### Energy savings

After 10 minutes, the indicators dim. The *Start/Stop* sensor button will light up, flashing.

You can reactivate the indicators:

- Touch the *Start/Stop* sensor button (this does not have any effect on a running program).

The drum lighting switches off once the program has started.

### Program end

The door is still locked during the Anti-crease phase and the following will appear alternately in the display:



and



- Touch the *Start/Stop* sensor button. The door will be unlocked.

- Pull open the door.
- Remove the laundry.

Items left in the drum could discolor other items in the next wash or become discolored themselves. Remove all items from the drum.

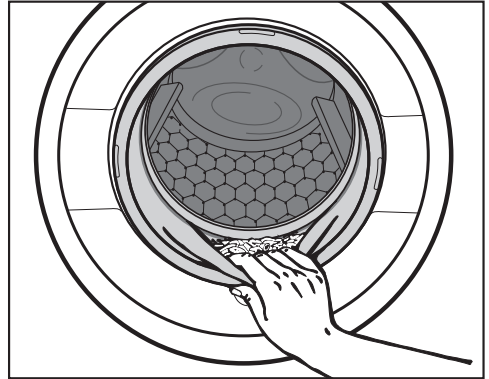

- Check the folds in the door seal for any foreign objects.





**Tip:** Leave the door slightly open to allow the drum to dry.

- Turn the program selector to the ⏻ position. This switches the washing machine off.

- If applicable, remove the used capsule from the detergent dispenser drawer.

**Tip:** Leave the detergent dispenser drawer slightly open to allow it to dry.

## Final spin speeds

Program	Selectable spin speeds in words and numbers					
	Max 1600 rpm	High 1200 rpm	Med 800 rpm	Slow 600 rpm		 0 rpm
Normal	✓	-	-	-	X	X
Wrinkle-free	-	✓	X	X	X	X
Delicates	-	-	✓	X	X	X
Sanitize	✓	X	-	-	X	X
Handwash	-	✓	X	X	X	X
Dress Shirts	-	-	✓	X	X	X
Express	-	✓	X	X	X	X
Darks/Denims	-	✓	X	X	X	X
Extra White	✓	X	-	-	X	X
Outdoor	-	-	✓	X	X	X
Table Linens/Drapes	-	✓	X	X	X	X
Sportswear	-	✓	X	X	X	X
Woolens 	-	X	✓	X	X	X
Silks 	-	-	-	✓	X	X
Proofing	-	X	✓	X	X	X
Drain/Spin	✓	X	X	X	-	X
Separate rinse	✓	X	X	X	X	X
Clean Machine	-	-	-	✓	-	-

✓ = optimum spin speed for program is pre-set

X = can be selected      - = cannot be selected

# Spin cycle

---

## Final spin speed in the wash program

When a program is selected, the optimum spin speed for the wash program is always shown in the display.

A faster spin speed can be selected for certain wash programs.

The highest selectable spin speed is indicated in the table.

## Rinse-spin

There is a spin cycle after the main wash and between the rinse cycles. A reduction in the final spin speed will also reduce the interim spin speed as appropriate.

## Omitting the final spin (Rinse hold)

If Rinse hold is selected, the laundry remains in the water following the final rinse cycle. This helps prevent creasing if the laundry is not going to be removed from the drum immediately after the end of the program.

- Set the spin speed  (0 rpm).

## To start the final spin:

The washing machine will display the maximum spin speed possible. You can reduce the spin speed.

- Touch the *Start/Stop* sensor button.

## Ending the wash program

Use if you want to remove the laundry when it is dripping wet and without spinning.

- Reduce the spin speed to  (0 rpm).
- Touch the *Start/Stop* sensor button.

The water will be pumped away.

## Deselecting the rinse-spin and final spin

- Before the start of the wash program, reduce the spin speed to  (0 rpm).
- Touch the *Start/Stop* sensor button.

After the last rinse cycle, the water will be pumped away and the anti-crease phase will switch on.











An additional rinse cycle is carried out with this setting for certain wash programs.

## Programs on the program selector





The temperature marked with ✓ is pre-set.

Temperature with garment care label symbols			Item/Tip
<b>Normal</b>			<b>Full load (17.6 lb/8 kg)</b>
Hot +	140°F/60°C		Cotton, linen, and mixed fibre textiles made of both cotton and linen.
Hot	120°F/50°C		
Warm + ✓	105°F/40°C		
Warm	85°F/30°C		
Cold	Cold		
<b>USA test program in accordance with:</b> DOE Federal Register 10 CFR Part 430 Appendix J2 to subpart B <b>Canada test program in accordance with:</b> CAN/CSA-C360-13			
<b>Wrinkle-Free</b>			<b>Half load (8.8 lb/4 kg)</b>
Hot +	140°F/60°C		Synthetic or mixed fibre fabric, or easy care cotton.
Hot	120°F/50°C		
Warm + ✓	105°F/40°C		
Warm	85°F/30°C		
Cold	Cold		
<b>Delicates</b>			<b>Small load (6.6 lb/3 kg)</b>
Hot +	140°F/60°C		For fine textiles made from synthetic fibers.
Hot	120°F/50°C		
Warm + ✓	105°F/40°C		
Warm	85°F/30°C		
Cold	Cold		

# Program guide













Temperature with garment care label symbols		Item/Tip	
<b>Sanitize</b>		<b>Full load (17.6 lb/8 kg)</b>	
Sanitize ✓	170°F/75°C		Cotton or linen fabrics with direct skin contact or for which special hygiene requirements apply.
<b>Handwash</b>		<b>Small load (4.4 lb/2 kg)</b>	
Warm + ✓	105°F/40°C		For fine textiles which are only suitable for hand washing.
Warm	85°F/30°C		
Cold	Cold		
<b>Dress Shirts</b>		<b>Small load (4.4 lb/2 kg)</b>	
Hot +	140°F/60°C		Pre-treat collars and cuffs depending on the level of soiling.
Hot	120°F/50°C		
Warm + ✓	105°F/40°C		Wash silk shirts and blouses in the <i>Silks</i>  program.
Warm	85°F/30°C		
Cold	Cold		
<b>MobileControl</b> 			
The Miele@mobile app is used to select the programs and operate the appliance.			
<b>Express</b>		<b>Half load (7.7 lb/3.5 kg)</b>	
Warm +	105°F/40°C		Cotton textiles that have hardly been worn or are only very lightly soiled.
Warm ✓	85°F/30°C		
Cold	Cold		Selecting the  Light level of soiling will reduce the washing time by 10 minutes.

## Program guide

Temperature with garment care label symbols			Item/Tip
<b>Darks/Denims</b>			<b>Small load</b> (4.4 lb/2 kg)
Warm + ✓	105°F/40°C		Black and dark garments made from cotton, mixed fibers, and denim. – Wash inside out.  – Denim often contains excess dye and may run during the first few washes. Therefore, wash light and colored items separately.
Warm	85°F/30°C		
Cold	Cold		
<b>Extra White</b>			<b>Full load</b> (17.6 lb/8 kg)
Hot + ✓	140°F/60°C		For white textiles made of cotton or linen without special hygiene requirements.
<b>Outdoor</b>			<b>Small load</b> (5.5 lb/2.5 kg)
Warm + ✓	105°F/40°C		Performance outerwear (e.g., jackets and trousers) made from membrane fabric. – Zip up or close any jackets with Velcro before washing.  – Do not use fabric softener.  – If required, these garments can also be re-proofed using the <i>Proofing</i> program. Re-proofing after each wash cycle is not recommended.
Warm	85°F/30°C		
Cold	Cold		

## Program guide

### Programs positioned on the More programs/ program selector

Temperature with garment care label symbols		Item/Tip	
<b>Table Linens/Drapes</b>			<b>Full load (13.2 lb/6 kg)</b>
Hot +	140°F/60°C		Table Linens and drapes made of cotton and linen.
Hot	120°F/50°C		
Warm + ✓	105°F/40°C		
Warm	85°F/30°C		
Cold	Cold		
<b>Sportswear</b>			<b>Half load (6.6 lb/3 kg)</b>
Hot +	140°F/60°C		Sportswear such as jerseys and leggings, as well as microfiber and fleece garments. – Do not use fabric softener. – Observe the manufacturer's care label.
Hot	120°F/50°C		
Warm + ✓	105°F/40°C		
Warm	85°F/30°C		
Cold	Cold		
<b>Woolens</b> 			<b>Small load (4.4 lb/2 kg)</b>
Warm ✓	85°F/30°C		Wool or wool-blend textiles. Reduce the final spin speed for items which crease easily.
Cold	Cold		
<b>Silks</b> 			<b>Very small load (2.2 lb/1 kg)</b>
Warm ✓	85°F/30°C		Silks and other hand-washable textiles with no wool content. Place tights, bras, etc., in a washing bag.
Cold	Cold		

## Program guide

Temperature with garment care label symbols		Item/Tip
<b>Proofing</b>		<b>Small load (5.5 lb/2.5 kg)</b>
Warm + ✓	105°F/40°C	<p>Treating microfiber fabric, ski wear, or Table Linens made from mainly synthetic fibers to provide a finish which is resistant to water and dirt.</p> <ul style="list-style-type: none"> <li>– The items should be freshly laundered and spun or dried before proofing.</li> <li>– For best results, the items should be heat-treated afterwards, either in a tumble dryer or by ironing.</li> </ul>
<b>Drain/Spin</b>		<b>Full load (17.6 lb/8 kg)</b>
		<ul style="list-style-type: none"> <li>– Drain only: Set spin speed to No .</li> <li>– Make sure you select the appropriate spin speed.</li> </ul>
<b>Separate rinse</b>		<b>Full load (17.6 lb/8 kg)</b>
		<p>For rinsing hand-washed items.</p> <p>Reduce the final spin speed for items which crease easily.</p>

# Program guide

---

## Settings /maintenance

### Settings

You can use the settings to alter the washing machine's electronics to suit changing requirements. See “Settings” for more detailed information.

### Maintenance

The washing machine has a maintenance program.

<b>Temperature</b> with garment care label symbols	<b>Item/Tip</b>
<b>Clean Machine</b> <span style="float: right;"><b>Without load</b></span>	
	<p>With frequent washing at low temperatures there is a danger of a build-up of bacteria in the washing machine.</p> <p>Cleaning the washing machine will significantly reduce bacteria and prevent the build-up of unpleasant odors.</p> <ul style="list-style-type: none"><li>– Optimum results can be achieved by using Miele machine cleaner. Alternatively, a universal powder detergent can be used.</li><li>– Dispense the machine cleaner or universal detergent directly into the drum.</li><li>– Do not load machine. The drum must be empty for the maintenance wash.</li></ul>

You can supplement the wash programs with extra options.

## Selecting extra options

Extra options are selected or deselected using the sensor buttons in the control field. Additional extra options can be selected on the display using the *Extras* sensor button.

SoftSteam	Pre-wash
Options	Buzzer

- Touch the sensor button for the extra option you want.

The relevant button will light up brightly.

Not all the extra options can be used with every program.





An extra option that is not permitted for the wash program is not lit dimly and cannot be activated by touch.

## SoftSteam

In order to reduce creasing, the laundry undergoes a smoothing process at the end of the program. Reducing the maximum load by 50% will give a better result.

Without Soft- Steam		With SoftSteam
Full load	→	Half load
Half load	→	Small load
Small load	→	Very small load



Small loads give a better result.



The garments must be suitable for drying in a tumble dryer   and suitable for ironing  .

## Pre-wash

For laundry with large amounts of dirt, e.g., dust and sand.

Pre-wash **cannot** be combined with the use of chlorine bleach. The chlorine bleach is added too early.

Only liquid detergent may be added to the   chamber of the detergent dispenser drawer.

Powder detergent clogs up the   chamber and water can escape from the detergent dispenser drawer.

## Buzzer

A buzzer sounds at the end of the program. The buzzer sounds until the washing machine is switched off. The volume of the buzzer can be changed, see “Settings – Buzzer”.

## Extra options

---

### Extra options can be selected using the “Options” sensor button

#### Selecting extra options in the display

- Touch the *Options* sensor button.
- The first extra option which can be selected appears in the display.
- Touch the  $\vee/\wedge$  sensor buttons until the extra option you want appears in the display.
  - Confirm the extra option with the *OK* sensor button.

The extra option has a  $\checkmark$  next to it.

#### Deselecting an extra option

- Touch the *Options* sensor button.
- The first extra option which can be selected appears in the display.
- Touch the  $\vee/\wedge$  sensor buttons until *No Extras* appears in the display.
  - Confirm *No Extras* with the *OK* sensor button.

The previously selected extra option is now deselected.

### Soak

For heavily soiled textiles with protein stains.

A duration of between 30 minutes and 6 hours can be chosen for the soak process in 30-minute increments. See “Settings” for more information.

The factory default setting is 30 minutes.

### Gentle



Drum rotation and wash duration is reduced. Lightly soiled textiles are washed more gently.

### ExtraRinse

An additional rinse cycle can be activated to give a better wash result.

## Extra options

The following extra options can be selected in addition to the programs

	SoftSteam	Buzzer	Pre-wash	Soak	Gentle	ExtraRinse
Normal	-	X	X	X	X	X
Wrinkle-free	X	X	X	X	X	X
Delicates	X	X	X	X	X	X
Sanitize	X	X	X	X	X	X
Handwash	-	X	-	-	-	-
Dress Shirts	X	X	X	X	X	X
Express	X	X	-	-	-	-
Darks/Denims	X	X	X	X	X	X
Extra White	X	X	X	X	X	X
Outdoor	-	X	X	X	-	X
Table Linens/Drapes	X	X	X	X	X	X
Sportswear	-	X	X	X	-	X
Woolens 	-	X	-	-	-	-
Silks 	-	X	-	-	-	-
Proofing	-	X	-	-	-	-
Drain/Spin	-	X	-	-	-	-
Separate Rinse	X	X	-	-	-	-

**X** = can be selected

**-** = cannot be selected

## Changing the program sequence

---

### Canceling a program

You can cancel a wash program at any time after it has started.

- Touch the *Start/Stop* sensor button.

The following will appear in the display:



- Touch the *OK* sensor button.

The suds will be pumped away. The following will appear in the display:



Wait until the door unlocks.

- Pull open the door.
- Remove the laundry.

### If you want to select a different program

- Close the door.
- Select the desired program.
- Add detergent to the detergent dispenser drawer, if necessary.
- Touch the *Start/Stop* sensor button.

The new program will begin.

### Interrupting a program

- Turn the program selector to the  position.

The washing machine switches off.

- To continue: Turn the program selector to the position of the wash program that was started.

**Tip:** If  *Change not possible* appears in the display, the program selector is in the incorrect position.

### Changing the program

After a program has started, it is no longer possible to select a different program.

# Changing the program sequence

## Child lock

The wash program cannot be interrupted unintentionally.

### Activating the child lock

- Touch the *Start/Stop* sensor button.

The following will appear in the display:



- Scroll up the list with the  $\nabla$  sensor buttons:



- Touch the *OK* sensor button.

### Deactivating the child lock

- Touch the *Start/Stop* sensor button.

The following will appear in the display:



- Touch the *OK* sensor button.

## Adding or removing laundry

Laundry can only be added or removed at the beginning of a wash program.

If the following message no longer appears in the display then it is no longer possible to add items of laundry.

- Press the *Start/Stop* button.

The following will appear in the display:



- Touch the  $\nabla/\wedge$  sensor buttons until the following appears in the display:



- Touch the *OK* sensor button.

The program will stop and the door will unlock.





- Pull open the door.
- Add or remove items.
- Close the door.
- Touch the *Start/Stop* sensor button.

The wash program will continue.

# Detergent

## Miele-recommended detergents

The Miele detergents have been developed by Miele especially for the Miele washing machine. You can order the Miele detergents from Miele's online store or you can purchase them from Miele's customer service, or your Miele dealer.

	Miele UltraWhite	Miele UltraColor	Miele Cap 	Miele Cap 	Miele Cap 
Normal	✓	✓	–	ⓕ	ⓓ
Wrinkle-free	–	✓	–	ⓕ	ⓓ
Delicates	–	✓	ⓐ, ⓑ, ⓒ	ⓕ	–
Sanitize	✓	–	–	ⓕ	ⓓ
Handwash	–	–	ⓑ, ⓓ, ⓔ	ⓕ	–
Dress Shirts	✓	✓	–	ⓕ	ⓓ
Express	–	✓	–	ⓕ	–
Darks/Denims	–	✓	–	ⓕ	–
Extra White	✓	✓	–	ⓕ	ⓓ
Outdoor	–	–	ⓒ	–	–
Table Linens/Drapes	✓	✓	–	ⓕ	ⓓ
Sportswear	–	–	ⓐ	–	–
Woolens 	–	–	ⓓ, ⓔ	–	–
Silks 	–	–	ⓔ	–	–
Proofing	–	–	–	ⓖ	–
Separate Rinse	–	–	–	ⓕ	–

✓ Recommended

– Not recommended

ⓐ Sport

ⓑ Downs

ⓒ Outdoor

ⓓ WoolCare

ⓔ SilkCare



ⓕ Fabric softener

ⓖ Proofing

ⓓ Booster

## General detergent recommendations

The wash programs that are not listed do not have a detergent recommendation.

	Universal detergent	Color detergent	Detergent for Woolens and delicates	Bleach
Normal	✓	✓	-	✓
Wrinkle-free	✓	✓	-	✓
Delicates	-	✓	✓	-
Sanitize	✓	✓	-	✓
Handwash	-	-	✓	-
Dress Shirts	✓	✓	-	✓
Express	-	✓ <sup>1)</sup>	-	-
Darks/Denims	-	✓	✓	-
Extra White	✓	-	-	✓
Outdoor	-	-	✓	-
Table Linens/ Drapes	✓	✓	-	✓
Sportswear	-	-	✓	-
Woolens 	-	-	✓	-
Silks 	-	-	✓	-

✓ Recommended

- Not recommended

<sup>1)</sup> Liquid detergent

## Cleaning and care

### Cleaning the drum (Hygiene info)

Washing at low temperatures and/or using liquid detergents can cause bacteria and odors to build up in the washing machine. Use the *Clean machine* program to clean the machine. Note the message in the display:

Sanitize info: Run a high temp. program or the "Clean Machine" program

### Cleaning the housing and control panel

⚠ Risk of electric shock.

Mains voltage is present when the washing machine is switched off. Disconnect the machine from the electricity supply before cleaning or maintenance.

⚠ Risk of damage due to ingress of water.

The pressure of a water jet can cause water to get into the washing machine, resulting in damage to components.

Do not spray the washing machine with a water jet when hosing down.

- Clean the housing and control panel with a mild cleaning agent or soap and water and dry both with a soft cloth.
- The drum can be cleaned using a suitable stainless steel cleaning agent following the manufacturer's instructions on the packaging.

⚠ Damage due to cleaning agents. Do not use solvents, abrasive cleaners, glass cleaners or all-purpose cleaning agents. These might damage plastic surfaces and other components because of the chemicals they contain. Do not use any of these cleaning agents.

### Cleaning the detergent dispensing drawer

Washing at low temperatures and the use of liquid detergent can lead to a build-up of bacteria in the detergent dispenser drawer.

- For hygiene reasons, clean the entire drawer at regular intervals.

### Removing the detergent dispenser drawer

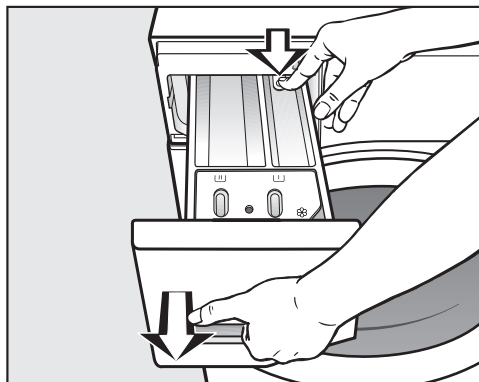

- Pull out the detergent dispenser drawer until a resistance is felt. Press down the release button and at the same time pull the drawer right out of the machine.

## Removing and cleaning the insert for liquid detergents

An insert for liquid detergents is located in the  compartment of the detergent dispenser drawer.

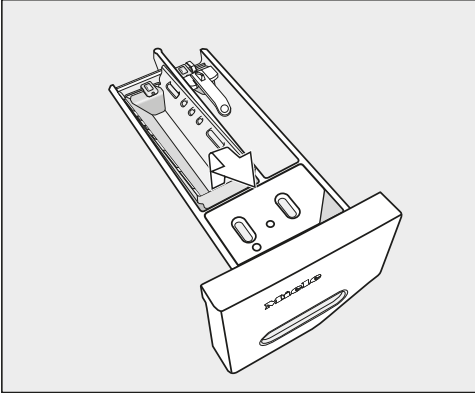

- Remove the insert. Clean the insert thoroughly with warm water.

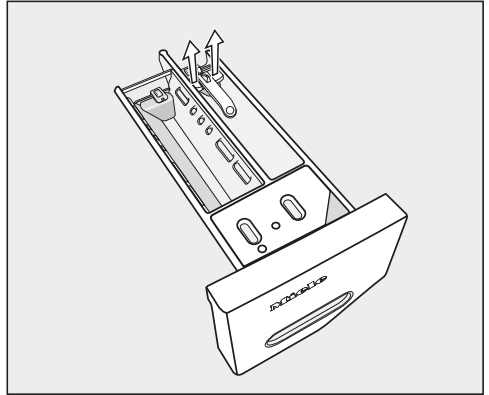

## Cleaning the compartment

Compartment 1 has a siphon for better dispensing of the chlorine bleach.



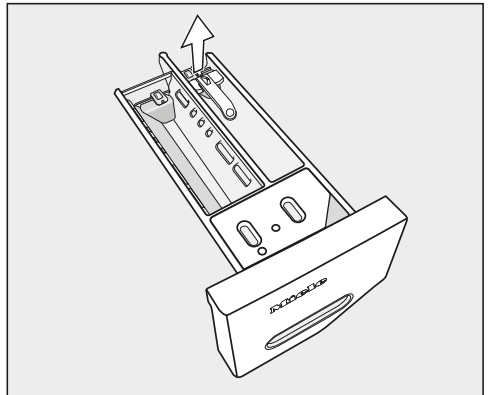

- Remove the release catch.



- Remove and clean the siphon.
- Clean the  and  compartments with warm water.

## Cleaning and care

### Cleaning the siphon and the compartment channel

Liquid starch results in clogging. The siphon in the   compartment no longer works and the compartment can overflow.

Clean the siphon particularly thoroughly after using liquid starch a few times.

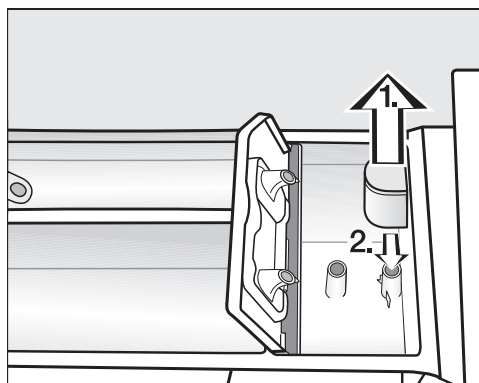

1. Remove the siphon from the  compartment and clean under warm running water. Clean the siphon tube in the same way.
2. Refit the siphon.

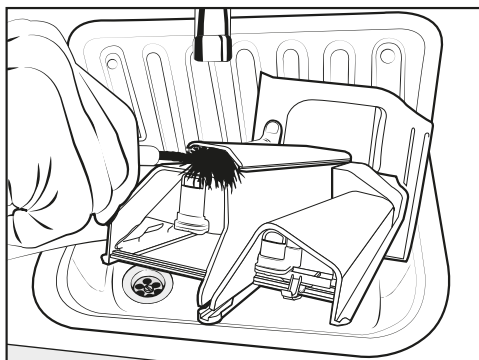

- Clean the fabric softener channel with a brush and warm water.

### Cleaning the detergent dispenser drawer housing

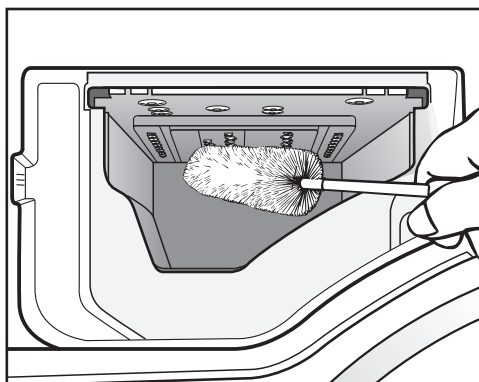

- Use a bottle brush to remove detergent residues and limescale from the jets inside the detergent dispenser drawer housing.
- Replace the detergent dispenser drawer.

**Tip:** Leave the detergent dispenser drawer slightly open to allow it to dry.

## Cleaning the water inlet filter

The washing machine has two filters to protect the inlet valve. You should inspect the filters approximately every six months, or more often if there are frequent interruptions to the external water supply.

### Cleaning the filter in the inlet hose

- First turn off the faucet.
- Unscrew the inlet hose from the faucet.

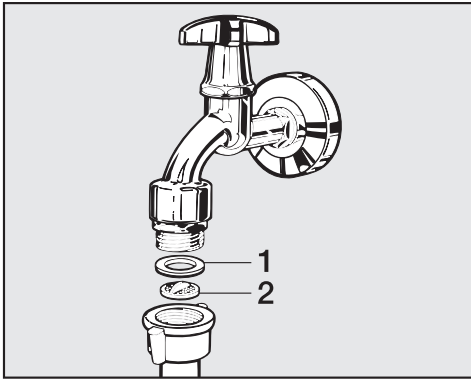

- Remove the rubber seal **1** from the connector.
- Using needle nose pliers, take hold of the plastic filter bar **2** and remove it.
- Clean the filter.
- Reassemble the appliance in reverse order.

### Cleaning the filter in the inlet valve

- Using pliers, carefully loosen the ribbed plastic nut on the inlet valve and unscrew.

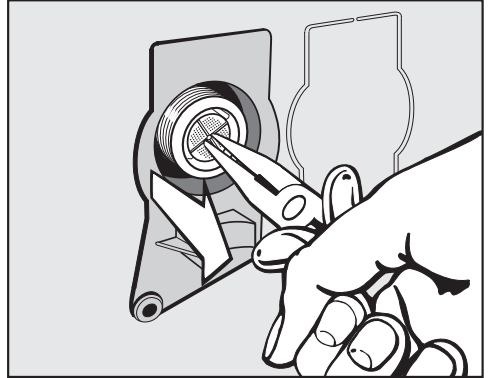

- Use needle nose pliers to withdraw the filter by the bar.
- Clean the filter.
- Reassemble the appliance in reverse order.

After cleaning, turn the faucet slowly and make sure the screw connections are watertight. If water leaks, tighten the screw connections.

The filters **must** be put back in place after cleaning.

## Frequently Asked Questions



---

With the help of the following guide minor faults in the performance of the machine, some of which may result from incorrect operation, can be remedied without contacting the Service Department.

This guide may help you to find the reason for the fault, and how to correct it.







Some of the messages in the display are more than one line long. Touch the √ or ∧ sensor button to read them in full.

### A wash program cannot be started

Problem	Possible cause and solution
<b>The display remains dark, and the Start/Stop sensor button does not light up or flash.</b>	There is no power to the machine. <ul style="list-style-type: none"><li>■ Check whether the plug is plugged in.</li><li>■ Check whether the fuse has tripped.</li></ul>
	The washing machine has switched off automatically to save energy. <ul style="list-style-type: none"><li>■ Turn the program selector to switch the washing machine on again.</li></ul>
<b>The display prompts you to enter a code.</b>	The PIN code is active. <ul style="list-style-type: none"><li>■ Enter the code and confirm the entry. Deactivate the PIN code if you do not wish this message to appear in the display the next time the machine is switched on.</li></ul>
<b>The following appears in the display:</b>   Service Door lock fault F34	The door is not closed properly. The door lock could not engage. <ul style="list-style-type: none"><li>■ Close the door again.</li><li>■ Start the program again.</li></ul> If the fault message appears again, contact the Service department.

## Frequently Asked Questions

The following fault message appears in the display and the program has been canceled

Message	Possible cause and solution
 Water intake See 	The water intake is blocked or restricted. <ul style="list-style-type: none"> <li>■ Check whether the water supply is turned on properly.</li> <li>■ Check whether the intake hose is kinked.</li> <li>■ Check whether there is sufficient water pressure.</li> </ul>
	The filter in the water intake is blocked. <ul style="list-style-type: none"> <li>■ Clean the filter.</li> </ul>
	The drain pump is activated for 2 minutes. The machine door is then released. Wait for the drain pump to stop before switching the machine off.
 Drainage See 	The drain is blocked or restricted. The drain hose has been fixed too high. <ul style="list-style-type: none"> <li>■ Clean the filter and the pump.</li> <li>■ The maximum drain height is 39" (1 m).</li> </ul>
 Service Water-proof syst. 	The water protection system has activated. <ul style="list-style-type: none"> <li>■ Close the faucet.</li> <li>■ Contact the Service department.</li> </ul>
 Service Fault F	There is a fault. <ul style="list-style-type: none"> <li>■ Disconnect the washing machine from the electricity supply, either by withdrawing the plug from the socket or by disconnecting it at the fuse.</li> <li>■ Wait <b>at least 2 minutes</b> before reconnecting the washing machine to the electricity supply.</li> <li>■ Then switch the washing machine on again.</li> <li>■ Restart the program.</li> </ul> If the fault message appears again, contact the Service department.

To switch off the fault indicator: Turn the program selector to the  position and switch the washing machine off.

## Frequently Asked Questions

### A message appears in the display at the end of the program or when the appliance is switched on

Message	Possible cause and solution
<p><b>i</b> Align the washing machine</p>	<p>The smoothing process which the laundry undergoes at the end of the program could not be carried out properly.</p> <ul style="list-style-type: none"> <li>■ Check whether the washing machine is aligned correctly as described in “Installation and connection – Leveling the machine”.</li> <li>■ Check whether the maximum delivery height of 39“ (1 m) has been exceeded.</li> </ul> <p>If the fault message appears again, contact the Service department. The washing machine can still be used but with reduced functionality.</p>
<p><b>i</b> Check dosage</p>	<p>Excessive foam has built up during washing.</p> <ul style="list-style-type: none"> <li>■ Use less detergent next time and follow the manufacturer's instructions on dosage given on the packaging.</li> </ul>
<p><b>i</b> Sanitize info: Run a high temp. program or the "Clean Machine" program</p>	<p>A wash program using a temperature above 140°F (60°C), example <i>Normal/Hot+</i>, has not been run for a long period of time.</p> <ul style="list-style-type: none"> <li>■ Turn the program selector to <i>More programs</i>/.</li> <li>■ Touch the <math>\wedge \vee</math> sensor buttons until Maintenance appears in the display.</li> <li>■ Touch the <i>OK</i> sensor button to confirm.</li> </ul> <p>The following appears in the display: Clean Machine</p> <ul style="list-style-type: none"> <li>■ Touch the <i>OK</i> sensor button to confirm.</li> <li>■ Run the Clean Machine program using the Miele clean machine or a universal powder detergent.</li> </ul> <p>The washing machine is cleaned which prevents bacteria and odor buildup.</p>

The message which appears at the end of the program or when the washing machine is switched on must be confirmed with the *OK* sensor button.



# Frequently Asked Questions

## General problems with the washer

Problem	Possible cause and solution
<b>The washing machine is emitting an odor.</b>	<p>The hygiene info was not observed. A wash program using a temperature above 140°F (60°C) has not been run for a long period of time.</p> <ul style="list-style-type: none"><li>■ In order to prevent bacteria and unpleasant odors building up in the machine, run the <i>Clean machine</i> program using Miele clean machine or universal powder detergent.</li></ul>
	<p>The door and detergent dispenser drawer were closed after washing.</p> <ul style="list-style-type: none"><li>■ Leave the door and the detergent dispenser drawer slightly open to allow them to dry.</li></ul>
<b>The washer shakes during the spin cycle.</b>	<p>The four feet are not resting evenly on the floor.</p> <ul style="list-style-type: none"><li>■ Level the machine (see “Leveling the washer”).</li></ul>
<b>The laundry has not been spun properly and the laundry is still wet.</b>	<p>The machine detected an imbalance during the final spin and reduced the spin speed automatically.</p> <ul style="list-style-type: none"><li>■ Wash large and small items together in order to achieve a more even load distribution.</li></ul>

# Frequently Asked Questions

## General problems with the washing machine

Problem	Possible cause and solution
<b>There are unusual sounds coming from the drain pump.</b>	There is no fault! Lapping sounds at the beginning and end of the drain process are normal.
<b>The fabric softener is not completely dispensed or too much water remains in the compartment.</b> 	The siphon tube is either positioned incorrectly or clogged. ■ Clean the siphon tube, see “Cleaning and care - Cleaning the detergent drawer”.
<b>The display is dark.</b>	The display has switched off automatically to save energy (Standby mode). ■ Press any button. Standby will end.
<b>At the end of the program there is still liquid in the capsule.</b>	The small pipe in the detergent dispenser drawer onto which the capsule is placed is blocked. ■ Clean the small pipe.
	Not a fault. For technical reasons, a small amount of water will remain in the capsule.
<b>There is water next to the capsule in the fabric softener compartment.</b>	The  sensor button was not activated or an empty capsule was not removed at the end of the last wash cycle. ■ Activate the  sensor button when a capsule is next used. ■ Remove and then dispose of the empty capsule at the end of each wash cycle.
	The small pipe in the detergent dispenser drawer onto which the capsule is placed is blocked. ■ Clean the small pipe.
<b>The display shows a foreign language.</b>	The display language was adjusted. ■ Select the display language. See “Setting the display language”.



# Frequently Asked Questions

## Poor wash results

Problem	Possible cause and solution
<b>Liquid detergent is not achieving the required results.</b>	<p>Liquid detergents do not usually contain bleaching agents. Consequently, fruit, coffee, and tea stains cannot always be removed.</p> <ul style="list-style-type: none"><li>■ Use powder detergent containing a bleaching agent.</li><li>■ Use the appropriate capsule or add stain removers to the  compartment.</li><li>■ Never put stain removers and liquid detergent together in the detergent dispenser drawer.</li></ul>
<b>Gray, greasy particles cling to washed laundry.</b>	<p>Insufficient amounts of detergent were used. The laundry was heavily soiled with grease (oils, ointments).</p> <ul style="list-style-type: none"><li>■ Use more detergent or liquid detergent with this type of soiled laundry.</li><li>■ Before washing the next load, run the <i>Clean machine</i> wash program using Miele clean machine or a universal powder detergent.</li></ul>
<b>White residues which look like powder detergent are seen on dark textiles after washing.</b>	<p>The detergent contained compounds (zeolites) to aid water softening which are not soluble in water. These have ended up on the laundry.</p> <ul style="list-style-type: none"><li>■ Try and brush off the residues with a soft brush once the laundry is dry.</li><li>■ In the future, wash dark textiles using a detergent which contains no zeolites. Liquid detergents do not usually contain zeolites.</li><li>■ Use the <i>Darks/Denim</i> program to wash the textiles.</li></ul>

## Frequently Asked Questions

### The drum door cannot be opened

Problem	Possible cause and solution
<p><b>The door cannot be pulled open during a program.</b></p>	<p>The door is locked during a program.</p> <ul style="list-style-type: none"> <li>■ Touch the <i>Start/Stop</i> sensor button.</li> <li>■ Select <i>Cancel Program</i> or <i>Add laundry</i> in the display using the <math>\nabla/\wedge</math> sensor buttons.</li> </ul> <p>The door will unlock and you will be able to pull it open.</p> <hr/> <p>There is still water in the drum and the machine is unable to drain.</p> <ul style="list-style-type: none"> <li>■ Clean the drain filter and the drain pump as described in “Opening the door in the event of a blocked drain outlet and/or power cut”.</li> </ul> <hr/> <p>The water level in the drum is too high.</p> <ul style="list-style-type: none"> <li>■ Cancel the program. The washing machine will pump away the water.</li> </ul>
<p>Comfort Cooling <b>appears in the display after a program has been canceled.</b></p>	<p>To protect the user against scalding, the door cannot be opened if the suds temperature is higher than 130°F (55°C).</p> <ul style="list-style-type: none"> <li>■ Wait until the temperature in the drum has decreased and the message has gone out in the display.</li> </ul>
<p><b>The following appears in the display:</b>    Service Door release fault F35</p>	<p>The door lock has jammed.</p> <ul style="list-style-type: none"> <li>■ Contact the Service department.</li> </ul>

### Opening the door in the event of a blocked drain outlet and/or power outage

- Turn off the washing machine.

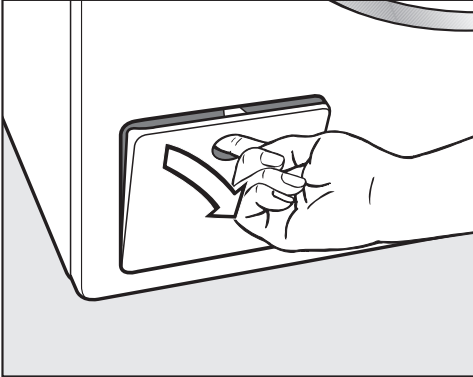

- Open the drain pump flap.

### Blocked drain outlet

If the drain outlet is blocked, a larger quantity of water can remain in the washing machine.

 Risk of scalding due to hot suds. Escaping suds will be hot if laundry has been washed at high temperatures. Carefully allow all suds to drain off.

### Draining the washing machine

Remove the drain filter, though not completely.

- Place a suitable container under the flap, e.g., a bowl or dish.

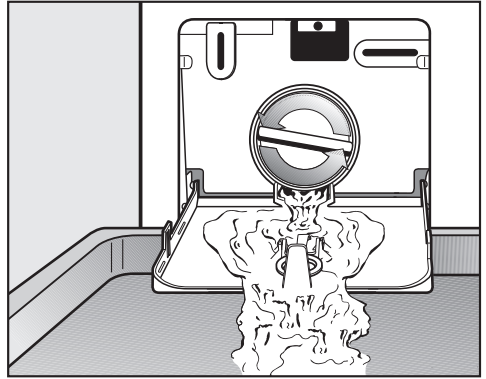

- Slowly unscrew the drain filter to let the water out.
- Tighten the drain filter back up again if you need to interrupt the flow of water.

Once the flow of water stops:

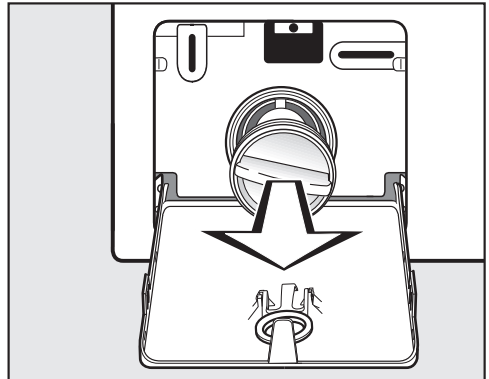

- Remove the drain filter completely.

## Frequently Asked Questions

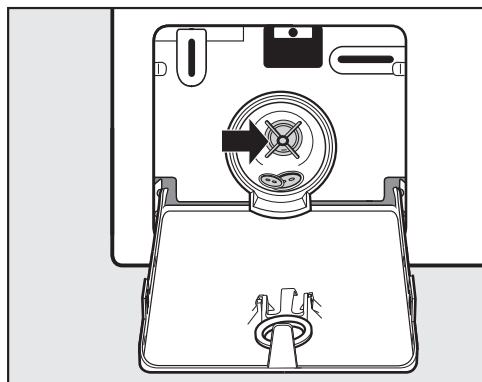

- Clean the drain filter thoroughly.
- Remove any foreign objects (e.g., buttons, coins, etc.) and clean the interior. Turn the impellers by hand to check that they rotate freely.
- Replace the drain filter correctly and tighten it securely.
- Close the drain pump flap.



**Risk of water damage**  
Make sure the drain filter is securely tightened. Otherwise there is a risk of water leakage during use.  
Replace the drain filter correctly and tighten it securely.

### Opening the door



**Danger of injury due to rotating drum.**

Reaching into a rotating drum is extremely dangerous and may result in injury.

Always make sure that the drum is stationary before reaching in to remove laundry.

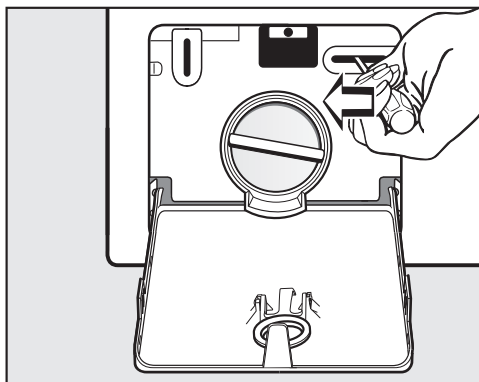

- Use a screwdriver to unlock the door.
- Pull open the door.

## Contact in case of fault

In the event of a fault which you cannot remedy yourself, please contact your Miele dealer or Miele Technical Service.

Contact information for Miele Technical Service can be found at the end of this document.

Please quote the model and serial number of your appliance when contacting Miele. Both pieces of information can be found on the data plate.

The data plate is found above the port-hole glass when the door is opened.

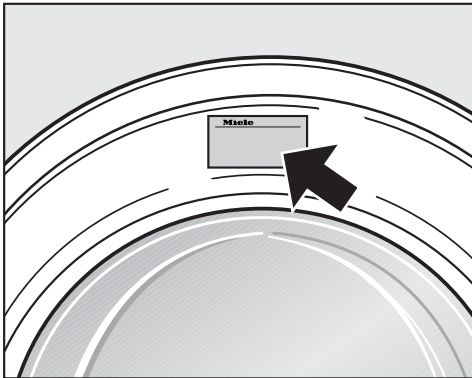

## Optional accessories

Optional accessories are available through your Miele dealer or Miele.

## Warranty

For further information, please refer to your warranty booklet.

## Installation instructions

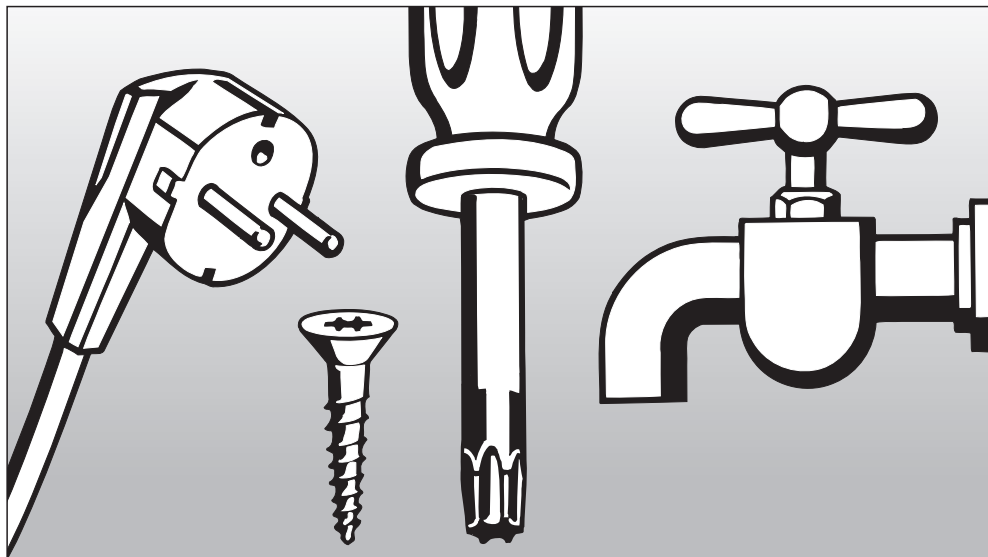

Alteration rights reserved.

Visit our website for all the current product specifications, technical appliance information, and warranty information.

To avoid accidents or damage to the appliance, please read these instructions before installing and/or using it.

## Front view

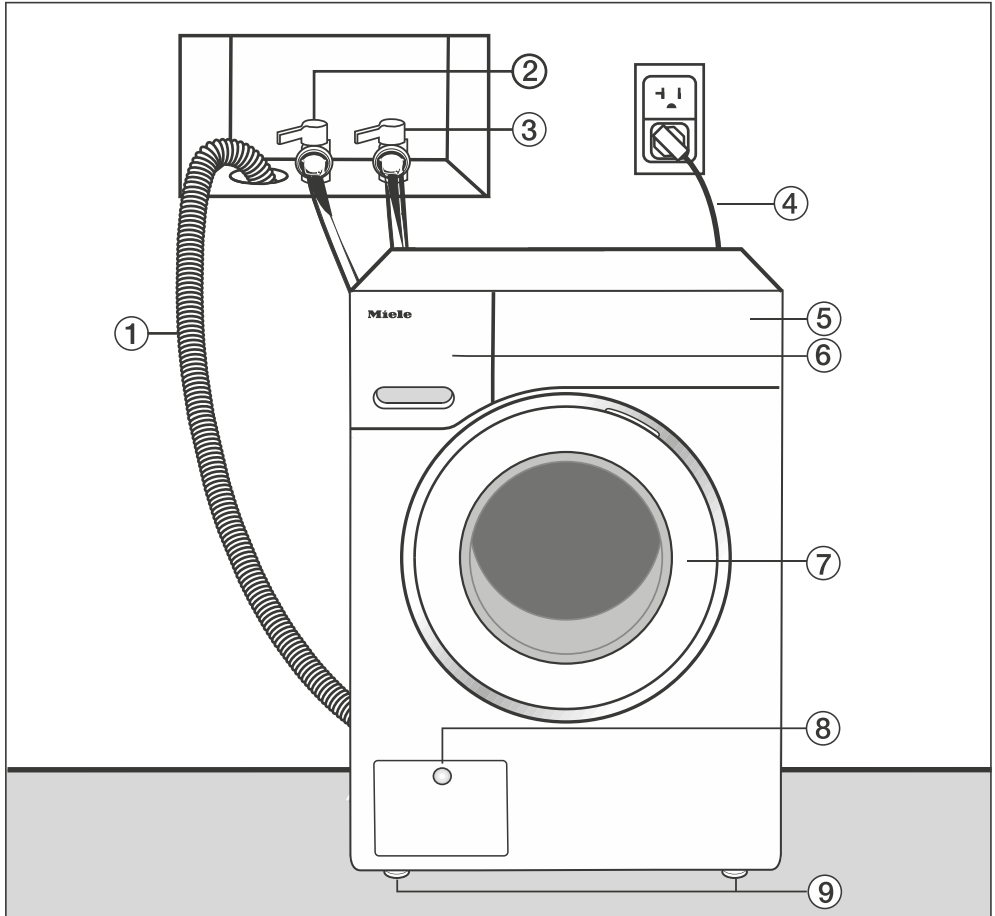

- ① Drain hose
- ② Hot-water inlet hose (pressure-proof to 1,015 psi/7,000 kPa)
- ③ Cold-water inlet hose (pressure-proof to 1,015 psi/7,000 kPa)
- ④ Electrical connection
- ⑤ Control panel
- ⑥ Detergent dispenser drawer
- ⑦ Door
- ⑧ Flap for drain filters, drain pump, and emergency release
- ⑨ Four height-adjustable feet

# Installation

## Rear view

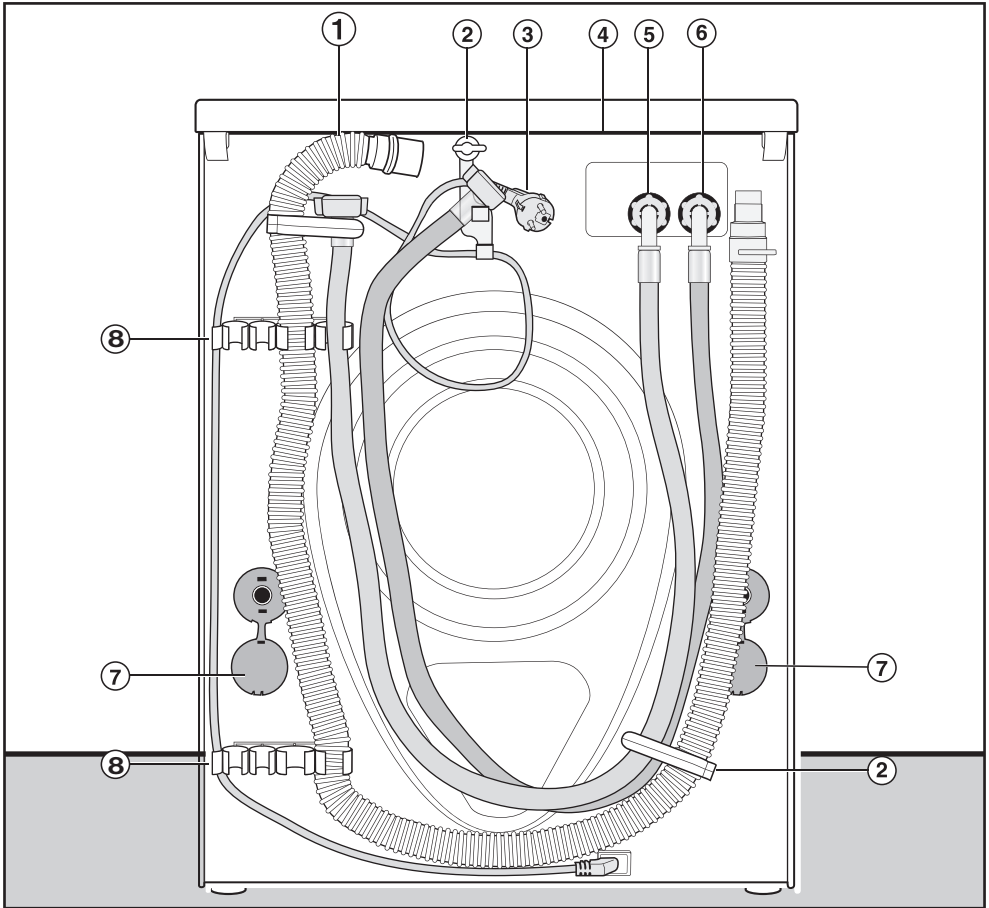

- ① Drain hose
- ② Transport clips for inlet and drain hoses and power cord
- ③ Electrical connection
- ④ Protruding lid for holding when moving the machine
- ⑤ Cold-water inlet hose (pressure-proof to 1,015 psi/7,000 kPa)
- ⑥ Hot-water inlet hose (pressure-proof to 1,015 psi/7,000 kPa)
- ⑦ Safety caps for shipping struts
- ⑧ Transport clips for inlet and drain hoses and for storing shipping struts when not in use

## Installation surface

A concrete floor is the most suitable installation surface for this machine. It is far less prone to vibration during the spin cycle than wooden floorboards or a carpeted surface.

Please note:

- The machine must be level and securely positioned.
- To avoid vibrations during spinning, the machine should not be installed on soft floor coverings.

If installing on a wooden joist floor:

- Install the unit on a 2 ft. x 2 ft. x 1 <sup>3</sup>/<sub>16</sub>" (61 x 61 x 3 cm) plywood base. Ideally the base should be large enough to span several joists and should be anchored to the joists and not just the floor boards.

**Tip:** If possible, install the machine in a corner. This is usually the most stable part of the floor.

⚠ Injury can occur if the washing machine has not been adequately secured.

During installation, the washing machine must be secured on a raised plinth to be made available on site (concrete or brick), in order to ensure it cannot fall or slip.

Secure the washing machine using a clamp/fastening bracket (MTS floor mounting kit – available from your Miele dealer or Miele Technical Service).

## Transporting the washing machine to its installation site

⚠ Danger of injury due to unsecure lid.

The fixings at the back of the lid may become brittle due to external circumstances. There is a danger of the lid being pulled off when carrying the appliance.

Before carrying the appliance, check that the lid is secure where it protrudes at the back of the appliance.

- Carry the washing machine by the front feet and by the lid where it protrudes at the back of the appliance.

## Removing the shipping struts

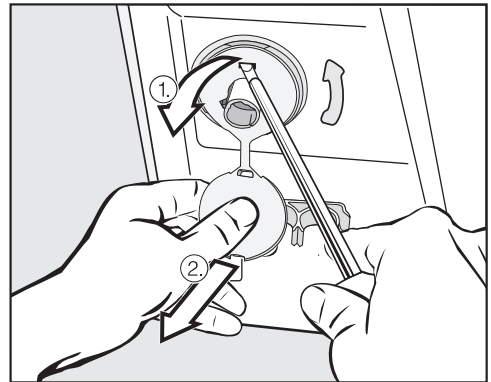

- Remove the left and right covers.
  1. Pull off the shipping strut covers and
  2. then use a screwdriver to release the catches at the top and bottom.

# Installation

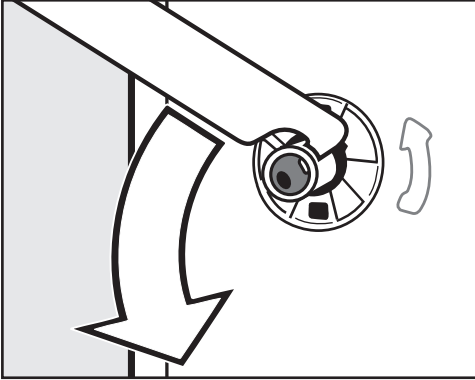

■ Using the wrench supplied, turn the left-hand shipping strut 90°, then

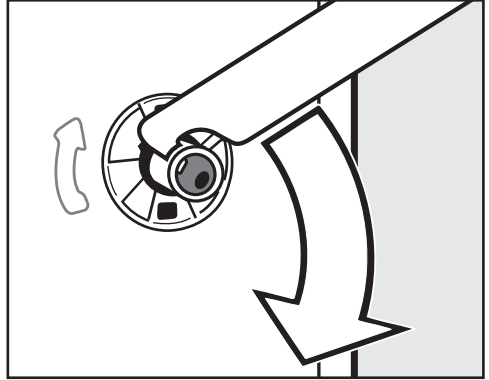

■ Turn the right-hand shipping strut 90°, then

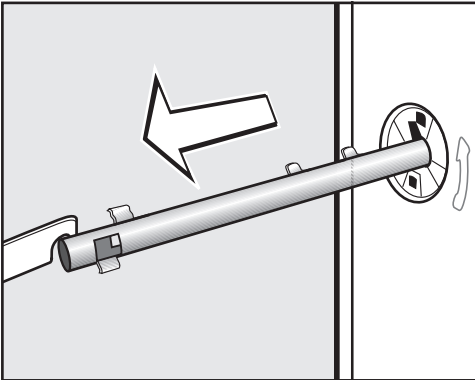

■ withdraw the shipping strut.

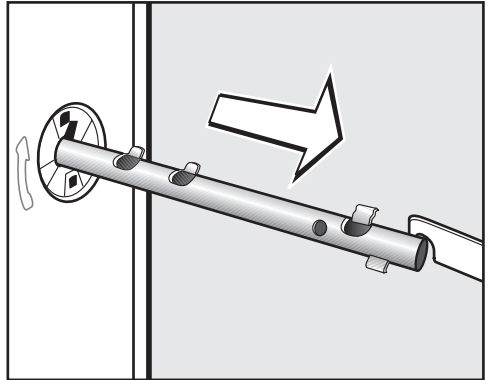

■ withdraw the shipping strut.

 Risk of injury from sharp edges. There is a risk of injury from reaching into holes that are not covered. Cover the holes for the shipping struts after they have been removed.

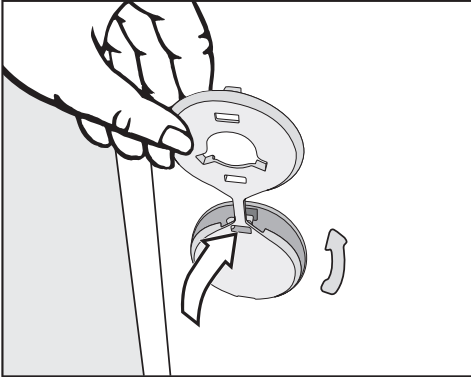

- Fit the covers onto the holes.

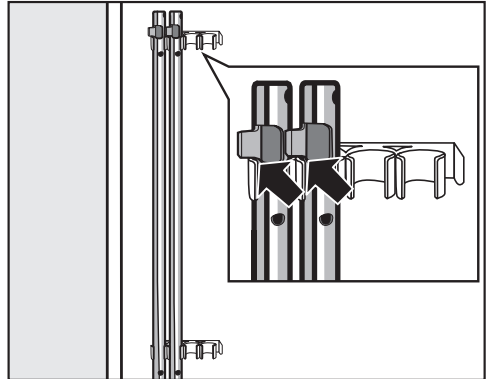

- Secure the shipping struts to the back of the washing machine. Make sure that the top catch is located above the holder.

 Risk of damage from incorrect transport.

The washing machine may become damaged if moved without the shipping struts in place.

Keep the struts in a safe place. Fit them again if the machine is to be moved (e.g., when moving house).

## Refitting the shipping struts

Refitting is carried out by reversing the procedure.

# Installation

## Leveling the machine

The washing machine must stand perfectly level on all four feet to ensure safe and proper operation.

Incorrect installation may increase electric and water consumption and may cause the machine to move about.

## Unscrewing and adjusting the feet

The four adjustable screw feet are used to level the washing machine. All four feet are screwed in when the machine is delivered.

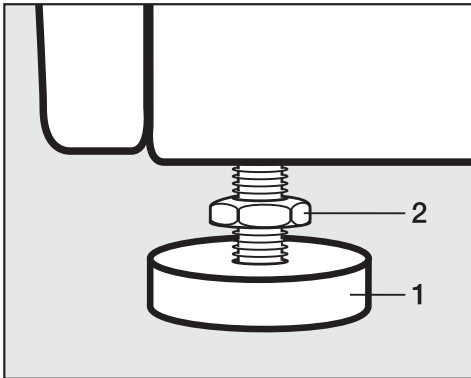

- Using the wrench supplied, turn counter nut **2** in a clockwise direction. Then turn counter nut **2** together with foot **1** to unscrew.

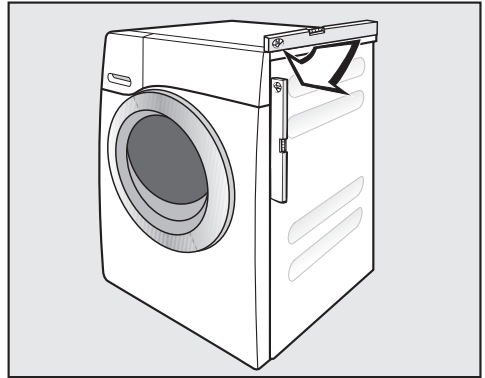

- Use a spirit level to check that the washing machine is standing level.
- Hold foot **1** securely with a pipe wrench. Turn counter nut **2** again using the wrench supplied until it sits firmly up against the housing.

⚠ Risk of damage due to incorrectly aligned washing machine.

There is a danger of the washing machine moving about if the feet are not secured.

Turn all four counter nuts for the feet until they sit firmly up against the housing. Please also check this for the feet which did not need adjustment.

## Additional installation requirements

The washing machine must be installed in accordance with the relevant local regulations.

**⚠** Damage resulting from failure to remove the transit bars.

Failure to remove the shipping struts can result in damage to the washing machine and to adjacent cabinetry or appliances.

Remove the shipping struts as described in “Installation and connection”.

## Installing under a countertop

**⚠** Risk of electric shock due to exposed cables

There is a risk of coming into contact with live parts while the lid is removed.

Do not remove the washing machine lid.

This washing machine (with lid intact) can be pushed under a worktop if there is space to do so.

## Setting up the cabinet

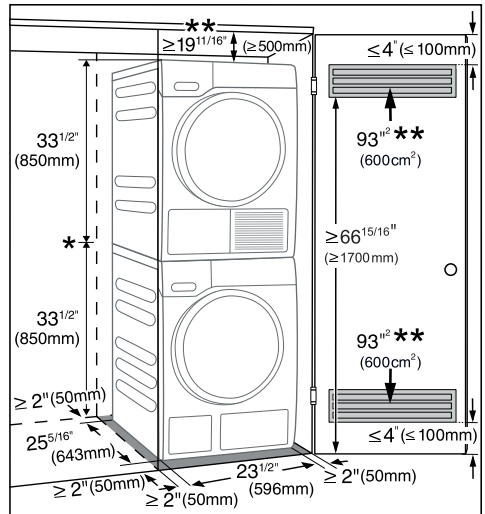

\* Height with Stacking Kit  
 WTV502 = 67 <sup>3</sup>/<sub>8</sub>" (1711 mm)  
 WTV512 = 71 <sup>1</sup>/<sub>8</sub>" (1806 mm)

\*\* If it is not possible to fulfill the dimension specification you may have longer drying and process time.

# Installation

## For closets at room height

You can also insert a ventilation opening at the top of the closet. In addition, you must provide an opening on the bottom side of the door.

**⚠ Risk of damage due to overheating of the washing machine.**

The air supply must not be hindered by an additional closet or shelf.

Please ensure that air is able to circulate freely at the top of the closet.

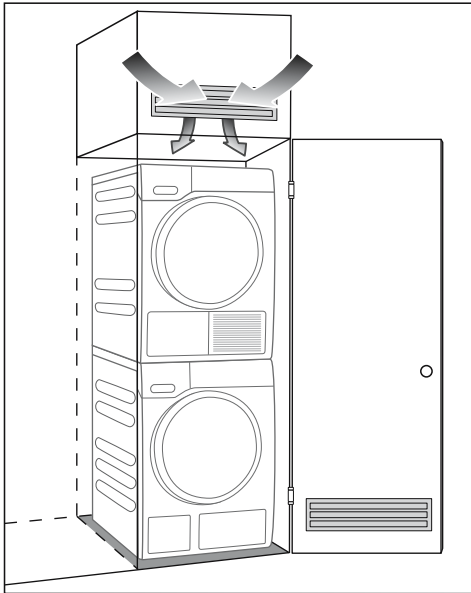

## Product Dimensions

### Dimensions

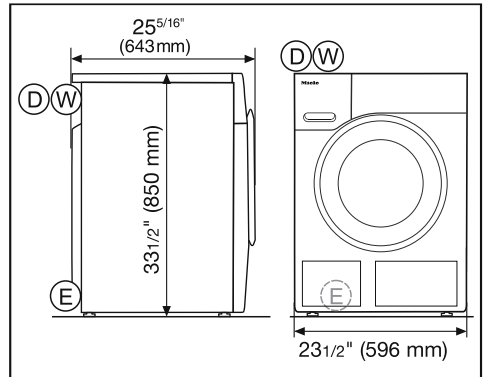

- ⓓ = 4.9 ft (1.50 m) drain hose with connection to the top left on the rear
- ⓔ = 6.5 ft (2.00 m) electrical cord with plug for 120 V, 15 A (NEMA 5-15 configuration) to the top left on the rear
- Ⓦ = 5.2 ft (1.60 m) warm and cold-water intake hoses to the top left on the rear

## Installation on a plinth

- WTS 510 (only available in white)

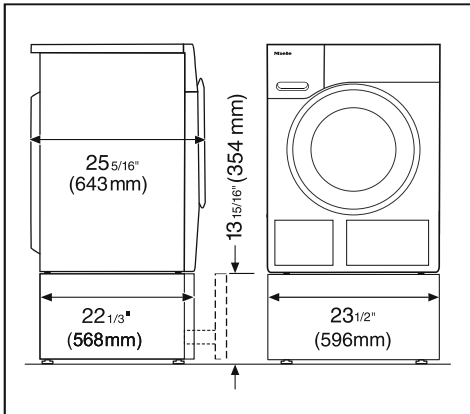

## Washer-dryer stack

- WTV 512 and WTV 502 washer-dryer stacking kit

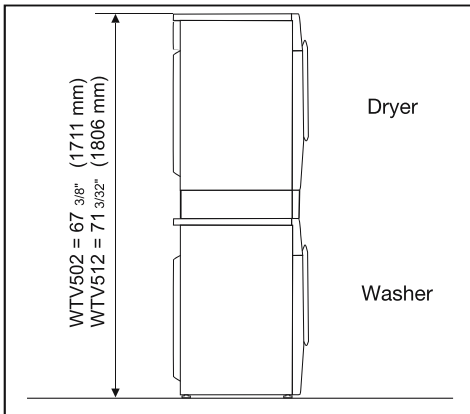

# Installation

---

## The water protection system

The Miele water protection system protects all parts of the washing machine and its surroundings from water damage.

The system consists of the following main components:

- the inlet hose
- the electronic module and drainage and overflow protection
- the drain hose

### Inlet hoses

- Protection against the hoses bursting

The inlet hose can withstand pressure of more than 1,015 psi (7,000 kPa).

## Electronic module and washing machine housing

- Sump: Any leaking water is collected in a sump in the base of the machine. A float switches off the water inlet valves, preventing any more water from flowing into the machine and water in the suds container is pumped away.
- Overflow protection: This prevents the washing machine taking in too much water. If the water level exceeds a certain level, the drain pump switches on and pumps the excess water away in a controlled way.

### Drain hose

The drain hose is protected by a ventilation system which prevents the washing machine from being emptied completely.

## Water intake

The washing machine can be connected to a portable water supply. A non-return valve is not needed unless required by building code.

The washing machine has ½" (13 mm) pressure hoses with ¾" (19 mm) female hose thread connections. If there is no water hookup, contact a plumber to install a connection. Make sure that the sealing ring is seated properly on the hose connector.

Replace the hose only with a genuine Miele hose, or with a hose able to withstand up to 145 psi (10.000 kPa) pressure. The water valve connector must also be able to withstand 145 psi (10.000 kPa).

The bolted connection is under water pressure. Open the water supply slowly to check for leaks. Adjust the rubber seal and the bolted connection if necessary.

## Maintenance

Only use a genuine Miele hose that has been tested to withstand pressure of at least 1,015 psi (7,000 kPa) should you ever need a replacement.

 A filter is located in the open end of the inlet hose and another in the intake point to protect the inlet valve. Neither filter may be removed.

# Installation

---

## Water drainage

The suds are drained through a drain pump with a 3.2 ft (1 m) delivery head. For the water to drain freely, the hose must be installed free of kinks.

If required, the hose can be extended to a length of up to 16.4 ft (5 m). Accessories are available from your Miele dealer or the Miele Technical Service.

### Drainage options:

1. Directly into a sink: Lay the hose around the edge of the sink and secure the drain hose so that it does not slip (e.g., by securing the drain hose to the faucet).
2. In a standpipe: Insert the drain hose into standpipe with dimensions of 1½" (Ø 4 cm). Secure the drain hose carefully to make sure it cannot slip.
3. In a floor drain: The washing machine is designed with a gap (anti-siphon system) which means that a minimum drain height is not required.

## Electrical connection

### GROUNDING INSTRUCTIONS

This appliance must be grounded. In the event of a malfunction or breakdown, grounding will reduce the risk of electric shock by providing a path of least resistance for electric current. This appliance is equipped with a cord having an equipment-grounding conductor and a grounding plug. The plug must be plugged into an appropriate outlet that is properly installed and grounded in accordance with all local codes and ordinances.

**WARNING** – Improper connection of the equipment-grounding conductor can result in a risk of electric shock. Check with a qualified electrician or service representative if you are in doubt as to whether the appliance is properly grounded.

Do not modify the plug provided with the appliance; if it will not fit the outlet, have a proper outlet installed by a qualified electrician.

## ELECTRICAL INSTRUCTIONS

This installation should be performed by an experienced and qualified technician, in accordance with local codes and regulations.

The washing machine is supplied with a 5' 3" (1.6 m) long, 3 wire cord, ending in a NEMA 5-15P plug, ready for connection to a 120 V, 15 A, 60 Hz, AC power supply.

The proper outlet can be purchased from an electrical supply dealer.

## Technical data

---

Height	33 7/16" (850 mm)
Width	23 7/16" (596 mm)
Depth	25 1/16" (636 mm)
Depth with door open	41 1/2" (1054 mm)
Height for building under	32 5/16" (+5/16"/-1/16") (820 mm)
Width for building under	23 5/8" (600 mm)
Weight	Approx. 220.5 lb (100 kg)
Capacity	17.6 lb (8 kg) dry laundry
Connection voltage	See data plate
Power rating	See data plate
Fuse	See data plate
Minimum flow pressure	14.5 psi (100 kPa)
Maximum flow pressure	145 psi (1,000 kPa)
Water inlet hose length	63" (1.6 m)
Drain hose length	59 1/16" (1.5 m)
Power cord length	78 3/4" (2 m)
Maximum drain pump head height	39 3/8" ( 1 m)
Maximum drain hose length	196 7/8" ( 5 m)
LEDs	Class 1
Test certificates awarded	See data plate
Frequency band	2.412 GHz – 2.462 GHz
Maximum transmitting power	< 100 mW

You can use the settings to alter the washing machine's electronics to suit changing requirements.

The settings can be altered at any time.

## Calling up settings

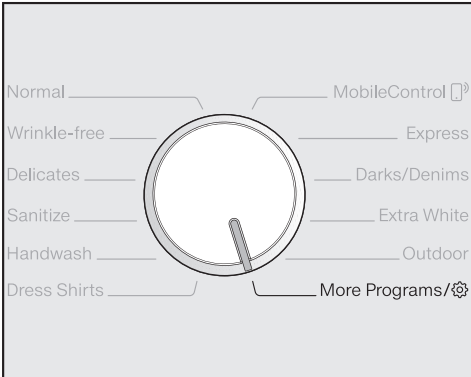

- Turn the program selector to *More programs/⚙️*.



- Touch the ∨∧ sensor buttons until the following appears in the display:



- Confirm with the *OK* sensor button.



You are now in the *Settings* submenu.

## Selecting settings

- Touch the ∨∧ sensor buttons until the setting you want appears in the display.
  - The ∨ sensor button scrolls down the list.
  - The ∧ sensor button scrolls up the list.
- Touch the *OK* sensor button to select the setting displayed.

## Changing a setting

- Touching the ∨∧ sensor buttons will call up the different options for the setting.

The option which is selected will have a check ✓ next to it.

- When the option you want appears in the display, touch the *OK* sensor button to activate it.

## Closing the Settings menu

- Turn the program selector.

# Settings

---

## Language

The display can be set to appear in one of several different languages.

The flag  after the word *Language* acts as a guide in case a language which is not understood is set.

The language selected is saved to memory.

## Buzzer volume

The buzzer sounds to let you know the program has finished. The buzzer can be set to be louder or quieter.

### Options

- Off
- ■■■■■■■■ (quiet)
- ■■■■■■■■ (loud) (default setting)

## Keypad tone

Each touch of a sensor button is confirmed with an audible tone.

### Options

- Off
- ■■■■■■■■ (quiet)
- ■■■■■■■■ (default setting)
- ■■■■■■■■ (loud)

## Welcome tone

The volume for the greeting tone can be set to one of seven different settings.

### Options

- Off
- ■■■■■■■■ (quiet)
- ■■■■■■■■ (default setting)
- ■■■■■■■■ (loud)

## Code

The PIN code prevents the washing machine being used without your knowledge.

### Options

- Activate  
The code is 125 and can be activated.  
When the code has been activated, you have to enter a code after switching the washing machine on. Otherwise the washing machine cannot be operated.
- Change  
You can enter a code of your own.

 Make a note of the new PIN code. If you forget the code, the washing machine will need to be unlocked by Miele Technical Service.

- Deactivate  
For using the washing machine without entering the code. This only appears if the PIN code has been activated previously.

## Unit

The temperature and spin speed can be displayed in 3 different forms.







### Options

- Clear text (default setting)  
The values are displayed as words.
- °C + rpm  
The values are displayed as figures in the units °C and rpm.
- °F + rpm  
The values are displayed as figures in the units °F and rpm.

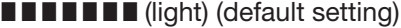
## Brightness

You can set the brightness of the display, the sensor buttons, and the dimmed sensor buttons.

### Options

- Display  
Controls the brightness of the display.
  -  (dark)
  -  (light) (default setting)
- Buttons active  
Controls the brightness of the activated sensor buttons.
  -  (dark)
  -  (default setting)
  -  (light)
- Buttons inactive  
Controls the brightness of the sensor buttons that can be activated.
  -  (dark)
  -  (default setting)
  -  (light)

**Tip:** Ensure that there is a big difference in brightness between the activated and dimmed sensor buttons. This makes it easier to operate the appliance.

# Settings

---

## Display switch-off

The display and the sensor button lighting is switched off to save energy. The *Start/Stop* sensor button flashes slowly.

### Options

- On  
Lighting switches off after 10 minutes.
- On (not crnt prog) (default setting)  
Lighting remains switched on throughout the program. The lighting switches off 10 minutes after the program has ended.
- Off  
The lighting remains switched on.

## Program info

You can select the information that will be displayed temporarily once a program has been selected in the display.

### Options

- Program name (default setting)  
The program name is shown in the display for several seconds.
- Prog. & Max load  
The program name and the maximum load is shown in the display for several seconds.
- Off  
Directly after the program has been selected, the standard display is shown with temperature, spin speed, and program duration.

## Memory

The washing machine will save the last settings (temperature, spin speed, and some of the extra options) selected for a wash program after the program has started.

When the program is chosen again, the saved settings will appear on the display.

Memory is deactivated as standard.

## Water intake

You can program 3 options for the water inlet. The water inlet is controlled by the two inlet hoses.

### Options

- Cold water  
The washing machine will be operated with cold water only.
- Hot water  (default setting)  
Hot water is used in the main wash to save energy.  
You can heat up your water with cheaper, primary energy sources, e.g., gas, solar power, oil. The temperature must be below 140°F (60°C.)

 For technical reasons, the washing machine **must** always be connected to cold water.

## Long p-wash Normal

If you require a longer pre-wash, you can extend the standard pre-wash time of 25 minutes.

### Options

- No increase (default setting)  
25-minute pre-wash
- + 6 min  
31-minute pre-wash
- + 9 min  
34-minute pre-wash
- + 12 min  
37-minute pre-wash

## Soak duration

You can set a duration for the soak process of between 30 minutes and 6 hours.

A duration can be selected in 30-minute increments. When the *Soak extra* option is selected, the laundry will be soaked for the duration selected.

The machine is delivered with a duration of 0:30 hours.

## Gentle action

With gentle action activated, drum rotation is reduced. In this way, lightly soiled items can be washed more gently.

Gentle action can be activated for the *Normal* and the *Wrinkle-free* programs.

Gentle action is switched off in the default setting.

## Temp. reduction

At high altitudes water has a lower boiling point. Miele recommends activating the reduce temperature setting at altitudes of or above 6560 ft (2,000 m) to prevent water from boiling. The maximum temperature is reduced to 176°F (80°C), even if a higher temperature is selected.

The temperature reduction setting is switched off in the default setting.

# Settings

---

## Maximum rinse level

The water level in the rinse can be permanently set to the highest value.

This function is important for allergy sufferers as it achieves excellent wash results. The water consumption will be increased.

The function is switched off in the default setting.

## Suds cooling

Additional water flows into the drum at the end of the main wash to cool the suds down.

Suds cooling takes place when a Normal program with a temperature setting of *Hot+* or higher is selected.

Suds cooling should be activated:

- To prevent the danger of scalding if the drain hose is hooked over the edge of a sink or basin.
- Where the drainage pipes do not comply with DIN 1986.

Suds cooling is switched off in the default setting.

## Low water pressure

If the water pressure is below 14.5 psi (100 kPa), the program will be canceled and the fault message *Drainage* See  will appear.

If the on-site water pressure cannot be increased, activating this function will prevent the program from being canceled.

Low water pressure is deactivated as standard.

## Anti-Crease

The Anti-crease function helps prevent creasing after the end of the program.

At the end of the program, the drum continues to turn for up to 30 minutes. The washing machine door can be unlocked and then opened at any time by touching the Start/Stop sensor button.

Anti-crease is switched on in the default setting.

## Miele@home

Control the networking of your washing machine with your WiFi network.

The following points may appear in the submenu:

### Set up

This message only appears if the washing machine has not yet been connected to a WiFi network.

Please refer to “Initial set-up” to set up the connection.

Deactivate (visible if Miele@home is activated)

Miele@home remains set up, the WiFi function is switched off.

Activate (visible if Miele@home is deactivated)

The WiFi function is reactivated.

Connection status (visible if Miele@home is activated)

The following values are displayed:

- The WiFi reception quality
- The network name
- The IP address

Set up again (visible if set up)

Resets the WiFi login (network) to immediately re-establish a new connection.

Reset (visible if set up)

- The WiFi is switched off.
- The WiFi connection will be reset to the default setting.

Miele@home is no longer set up. A new connection setup has to be carried out in order to use the Miele@home setting again.

# Settings

---

## Remote control

The Remote control setting is only visible if the Miele@home setting is set up and activated.

Once the Miele@mobile app has been installed on your mobile device, you can check the status of your washing machine from anywhere and start it remotely. You can also control it remotely via the *MobileControl* program.

You can switch off the Remote control setting if you do not want to operate the washing machine with your mobile device.

If Remote control is not switched on, the app can cause the program to be canceled.

Use the Delay Start button to set a time until you want to start the washing machine and start the Delay Start function (see “Delay Start/SmartStart”).

The washing machine will then start within the timeframe specified when it receives your signal.

If it has not received a start signal by the latest start time set, the washing machine will start automatically.

Remote control is activated as standard.

## SmartGrid

The SmartGrid setting is only visible if the Miele@home setting is set up and activated.

This function can be used for starting your washing machine automatically at a time when your energy supplier's energy costs are most economical.

Activating SmartGrid gives the *Delay Start* button a new function. You set the SmartGrid via the Delay Start button. The washing machine will then start within the timeframe specified by you when it receives a signal from your energy supplier.

If it has not received a signal from the energy supplier by the latest start time set, the washing machine will start automatically (see “Delay Start”).

SmartGrid is deactivated as standard.

## RemoteUpdate

The RemoteUpdate function updates the software in your washing machine.

The RemoteUpdate function is deactivated as standard.

If you do not install a RemoteUpdate, you can continue to use your washing machine in the usual way. However, Miele recommends installing RemoteUpdates.

### Activation

The RemoteUpdate menu option is only displayed and can only be selected if you have added your washing machine to your WLAN network (see “Miele@home” in the “Settings” chapter).

Miele's RemoteUpdate function can only be used if the washing machine is connected to a WLAN network and you have an account in the Miele@mobile app. The washing machine must be registered with your account in the app.

See the Miele@mobile app for terms and conditions of use.

Some software updates can only be carried out by Miele Service.

## Running a RemoteUpdate

If a RemoteUpdate is available for your washing machine, it will be displayed automatically for you.

You can choose to start the RemoteUpdate immediately or wait until later. If you select “delay start”, the prompt to run the RemoteUpdate will be displayed again the next time you switch on your washing machine.

The RemoteUpdate can take a few minutes.

Please note the following information about the RemoteUpdate function:

- You will only receive a message when a RemoteUpdate is available.
- Once a RemoteUpdate has been installed, it cannot be undone.
- Do not switch off the washing machine during a RemoteUpdate. Otherwise, the RemoteUpdate will be aborted and will not be installed.

# Settings

---

## Bleach

You can activate the automatic addition of chlorine bleach at the end of the main wash.

Chlorine bleach may only be used in some programs. See “5. Adding detergent – Using chlorine bleach” for more detailed information.

Activating chlorine bleach extends the program duration by approximately 10 minutes.

The washing machine is delivered with the chlorine bleach setting deactivated.

## Detergent

### UltraWhite

- Multi-purpose powder detergent
- For white and light-colored laundry as well as heavily soiled cotton items
- Effective stain removal even at low temperatures

### UltraColor

- Liquid detergent for colored items
- For colored and dark textiles
- Protects bright colors from fading
- Effective stain removal even at low temperatures

### Wool and delicates detergent

- Liquid detergent for delicates
- Particularly suitable for woollen and silk textiles
- Cleans at temperatures as low as 70°F (20°C), helps retain the shape of delicate items and protect colors

## Speciality detergents

Speciality detergents are available as capsules  in convenient single dose amounts or in a handy bottle.

### Outdoor

- Liquid detergent for outdoor and performance clothing
- Cleans with care and is gentle on colors
- With lanolin to care for and condition membrane fabric

### Sport

- Liquid detergent for sportswear and fleece garments
- Neutralizes unpleasant odors
- Retains the shape of the textiles

### Downs

- Liquid detergent suitable for pillows, sleeping bags, and Down Filled Items
- Retains the elasticity of down and feather-filled items
- Retains the breathability of Down Filled Items
- Prevents down filling clumping together

### WoolCare

- Liquid detergent for Woolens and delicates
- Includes a special wheat protein conditioning formula
- Helps prevent pilling
- Gentle on colors
- Only available as capsules 

### SilkCare

- Liquid detergent for silks
- Contains a special silk protein conditioning formula
- Gentle on colors
- Only available as capsules 

# Optional accessories

---

## Fabric care

Fabric care agents are available as capsules ☼ in convenient single dose amounts or in a handy bottle.

### Proofing agent

- For reproofing microfiber textiles, e.g., rain coats
- Retains the breathability of textiles

### Fabric softener

- Fresh, natural fragrance
- Makes laundry soft to handle

## Additive

### Booster

- For removing stains
- For white and colored laundry
- Available as capsules ☼ in convenient single dose amounts

## Machine care

### Detergent

- For cleaning the washing machine thoroughly and effectively
- Removes grease, bacteria, and associated unpleasant odors
- Use 1–3 times per year

### Descaling agent

- Removes heavy lime scale deposits
- Mild and gentle with natural citric acid

### Water softener tablets

- Reduces quantities of detergent for hard water
- Less detergent residue in textiles
- Less chemicals in waste water due to reduced amount of detergent





**Please have the model and serial number  
of your appliance available when  
contacting Technical Service.**

---

The Miele logo consists of the word "Miele" in a bold, white, serif font, set against a solid black rectangular background.

## **U.S.A.**

**Miele, Inc.**

### **National Headquarters**

9 Independence Way  
Princeton, NJ 08540  
Phone: 800-843-7231  
Fax: 609-419-4298  
[www.mieleusa.com](http://www.mieleusa.com)

### **Technical Service & Support**

Phone: 800-999-1360  
Fax: 888-586-8056  
[TechnicalService@mieleusa.com](mailto:TechnicalService@mieleusa.com)

### **International Headquarters**

Miele & Cie. KG  
Carl-Miele-Straße 29  
33332 Gütersloh  
Germany

## **Canada**

**Importer  
Miele Limited**

### **Headquarters and Miele Centre**

161 Four Valley Drive  
Vaughan, ON L4K 4V8  
[www.miele.ca](http://www.miele.ca)

### **Customer Care Centre**

Phone: 800-565-6435  
905-532-2272  
[customercare@miele.ca](mailto:customercare@miele.ca)

WWF 060

en-US

M.-Nr. 10 669 371 / 02